**UNITED STATES MARINE CORPS
THE BASIC SCHOOL
MARINE CORPS TRAINING COMMAND
CAMP BARRETT, VIRGINIA 22134-5019**

**COMBAT SERVICE
SUPPORT FUNCTIONS
B2G0353XQ
STUDENT HANDOUT**

Combat Service Support

Introduction

Our doctrine defines logistics as the science of planning and carrying out the movement and maintenance of forces. Logistics provides the resources of combat power, positions those resources on the battlefield, and sustains them throughout the execution of operations. Logistics encompasses a wide range of actions and relationships among those actions, as well as the resources that make those actions possible. These actions are all given purpose and definition by the larger art of war, of which logistics is a critical and inseparable part. (MCDP 4) You will interact with logistical planning and, in particular, combat service support planning in some way, shape or form regardless of your job specialty after you leave The Basic School.

Importance

This lesson is designed to give you a brief overview of logistic activities spanning the three levels of war. This lesson will provide more detail on tactical-level logistics with an emphasis on assessing and requisitioning requirements, initiating and conducting maintenance, and understanding planning considerations for the classes of supply. This class will provide you with the information needed to understand how logistical support is planned and executed and where you fit into that process as an officer.

In This Lesson

This lesson covers the following topics:

Topic	Page
Differences Between Logistics and CSS	4
Principles of Logistics	5
Functions of Tactical Logistics	6
Planning Considerations for Functions of Tactical Logistics	8
Support Capabilities Across the MAGTF	16
Marine Division CSS Capabilities	19
Marine Aircraft Wing CSS Capabilities	20
Marine Logistics Group CSS Capabilities	21
Facilitating CSS in the FMF	23
Utilizing Planning Factors and Determining Requirements	29
Sample Problems: Using Planning Factors	32

Learning ObjectivesTerminal Learning Objectives:

TBS-CSS-2302 Given a mission with logistics support requirements, initiate a logistics support request to ensure the unit is prepared for the mission.

TBS-CSS-2101 Given a scenario and unit equipment, apply small unit maintenance concepts to ensure the equipment is prepared for future operations.

Enabling Learning Objectives:

TBS-CSS-2101a Given an evaluation, and without the aid of references, identify the levels of maintenance without omission.

TBS-CSS-2101c Given a scenario, and without the aid of reference, identify the phases of maintenance action, without omission.

TBS-CSS-2101d Given unit maintenance requirements, including weapons, vehicles, and equipment, determine corrective action options to achieve the fastest possible return to service within proper channels without omission.

TBS-CSS-2101e Given an evaluation and without the aid of references, identify the categories of maintenance without omission.

TBS-CSS-2302a Given an evaluation, identify functions of tactical level logistics without omission.

TBS-CSS-2302b Given an evaluation, identify classes of supply without omission.

TBS-CSS-2302c Given a scenario, apply logistical planning considerations to ensure a unit is prepared for a mission.

TBS-CSS-2302d Given a scenario, identify characteristics of logistical support missions without omission.

Differences Between Logistics and Combat Service Support

Doctrinal definition	Logistics encompasses all actions required to move and maintain forces . This includes the acquisition and positioning of resources as well as the delivery of those resources. (MCDP-4)
Combat Service Support	The terms “logistics” and “combat service support” are often used interchangeably, but there is a distinction. Logistics is the larger of the two concepts and it serves as one of the six warfighting functions. Combat service support is the activity, which actually provides services and supplies to the combat forces. (MCDP-4) Since many CSS activities are conducted within the tactical-level of logistics, the two terms are commonly used interchangeably in the operating forces.
Logistics Continuum	Strategic, operational, and tactical logistics parallel and complement the levels of war. Strategic logistics supports the organizing, training and equipping of forces needed to further the national interest. Operational logistics links tactical requirements and strategic capabilities to accomplish operational goals and objectives. Tactical logistics includes organic unit capabilities and combat service support activities required to support military operations. (MCW P 4-11).

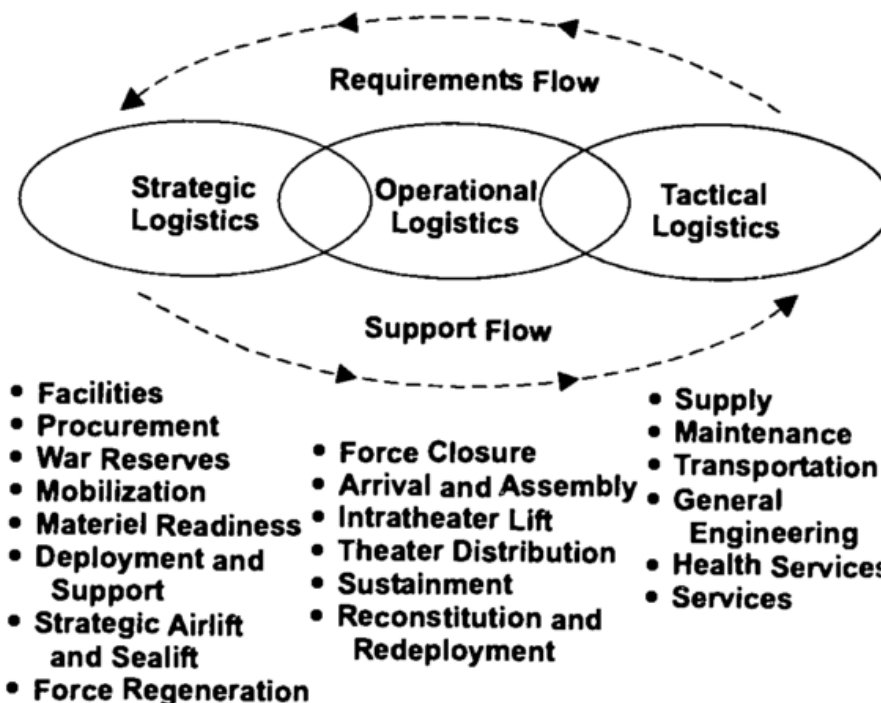

Principles of Logistics

Principles of Logistics Support. These principles **apply to all three levels of logistics**, and like the principles of war, are guides for planning, organization, managing, and executing the provision of logistical support to Marines in the fight. These principles are not rigid rules. They will not apply at all times and should be interpreted as a guide for analytical thinking and prudent planning. (MCW P 4-1)

Responsiveness	Responsiveness is the right support at the right place at the right time. Among the logistics principles, responsiveness is the keystone . All other principles become irrelevant if logistics support does not support the commander's concept of operations.
Simplicity	Fosters efficiency in both the planning and execution of logistics operations through establishment of priorities and standardized procedures and use of mission-type orders.
Flexibility	The ability to adapt logistics structure and procedures to changing situations, missions, and concepts of operation. Includes the concepts of alternative planning, anticipation, reserve assets, redundancy, forward support of phased logistics and centralized control with decentralized operations.
Economy	Providing sufficient support at the least cost without impairing mission accomplishment or jeopardizing lives. At some level and to some degree, resources are always limited. Marines employ this principle by prioritizing limited resources and allocating them sufficiently to achieve success without imbalance and inordinate excess.
Attainability	The ability to provide the minimum , essential supplies and services required to begin combat operations . An operation should not begin until minimum essential levels of support are on hand. Logisticians develop the concept of logistics support, complete their estimate, and initiate resource identification on basis of supported units requirements.
Sustainability	The ability to maintain logistics support to all users throughout the area of operations for the duration of the operations. Focuses the commander's attention on the long-term objective and capabilities of the force.

Principles of Logistics (Continued)

Survivability The capacity of the organization to protect its forces and resources. Logistics units and installations are **high-value targets that must be guarded** to avoid presenting the enemy with a critical vulnerability. The allocation of reserves, development of alternative sources, and phasing of logistics support contribute to survivability.

Functions of Tactical Logistics

Functional Area	Description	Sub-Function
Supply	Supply is a cyclic process of acquiring and issuing materiel to supported units. This materiel may be consumable or durable materiel, components, and end items. Logisticians usually calculate requirements for each class and subclass of supply. See MCW P 4-11.7, <i>MAGTF Supply Operations</i> , for additional information.	<ul style="list-style-type: none"> • Determination of requirements • Procurement • Storage • Distribution • Salvage • Disposal
Maintenance	Maintenance involves those actions taken to keep materiel in serviceable condition (preventive maintenance) and actions required to return materiel to serviceable condition (corrective maintenance).	<ul style="list-style-type: none"> • Inspection and classification • Service, adjustment and tuning • Testing and calibration • Repair • Modification • Rebuilding and overhaul • Reclamation • Recovery and evacuation
Transportation	Transportation is moving from one location to another using railways, highways, waterways, pipelines, oceans, and airways. Throughput is the amount of cargo and personnel passing through the transportation system.	<ul style="list-style-type: none"> • Embarkation • Landing Support • Port and terminal operations • Motor Transport • Air delivery • Freight/passenger transportation • Material handling equipment

Functions of Tactical Logistics (Continued)

Functional Area	Description	Sub-Function
General Engineering	General Engineering is distinct from combat engineering and is usually considered a CSS function. General Engineering assets at the tactical level may be used to reinforce or augment combat engineer organizations in specific situations for mobility, counter-mobility or survivability tasks.	<ul style="list-style-type: none"> • Engineer reconnaissance • Horizontal and vertical construction • Facilities maintenance • Demolition and obstacle removal • Explosive ordnance disposal • Bridging
Health Services	Health services support seeks to minimize the effect that wounds, injuries and disease have on unit effectiveness and morale. Health services support accomplishes this by preventive medicine and by the establishment of a system, which provides medical support from the point of wounding, injury or illness through evacuation.	<ul style="list-style-type: none"> • Health maintenance • Casualty collection • Casualty treatment • Temporary casualty holding • Casualty evacuation
Services	Provides for the effective administration, management, and employment of military organizations. Services sub-functions are essentially administrative in nature. These are categorized as either command services, which are services provided to Marines by their individual commands, or CSS services, which are services provided by a CSS unit.	<p>Command Services:</p> <ul style="list-style-type: none"> • Personnel administration • Religious ministries support • Financial management • Communications • Billeting • Messing • Band • Morale, Welfare and Recreation <p>CSS Services:</p> <ul style="list-style-type: none"> • Disbursing • Postal • Exchange services • Security support • Legal services support • Civil affairs support • Graves registration

Planning Considerations for Functions of Tactical Logistics

Let's review how our warfighting publication (MCW P 4-11) covering tactical logistics guides us through thinking about the six functions of tactical logistics (**Supply, Maintenance, Transportation, General Engineering, Health Services, and Services**) as related to mission planning.

Function	Planning Considerations		
Supply	<p>(1) <i>Supply cycle. The supply process is a cycle that involves procurement, use, and replenishment of supply items. The cycle period for each supply item varies based on usage rate, storage and transport capacity, and procurement lead-time. Normally, the shorter the cycle, the more intensive the management and transportation effort becomes. Conversely, items with longer cycles require forward planning and more storage. (MCW P 4-11, p. 4-7)</i></p> <p>Simply put, all Marines need to be conscious of the supply chain linking the supply items they use to the methods of storage and procurement that generate and store supply items prior to use. Planners also need to be aware of the consumption rates that vary between various items used in the Fleet and how to best manage the supply and procurement process for these items.</p> <p>(2) <i>Phases of Supply Support. The LCE and ACE perform the tactical supply that affects the sustainability of the MAGTF. Tactical supply extends from receipt of finished supplies through issue for use or consumption by the user. The LCE and ACE control the supply process through forecasting, requisitioning, receiving, storing, stock controlling, shipping, disposition, identifying, and accounting procedures established in directives. Ideally, the procedures used in peacetime are the same as those used in wartime. Combat requirements also necessitate rapid processing of requests submitted by unusual methods. (MCW P 4-11, p. 4-7)</i></p>		
	Class of Supply	Description	Subclass
	Class 1	Subsistence	A (Air, inflight rations) C (Combat rations) R (Refrigerated subsistence) S (Non-refrigerated)
	Class 2	Clothing, individual equipment, tentage, organizational tool sets/kits, hand tools, administrative and housekeeping supplies and equipment	B (Ground support material) E (General supplies) F (Clothing/textiles) M (Weapons) T (industrial supplies)

Planning Considerations for Functions of Tactical Logistics (Continued)

Function	Planning Considerations		
Supply (Continued)	Class of Supply	Description	Subclass
	Class 3	Petroleum, oils and lubricants including petroleum fuels, lubricants, hydraulic and insulating oils, preservatives, liquid and compressed gases, bulk chemical products, coolants, de-icing and antifreeze compounds and the components and additives of each product.	A (Air) W (Ground)
	Class 4	Construction materiel including installed equipment and all fortification and barrier materiel	None
	Class 5	Ammunition of all types – including chemical/biological/radiological and special weapons, bombs, explosives, mines, fuses, detonators, pyrotechnics, missiles, rockets, propellants and other associated items	A (Air) W (Ground)
	Class 6	Personal demand items and nonmilitary sales items	None
	Class 7	Major end items – the final combination of end products assembled and configured in their intended form and ready for use (launchers,	A (Air) B (Ground support materiel) D (Administrative vehicles) G (Electronics) K (Tactical vehicles) L (Missiles)

Planning Considerations for Functions of Tactical Logistics (Continued)

Function	Planning Considerations		
Function Supply (Continued)	Class of Supply	Description	Subclass
	Class 7	tanks, mobile machine shops, vehicles)	M (Weapons) N (Special Weapons)
	Class 8	Medical materiel – to include repair parts unique to medical materiel	A (Medical and / or dental) B (Blood and blood products)
	Class 9	Repair parts, which include components and kits, assemblies, and subassemblies (repairable and non- repairable) required for maintenance support of all equipment)	A (air) B (ground support materiel) D (administrative vehicles) G (electronics) K (tactical vehicles) L (missiles) M (weapons) N (special weapons) T (industrial supplies)
	Class 10	Nonmilitary material – to include material to support nonmilitary programs (agriculture and economic development) that is not included in Classes 1-9.	None.

Maintenance

MARADMIN 159/13 establishes that maintenance capability is defined within two levels of maintenance: **Field** and **Depot**. The distinction between the two levels is based on the maintenance tasks performed within each.

- **Field level** maintenance is any maintenance that does not require depot maintenance capability and is performed by equipment crew and equipment operators and mechanics/ technicians within Marine Corps organizations and activities, and/or by approved commercial/contract sources. Two categories of maintenance capability exist within the field level:
 - **Organizational**
 - **Intermediate**

Planning Considerations for Functions of Tactical Logistics (Continued)

Maintenance

A unit may conduct any field level maintenance task for which it is manned, trained and equipped. To manage maintenance effectively, commanders must understand their maintenance responsibilities and the maintenance responsibilities of those units in support. (MCWP 4-24)

Typically, maintenance in the organizational category is conducted by equipment operators, crews and unit equipment technicians at the using unit level. Maintenance in the intermediate category typically occurs at units task- organized to provide specialized maintenance support. However, Marine commanders in any unit may direct the conduct of either organizational or intermediate category maintenance tasks if their unit has the trained personnel and equipment the task requires on hand.

- **Depot level** maintenance is not defined by location, although some Marines are familiar with the Marine Corps Logistics Bases (MCLBs) located in Albany, GA and Barstow, CA as locations where depot-level maintenance occurs. The Marine Corps organic depots, other service depots, commercial industrial facilities, and/or original equipment manufacturers may perform depot maintenance related activities throughout the logistics chain framework; however, in all cases depot maintenance will be specifically authorized and directed. (MARADMIN 159/13) Equipment requiring depot-level maintenance typically requires a major overhaul or rebuild.
- The maintenance process consists of four maintenance phases. These phases include the **acceptance of equipment, equipment induction, active maintenance** and **maintenance closeout**.



- The **acceptance of equipment** phase is the initial step of the maintenance process. It consists of an acceptance inspection, scheduling, and assignment.
- **Equipment induction** is the physical commitment of a maintenance service request and associated equipment to a specific maintenance section. Induction of equipment into a specific shop is determined by the priority assigned during the equipment acceptance phase in accordance with the priority requested by the owning unit.

Planning Considerations for Functions of Tactical Logistics (Continued)

Maintenance

- Maintenance activity performed following equipment induction into a maintenance section constitutes the **active maintenance phase** and the beginning of the repair process. The following steps are included during active maintenance:

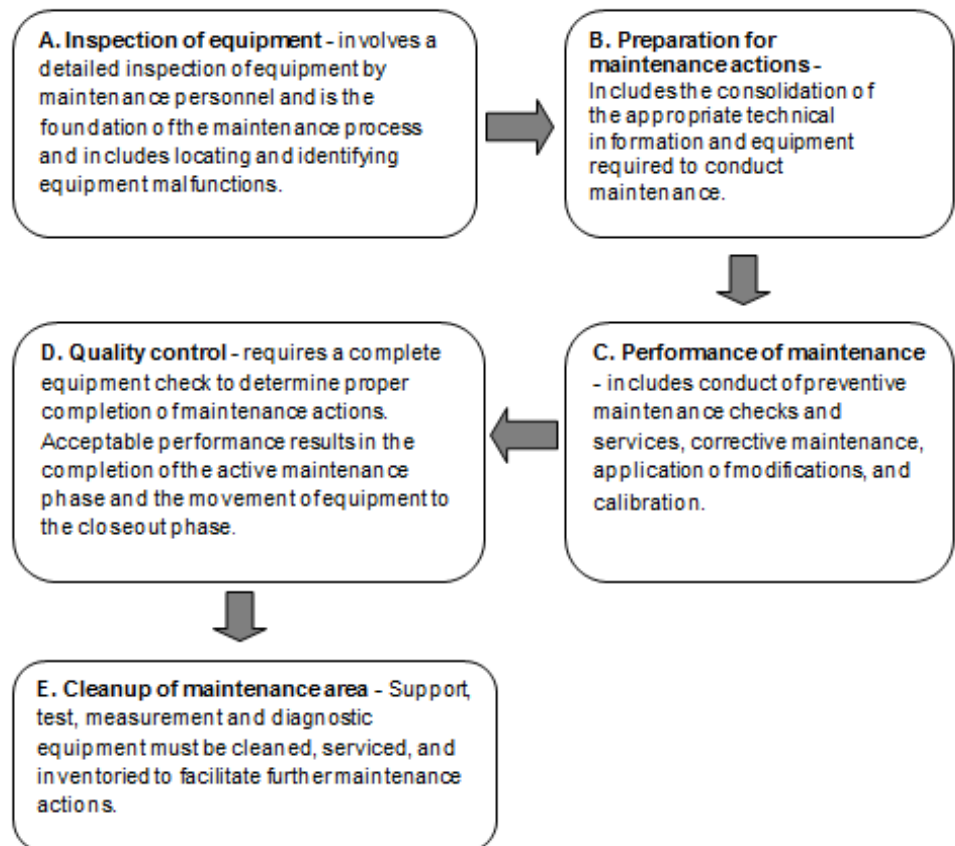

- Finally, the **maintenance closeout phase** commences when the equipment has been repaired and the serviceable item is returned to the owner or when a decision has been made to evacuate or dispose of the equipment.
- **Preventive maintenance checks and services** is a systematic program consisting of inspecting, cleaning, servicing, lubricating, and adjusting that is the key to maintaining equipment readiness because it helps prevent early breakdown or failure of equipment. An effective PMCS program also reduces the number of costly, complex and time-consuming repairs and allows the optimum use of maintenance resources through early detection of defects. The unit owning or using the equipment is responsible for scheduling and ensuring the completion of equipment PMCS.

Planning Considerations for Functions of Tactical Logistics (Continued)

Transportation

Transportation planning is throughput planning. It involves the determination of throughput requirements: *what, where, when, and how personnel and materiel must move to sustain the force.* Per MCW P 4-11, the transportation planner **sequences movement requirements in the following order:**

1. Determine the desired arrival time at destination (i.e., backwards planning).
 2. Select mode of transportation.
 3. Determine load and pickup points, intermediate and transfer points, as well as offload and drop points.
 4. Apply time/distance factors.
 5. Reconcile conflicting requirements for limited transportation assets (including MHE) and support facilities. Transportation planners will rarely, if ever, have sufficient resources to support all missions simultaneously.
 6. Test movement plan for feasibility.
- The following main elements must be considered when planning transportation:
 - Requirements list. This identifies what personnel, supplies, and equipment the planner must have.
 - Lift mode. The selected lift mode identifies what transportation means will move the personnel and cargo between origin point and destination. The transportation planner must be familiar with the capabilities and limitations of the various lift assets available.
 - Routing. Route selection will be governed by a number of planning factors, included but not limited to route security and trafficability for various transportation assets. For example – height restrictions for certain vehicle types on a main supply route (MSR) may mitigate against selecting a high-clearance vehicle for a transportation mission.
 - Timing. **Timely arrival of personnel, supplies, and equipment at the intended destination is the goal of transportation planning.** The key to transportation scheduling is flexibility. Basic limitations to timeliness include:
 - Required delivery date at location
 - Time when personnel, supplies and equipment are

Planning Considerations for Functions of Tactical Logistics (Continued)

Transportation (Continued)

- available for movement from their points of origin.
- Time/distance factors.
- Throughput capacities of support facilities.
- Capacity/security of staging bases and supply depots.
- Special requirements imposed by terrain, climate and environment.
- The transportation planner follows the listed steps when planning for transportation:

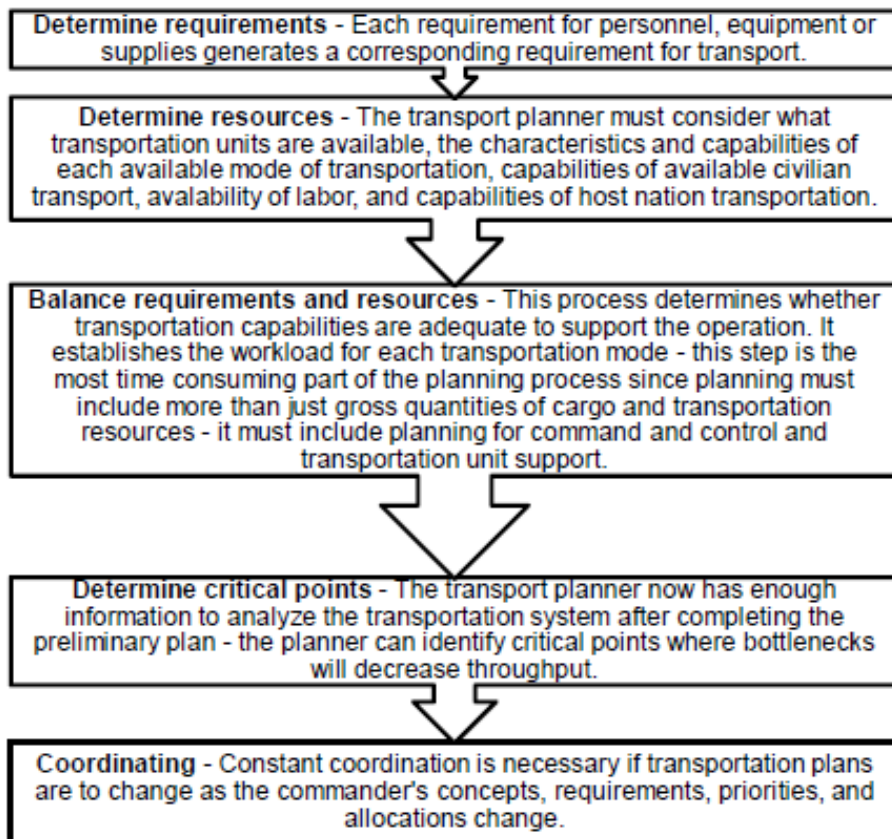

General Engineering

The following engineer support planning areas require special consideration:

- -Heavy equipment. Most heavy equipment cannot move quickly. Planners must consider how to rapidly move heavy equipment to where it can be best utilized. Heavy equipment also requires operators that have been trained on how to safely and effectively employ it.
- Transportation.
- Construction materials. Many CSS engineering tasks

Planning Considerations for Functions of Tactical Logistics (Continued)

General Engineering (Continued)

require large amounts of construction materials. The time, manpower, equipment and fuel required to assemble and use these supplies are often significant. Careful planning will minimize multiple handling during movement of these items to the construction site.

- Supply, maintenance, and ordnance support. Engineer units have many “low density” items of equipment requiring special maintenance to keep them operational. Low-density items range from mine detectors to types of pumps and generators to mobile construction equipment.
- Utilities support. Water purification, fuel distribution, and power generating equipment require significant motor transport, material handling equipment, manpower, and fuel in order to be properly employed. Space requirements are large, and camouflage is difficult. Utilities installations also generate large amounts of heat and noise.

Health Services

Capability will depend on where you are in the MAGTF. But think about whether:

- Enough medical equipment and supplies are present to support the force.
- Casualty tracking procedures are in place.
- You have a plan on how to move casualties out of the training area/area of operations.
- Higher echelon medical facilities are located and accessible.
- If needed, preventive medicine requirements and qualified preventive medicine technician-qualified corpsmen are available.
- Mass casualty procedures are established.
- Primary and secondary casualty receiving and treatment ships are ID'd for amphibious operations.
- Med requirements for specific areas – like malaria prophylactics, immunizations, etc, are sourced and distributed to personnel.

Services

Planning considerations for services vary for each particular service function and the operational situation. Following factors are common to all services functions:

- Responsibility
- Chain of command

Support Capabilities Across the MAGTF

- One of the important things to realize about how combat service support capabilities are distributed and integrated across the MAGTF is that each component of the MAGTF has its own internal, self-contained and “organic” support capabilities. All Marine units deploy as part of a MAGTF – they are not self-contained. We will review the overall MAGTF structure briefly and then proceed to examine in more detail the various CSS capabilities resident in each of its component parts.
- The Marine Air Ground Task Force (MAGTF) is the principal Marine Corps organization for all missions across the range of military operations. It is composed of forces task organized under a single commander capable of responding rapidly to a contingency anywhere in the world. The types of forces in the MAGTF are functionally grouped into four core elements: a command element (CE), an aviation combat element, (ACE), a ground combat element (GCE), and a logistics combat element (LCE). These core elements are categories of forces, not formal commands.
- The basic structure of the MAGTF never varies, though the size, number and type of Marine Corps units comprising each of its four elements will always be mission dependent. (MCWP 4-11 p. 2-3)
- The MAGTF is comprised of the following components:

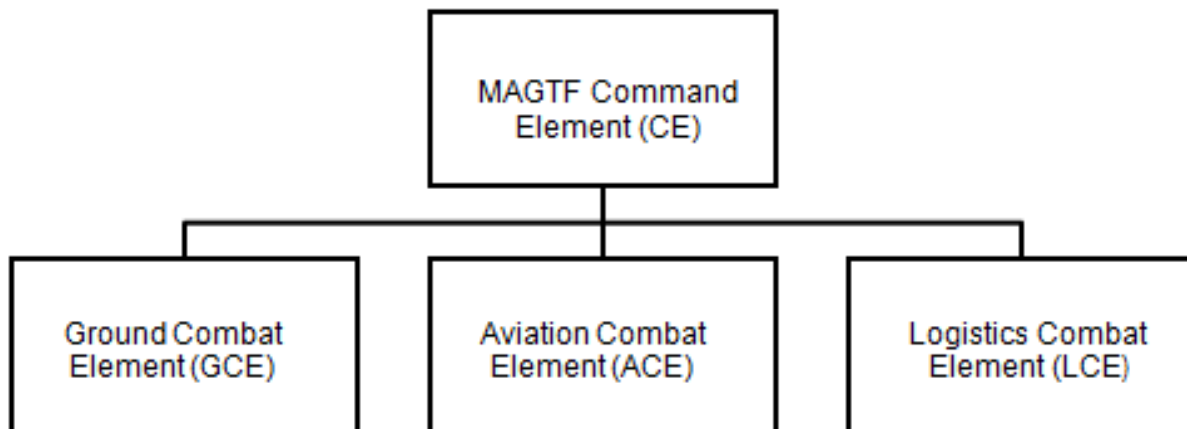

Support Capabilities Across the MAGTF (Continued)

Command Element The core element of a Marine air-ground task force (MAGTF) is the headquarters. The command element is composed of the commander, general or executive and special staff sections, headquarters section, and requisite communications support, intelligence, and reconnaissance forces, necessary to accomplish the MAGTF's mission. The command element provides command and control, intelligence, and other support essential for effective planning and execution of operations by the other elements of the MAGTF. The command element varies in size and composition; and, in a joint or multinational environment, it may contain other Service or multinational forces assigned or attached to the MAGTF. (MCRP 5-12C)

Ground Combat Element The core element of a Marine air-ground task force (MAGTF) that is task-organized to conduct ground operations. It is usually constructed around an infantry organization but can vary in size from a small ground unit of any type to one or more Marine divisions that can be independently maneuvered under the direction of the MAGTF commander. It includes appropriate ground combat and combat support forces, and in a joint or multinational environment, it may also contain other Service or multinational forces assigned or attached to the MAGTF. The ground combat element itself is not a formal command. (MCRP 5-12C)

Aviation Combat Element The core element of a MAGTF that is task-organized to conduct aviation operations. The aviation combat element (ACE) provides all or a portion of the six functions of Marine aviation necessary to accomplish the MAGTF's mission. These functions are anti-air warfare, offensive air support, assault support, electronic warfare, air reconnaissance, and control of aircraft and missiles. The ACE is usually composed of an aviation unit headquarters and various other aviation units or their detachments. It can vary in size from a small aviation detachment of specifically required aircraft to one or more Marine aircraft wings. In a joint or multinational environment, the ACE may contain other Service or multinational forces assigned or attached to the MAGTF. The ACE itself is not a formal command. (MCRP 5-12C)

Logistics Combat Element The core element of a Marine air-ground task force (MAGTF) that is task-organized to provide the combat service support necessary to accomplish the MAGTF's mission. The logistics combat element varies in size from a small detachment to one or more Marine logistics groups. It provides supply,

Support Capabilities Across the MAGTF (Continued)

Logistics Combat Element (Continued) maintenance, transportation, general engineering, health services, and a variety of other services to the MAGTF. In a joint or multinational environment, it may also contain other Service or multinational forces assigned or attached to the MAGTF. The logistics combat element itself is not a formal command.

The Marine Expeditionary Force (MEF) is the largest MAGTF and the principle Marine Corps warfighting organization – particularly for larger crises or contingencies. The MEF’s tactical logistics capabilities include the organic logistic personnel and equipment arrayed in the various units that comprise the MAGTF element and the CSS capabilities associated with the LCE. Let’s take a look at what organic support elements reside in each element of the MEF, taking First Marine Expeditionary Force (I MEF), headquartered in Camp Pendleton, California, as our case example:

I MEF Command Structure

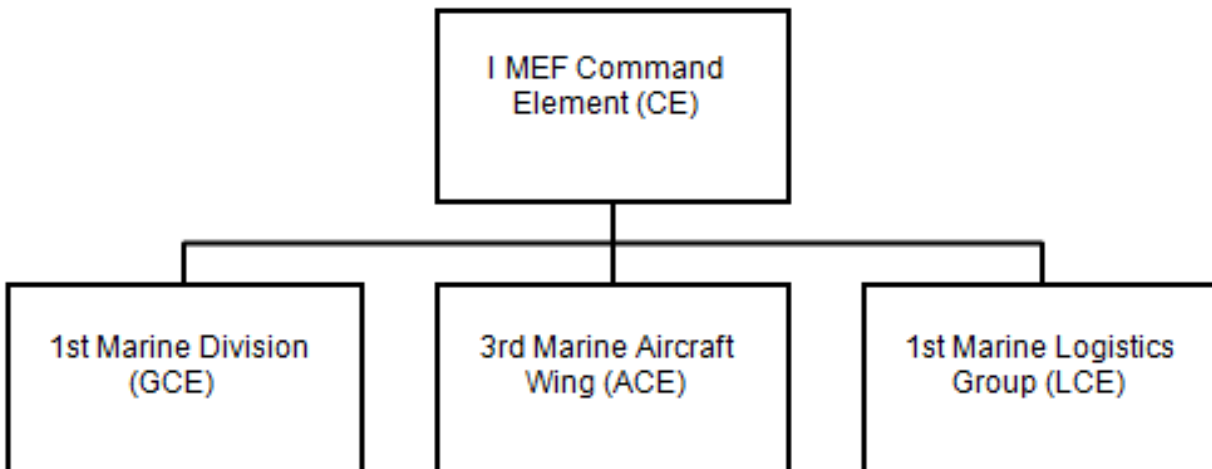

Marine Division CSS Capabilities

- Task organization for the 1st Marine Division – the “Blue Diamond” – headquartered in Camp Pendleton, CA, is as follows:

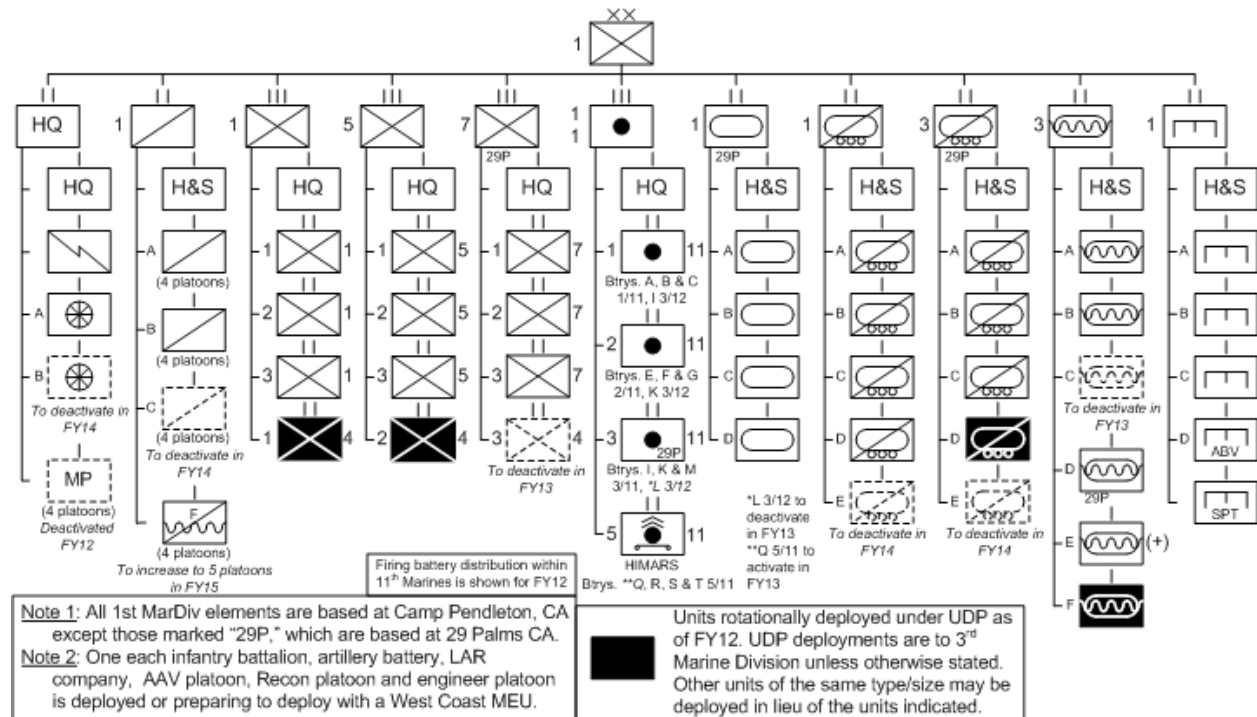

- The Marine Division does depend on the LCE for CSS – however, **the division is also structured with a significant array of robust, organic logistics capabilities which should be utilized before requesting outside support.**
- Organic CSS capabilities are located at the Division, Regimental, and Battalion levels and range from the two truck companies and Division G-4 staff section located under Headquarters Battalion to the Regimental and Battalion level S-4 staff sections. Typically, capabilities become less robust the further down the hierarchy in the Division – however, type and quantity of support required will always depend on mission requirements and available support. Infantry regiments and infantry battalion logistics sections – the “S-4” – are manned and equipped to support the mission of the GCE unit of which they are a part.
- LAR, CEB and artillery units have their own unique support requirements related to the specialized nature of their equipment and mission requirements. Think about all that has to go into supporting an artillery regiment during training and deployment. Motor transport requirements, ordnance and supply requirements, and maintenance considerations are all key to the success of the artillery fire support mission. The Assault Amphibian Battalion and Light Armored Reconnaissance Battalion is no exception to these as the logistical requirements associated with keeping the AAV and LAV in the fight are considerable.

Marine Division CSS Capabilities (Continued)

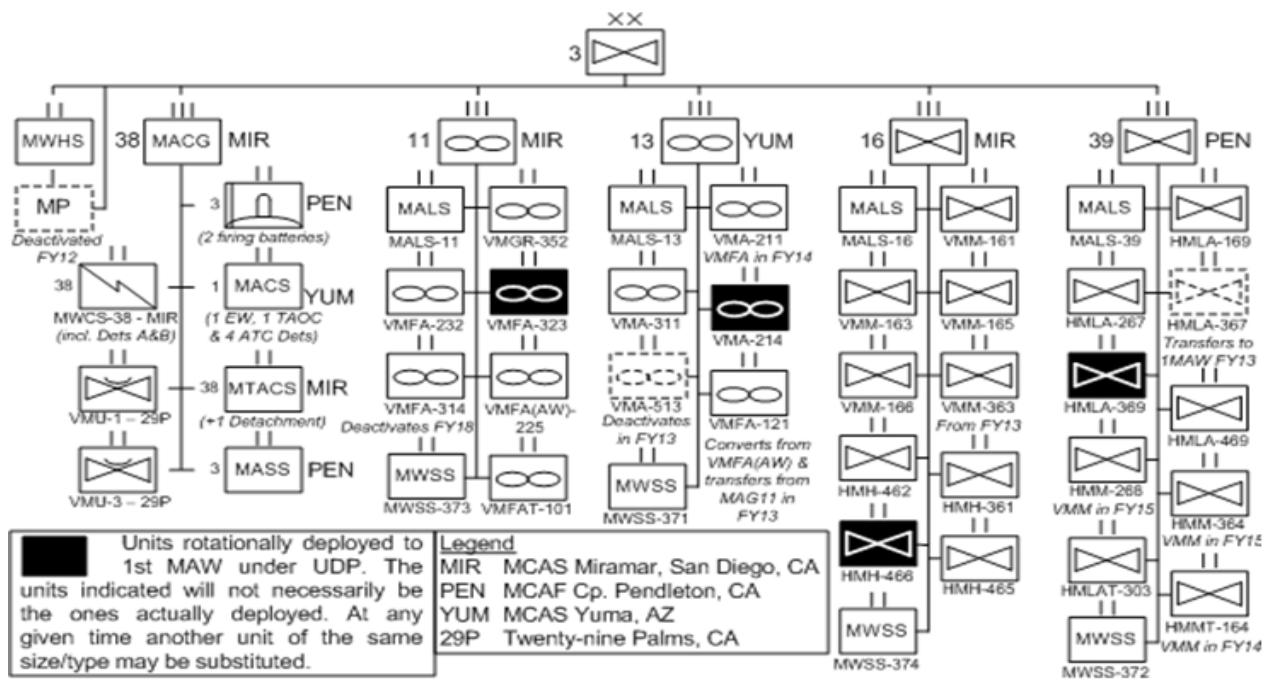

Marine Aircraft Wing CSS Capabilities

- The MAW possesses organic aviation and ground logistic capabilities. It employs organic aircraft- specific aviation supply, maintenance, and services capabilities in direct support of aircraft squadrons and groups. Although the MAW has its own aviation ground support capabilities, it depends on the LCE for ground CSS and delivery of aviation bulk commodities.
- The MAW is organized into a Marine wing headquarters squadron, fixed and rotary wing Marine aircraft groups, a Marine air control group, and a Marine wing support group. The two principle units in the MAW tasked to provide aviation-specific CSS beyond the capabilities of the various flying squadrons in the MAW are the Marine Aviation Logistics Squadron (MALS) and the Marine Wing Support Squadron (MWSS). The **Marine Wing Support Squadron (MWSS)** provides the following essential aviation ground support to the ACE:

- Internal airfield communications
- Weather services
- Expeditionary airfield services
- Aircraft rescue and firefighting
- Essential engineering services
- Motor transport support
- Field mess support
- Medical services
- Personnel training

Marine Aircraft Wing CSS Capabilities (Continued)

- Nuclear/biological/chemical defense
- Security
- Air base commandant functions
- Explosive Ordnance Disposal (EOD) support

- The **MALS** is another type of unit within the MAW that has a robust set of CSS capabilities. The MALS is primarily responsible for assisting flying squadrons with maintenance beyond the scope of the flying squadron's capability. The MALS also provide the following CSS capabilities:

Marine Logistics Group CSS Capabilities

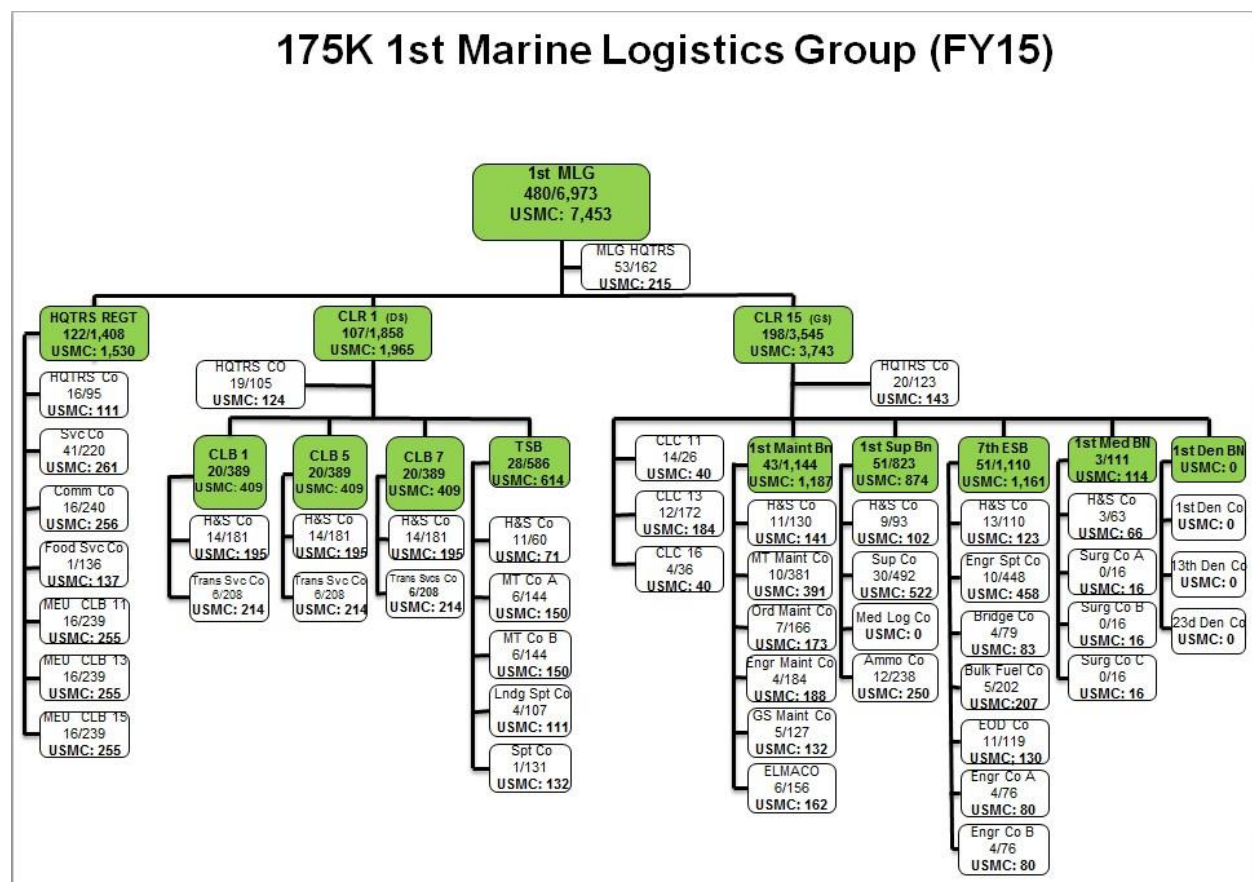

- The mission of 1st Marine Logistics Group (MLG) is to provide direct support to the Marine Expeditionary Force (MEF) Ground Combat Element (GCE) and general support and sustained tactical-level logistics support above the organic capabilities of supported elements of the MEF.
- The MLG is a permanently structured command that constitutes the Logistics Combat Element (LCE) of the MEF. When manned and equipped at full tables of organization and equipment (TO&E) levels, the MLG can support a MEF. The

Marine Logistics Group CSS Capabilities

MLG includes a headquarters for command and control, a direct support Combat Logistics Regiment (CLR), a general support CLR, an Engineer Support Battalion and a Dental Battalion that provide tactical logistics along functional lines. Like functions are generally centralized at the regiment or separate battalion level to facilitate command and control, coordination of tasking and training, and maintenance of equipment. Within the limits of their responsibilities, each regiment and separate battalion provides personnel and equipment to source task organized LCEs established to support Marine Air-Ground Task Forces (MAGTFs).

- MLG CLRs and subordinate Combat Logistics Battalions are distinguished by their support role and formal mission – they either have a **general support** mission or a **direct support** mission. Marine Corps doctrine states that:

“...formal missions dictate relationships, responsibilities, and C2 procedures. They facilitate planning for future operations by providing for on-order tasks. They also simplify the planning and execution of MAGTF operations.” (MCW P 4-11)

A CSS unit or organization with a direct support mission:

-Responds to CSS requests in priority from:

- 1) **Supported unit**
- 2) Higher CSS headquarters
- 3) Own units

-Provides liaison personnel to the supported unit

-Establishes communications with

- The supported unit
- Higher CSS headquarters

-Is positioned by the supported unit

Marine Logistics Group CSS Capabilities (Continued)

A CSS unit or organization with a general support mission:

-Responds to CSS requests in priority from:

- 1) Higher CSS headquarters
- 2) Supported units
- 3) Own units

-Establishes liaison with supported units

-Establishes communication with:

- Supported units
- Higher CSS headquarters

-Is positioned by higher CSS headquarters

(MCW P 4-11 p. 3-3)

Facilitating CSS in the Fleet Marine Force

- As previously discussed, you will be working with CSS planning considerations regardless of where you are assigned in the Fleet. Regardless of your MOS, being able to communicate in a common language and with common terminology and familiarity with procedures and processes related to the proper requisitioning of CSS will help you smoothly coordinate this no matter where you are in the request chain.
- We will use the CSS support relationships, support capabilities, and request processes typical of a Marine infantry battalion to illustrate key principles of the CSS planning, requisition and execution process.
- **Our doctrine provides us the following basic concepts that govern the planning of tactical logistics** – the kind of logistics we will be discussing as related to the infantry BN.
 - MCW P 4-11, Chapter 4, provides us the following **logistics planning concepts**:
 1. First off, *logistics planning should be concurrent with operations planning*. Simply put, **logisticians and operational planners need to conduct close, continual liaison and maintain strong lines of communication in order to be successful**. The operational planner who draws up a scheme of maneuver without soliciting input from his logistician counterpart will likely encounter

Facilitating CSS in the Fleet Marine Force (Continued)

significant friction as he attempts to execute his plan. Similarly, the logistician who develops a support plan without paying attention to the maneuver commander's intent and scheme of maneuver is in danger of violating the principles of logistics we previously discussed...principles like **responsiveness**, **economy**, **sustainability**, and **simplicity**.

2. Combat and combat support units should exploit their organic logistic capabilities before requesting assistance from combat service support sources. Simply put, this means every unit in the Marine Corps must make the best use of its own organic capabilities before requesting outside assistance. Remember the principle of **economy** as related to logistics planning? How economical would it be for a unit to let its own internal support capabilities remain idle while utilizing outside assistance?
3. The impetus of logistics is from the rear, directly to the using unit.
4. The logistic system must be responsive, effective and efficient.
 - Logisticians have developed detailed processes related to CSS planning in order to support units in the fight and in training. Just because these processes and procedures are located in logistics- centric reference publications does not mean that all Marines cannot draw something useful from them.
 - After consideration about planning factors related to the above functions of tactical logistics, your thought process will develop into a more structured and systematic way of approaching and attacking CSS related planning.

Facilitating CSS in the Fleet Marine Force (Continued)

Your thought process might look a little like the flow chart on the following page:



Now you can start to think about how to consolidate all this information into a way that is digestible and understandable to whoever is going to support you.

Facilitating CSS in the Fleet Marine Force (Continued)

The way this can be done is by utilizing a common template for logistical requisitions – commonly called a **Logistics Support Request (LSR) or Training Support Request (TSR)**. The below spreadsheet details what a sample LSR looks like. The function of this document is to streamline the request process from requesting unit to supporting unit.

EVENT:		LOCATION:						
DOD:		ETD:		TGT #				
DOR:		ETR:						
POC:		TEL:		UNIT:				
CHOW								
HOT		BOX						
NUMBER OF CHOWS PER DAY:		NUMBER OF CHOWS PER DAY:						
DATE AND TIME PICK UP:		DATE AND TIME PICK UP:						
COORDINATING INSTRUCTION		COORDINATING INSTRUCTION						
MRE		WET						
NUMBER OF CHOWS PER DAY:		NUMBER OF CHOWS PER DAY:						
DATE AND TIME PICK UP:		DATE AND TIME PICK UP:						
COORDINATING INSTRUCTION		COORDINATING INSTRUCTION						
MEDICAL								
NUMBER OF CORPSMAN REQUESTED:								
COORDINATING INSTRUCTION:								
EQUIPMENT REQUIRED:								
MOTOR TRANSPORTATION								
TYPE AND NUMBER OF VEHICLES:			DATE/TIME PICKUP:					
TYPE OF CARGO:			PICK UP LOCTATION:					
DRIVERS:			DATE/TIME OF RETURN:					
A DRIVER:			DELIVERY LOCATION:					
POC:								
COORDINATING INSTRUCTIONS:								
WATER BULL: YES NO N/A								
AMMO								
DODIC	NOMENCLATURE	QTY	DODIC	NOMENCLATURE	QTY	DODIC	NOMENCLATURE	QTY
A059	5.56MM BALL		B643	60MM HE M888		L495	SURFACE TRIP FLARE	
A063	5.56MM TRACER		B647	60MM ILLUM M721		L592	TOW BLAST SIM	
A064	5.56MM 4/1 LNKD		BA14	60MM WP M7222A1		L594	PROJECTILE SIM	
A075	5.56MM BLANK LNKD		C484	81M ILLUM INFRARED		L598	BOOBYTRAP FLSH SIM	
A080	5.56MM BLANK		C869	81MM HE M889/M889A1		L599	BOOBYTRAP ILLUM SIM	
A112	7.62MM BLANK		C870	81MM SMK RP M819		M023	1 1/4 LB C4 BLOCK	

Facilitating CSS in the Fleet Marine Force (Continued)

A131	7.62MM 4/1 LNKD		C871	81MM ILLUM M853		M028	BANALORE TORPEDO
A143	7.62MM BALL LNKD		G811	M69 PRACTICE GREN		M030	1/4 LB TNT BLOCK
A358	9MM PRACTICE AT-4		G878	PRACTICE GREN FUZE		M032	1 LB TNT BLOCK
A576	.50 CAL API/API-T LNKD		G881	M67 FRAGMENTATION GREN		M097	NON-ELEC DDI PRAC
A606	.50 CAL API MK 211-0		G945	YELLOW SMOKE GRENADE		M098	BLAST ELECT DDI
AA11	7.62MM LONG RANGE		G963	RIOT CS GRENADE		M130	ELECTRIC BLASTING CAP
AA12	9MM FX MARKING RED INK		G982	TRAINING SMOKE GRENADE		M131	NON-ELEC BLASTING CAP
AA21	9MM FX MARKING BLUE INK		HA21	21MM SUB-CALIBER		M456	DET CORD
AA53	5.56MM SPECIAL MATCH		HX05	83MM SMAW HE		M670	TIME FUZE
AX11	9MM SPOTTING RIFLE (S MAW)		HX07	83MM SMAW PRACTICE		M757	SATCHEL CHARGE
B519	40MM PRACTICE M781		J007	ANTI-PERSONNEL MINE		MN08	M81 FUSE IGNITOR
B535	40MM W HITE STAR PARA		J008	HG, SMK GRN M18 (MILES)		MN88	NON-ELEC BLAST 500 FT MINITUBE
B542	40MM HEPD LINKED (MK19)		K765	CS CAPSULE		W H03	TOW-2 SURF ATK
B546	40MM HEDP LOW VEL LCHD		L307	W HITE STAR CLUSTER		W H05	TOW-2 SURFACE PRACTICE
B642	60MM HE M720		L312	W HITE STAR PARA			

AMMO DRIVER:	RANGE:	
GUNNERS SIGNATURE:	DATE SUBMITTED:	
(DELIVERY) DATE:	TIME:	PRESTAGE DATE / TIME:
ARMORY		
SMALL ARMS TECH:		
DATES NEEDED:		
TIMES NEEDED:		
WEAPONS TYPES		
COORDINATING INSTRUCTION:		
PORT-O-JOHN		
DATE/TIME OF DROP OFF:		
DATE/TIME OF PICK UP:		
COORDINATING INSTURCTIONS:		

Facilitating CSS in the Fleet Marine Force (Continued)

REQUESTERS NAME		S4 REP NAME	
REQUESTERS SIGNATURE		S4 REP SIGNATURE	

Now that you have developed your support request and considered the functions of logistics and classes of supply, what now?

Your unit will almost certainly have some sort of organic CSS capability and a support relationship with higher and adjacent units.

- Since the construct we are using is the infantry battalion, you (or your platoon sergeant/company GySgt) would submit your request to the Battalion S-4. The Battalion S-4 is a staff section (hence the “S” designator) whose primary responsibility it is to support the CSS requirements of the command. *The below list details the task organization and capabilities of an infantry battalion S-4:*

 - (1) Captain, MOS 0402 Logistics Officer
 - (3) 1stLt/2ndLt, MOS 0402 Logistics Officer
 - (3) MOS 0411, Maintenance Management Specialist
 - (2) MOS 0431, Embarkation Specialist
 - (5) MOS 2111, Small Arms Repairer
 - (5) MOS 2171, Electro-Optical Repairer
 - (2) MOS 2311, Ammunition Technician
 - (10) MOS 3521, Motor Transport Mechanic
 - (11) MOS 3531, Motor Transport Operator
 - (1) MOS 3529, Motor Transport Maintenance Chief
 - (1) MOS 3537, Motor Transport Operations Chief
 - (9) MOS 3381, Field Mess Marine
- Now the logisticians have your request. It’s time for them to get into the stubby pencil work and support you. Let’s review how the support process works in the Marine Corps. In our example, the request for support has passed from the using unit to the supporting staff section within the infantry battalion. This dynamic – the support relationship that exists between your platoon and the logistics staff section – is present across the Marine Corps between various supporting units and agencies and the Marines in the fight they work to sustain.

Facilitating CSS in the Fleet Marine Force (Continued)

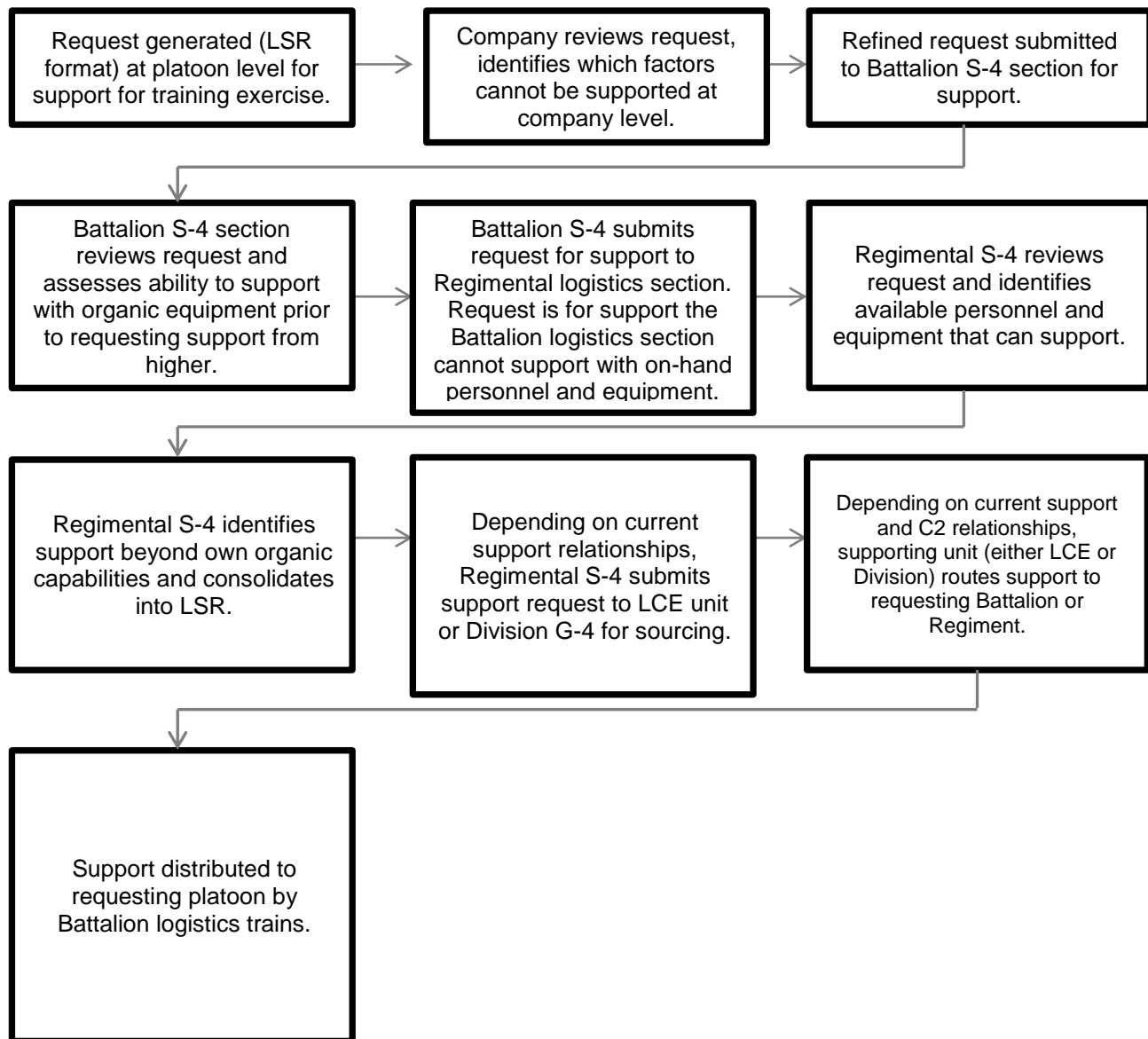

Utilizing Planning Factors and Determining Requirements

- Now that the S-4 has received your requirements, they will begin the detail intensive process of computing and sourcing your requirements. Logisticians utilize a number of processes and procedures to generate concrete numbers of requirements that you will need. This type of work occurs at a lot of different levels in the MAGTF. Let's review some of the detailed procedures utilized to develop robust Class 1 (Subsistence) and Class 3 (fuel) requirements.
- Logisticians speak frequently about the continuous process of gathering, refining, calculating, and adjusting planning factors and determining support requirements –

Utilizing Planning Factors and Determining Requirements (Continued)

requirements being the resources necessary to effectively support an operation. One process that can be used proceeds along the following lines:

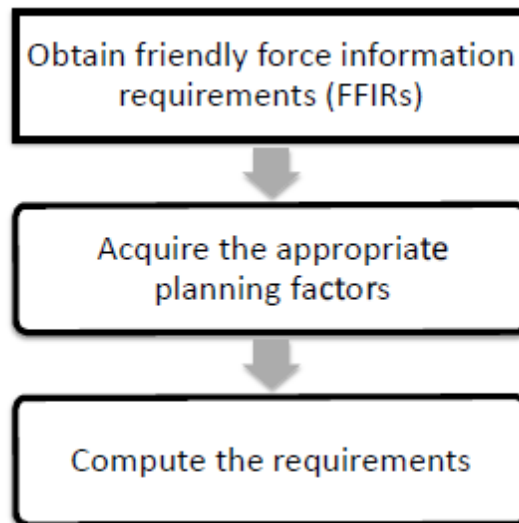

- **Planning factors** are measures of consumption or usage – how much a commodity (like water, fuel, ammunition, etc.) is used in a time period or how much an item of equipment is operated in a time period.
- **Usage data** is hard, verified information relating to consumption or hours of operation of a particular unit, in a specific environment.
- Assumptions are often required and can be a significant factor in planning.
- Planning factors break down into 2 types:
 1. **Standard**
 - Planning data and ratios obtained from official publications such as Marine Corps Orders, Marine Corps Warfighting Publications, Marine Corps Reference Publications, Technical Manuals, unit historical records, and validated After Action Reports
 2. **Nonstandard**
 - Come from expert opinion and non-validated data. This is where we start talking about the “art” of logistics...because do we really think the planning factors we research are **always** going to match the exact situation we are working with?

Utilizing Planning Factors and Determining Requirements (Continued)

Let's take a look at how to utilize several different ways to compute Class 1 (Subsistence) and Class 3 (Fuel) requirements.

Class 1 (Subsistence) computations for food consumption

Total requirement for each type of ration: $(P * D * M)/Ur = R$

P = unit strength

D = number of days

M = number of rations fed per day

Ur = number of rations per case

R = total number of cases of rations required

Class 1 (Subsistence) computations for water consumption

Formula used to determine water requirements: $P * D * R * 1.1 = W$

P = unit strength

D = number of days

R = consumption rate (gallons per day/event)

1.1 = 10% waste

W = total gallons of water required

Class 3 (Fuel) computations for gallon per hour fuel requirements

Formula used to determine **gallon-per-hour requirements**: $E * D * R * H = G$

E = Equipment Density

D = number of days the equipment will be operated

R = fuel consumption rate (gallons per hour) H = daily operational rate

G = total gallons of fuel required

Utilizing Planning Factors and Determining Requirements (Continued)

Class 3 (Fuel) computations for mile per gallon fuel requirements Formula used

to determine **mile per gallon factor**: $(D_i / M) * E * F = G$

D_i = Distance to be travelled

M = Miles per gallon

E = equipment density (number of pieces of equipment in the unit)

F = Frequency/number of times going to drive the distance

G = total gallons of fuel required

Sample Problems: Utilizing Planning Factors

Sample Problem 1:

You are responsible for calculating ration requirements to feed 2,945 personnel over 10 days. You are required to provide 3 MREs per day. You talk to your Field Mess Chief and you verify that each MRE case has 12 MREs. There are also 48 MRE cases per standard pallet.

Our planning factors are as follows:

$P = 2,945$ personnel

$D = 10$ days

$M = 3$ MRE's per day

$U_r = 12$ MRE's per case; 48 cases per pallet

Now, let's use the formula for calculating the requirement. $(P * D * M) / U_r = R$

$(2,945 * 10 * 3) / 12 = 7,362.5$ cases

Utilizing Planning Factors and Determining Requirements (Continued)

Sample Problem 2:

You are responsible for computing drinking water requirements for your unit that is comprised of 100 personnel who will be training in cold climate for 5 days.

Our planning factors are as follows:

P = 100 personnel

D = 5 days

R = cold climate water consumption rate. You can access this by reviewing MCW P 4-11.6, as detailed below. The per Marine consumption rate per day for arctic climate is 2.0 gallons per Marine per day.

Table 10-3. Water Requirements for Arctic Zones.

Company	Daily Gallons-Per-Man Requirements	
Function	Sustaining	Minimum
Drinking	2.0	2.0
Personal Hygiene	1.7	0.3
Field Feeding	1.3	0.8
Subtotal	7.5	3.1
+10% Waste	0.8	0.3
Total	8.3	3.4
Regimental Landing Team	Daily Gallons-Per-Man Requirements	
Function	Sustaining	Minimum
Drinking	2.0	2.0
Personal Hygiene	1.7	1.0
Field Feeding	2.8	0.8
Medical Treatment	0.4	0.4
Subtotal	6.9	4.2
+10% Waste	0.7	0.4
Total	7.6	4.6
Battalion	Daily Gallons-Per-Man Requirements	
Function	Sustaining	Minimum
Drinking	2.0	2.0
Personal Hygiene	1.7	1.0
Field Feeding	2.8	0.8
Subtotal	6.5	3.8
+10% Waste	0.7	0.4
Total	7.2	4.2
MEF	Daily Gallons-Per-Man Requirements	
Function	Sustaining	Minimum
Drinking	2.0	2.0
Personal Hygiene	1.7	1.0
Field Feeding	2.8	0.8
Level-1 Medical Treatment	0.4	0.4
Level-2 Medical Treatment	0.7	0.7
Subtotal	7.6	4.9
+10% Waste	0.8	0.5
Total	8.4	5.4

Formula for water requirement calculation =

$$P * D * R * 1.1 = W$$

$$100 * 5 * 2.0 * 1.1 = 1,100 \text{ gallons of water per day}$$

Utilizing Planning Factors and Determining Requirements (Continued)

Sample Problem #3:

You are responsible for calculating the fuel requirements for 50 HMMWVs that will be operating for 30 days. The vehicles will be on the road for 8 hours per day and will be driving 125 miles per day. Fuel consumption rate per vehicle is 6 gallons per hour. Mile per gallon planning factor is 10 MPG.

You can see where the information is available on the below excerpt from TM-11240-ODA, *Principal Technical Characteristics of US Marine Corps Motor Transport Equipment*.

TRUCK, UTILITY, EXPANDED CAPACITY, UP-ARMORED, ARMAMENT CARRIER, M1114 - CONT'D			
Performance Information			
Fording Depth		30 in (60 in w/kit)	
Highway Payload		2,300 lbs	
Cross Country Payload		2,300 lbs w/UAH	
Fuel Data			
Type of Fuel		Diesel/JF	
Fuel Tank Capacity		25 gal	
Fuel Consumption mpg		10 mpg	
Fuel Consumption per hour		6 gal/hr @ 60 mph	
Acquisition Information			
In Service Date		1 Apr 2004	
Service Life		15 yrs	
Planned Exit Date		1 Dec 2019	
Special Tool Kits			
TAMCN: D04752E	Tool Kit, 2D ECH, HMMWV	SL-3-09947A	NSN: 5180-01-216-8655
D04762E	Tool Kit, FM, 3D ECH, HMMWV		5180-01-198-7593
D04772E	Tool Kit, FM, 4 th ECH, HMMWV		5180-01-198-7594

Let us use the miles per gallon computation: $(Di / M) * E * F = G$

$(125 \text{ miles} / 10 \text{ MPG}) * 50 \text{ HMMWVs} * 30 \text{ days} = 18,750 \text{ gallons of fuel.}$

Consider this, though = the gallon per hour rate in the technical manual is based on a travel speed of 60 miles per hour. Is this realistic?

We have also not factored engine idle time into the equation. Will the vehicles shut off completely when halted?

Will our vehicles be carrying cargo? Would this pose an additional strain on the engine?

How steep is the terrain on which our vehicles will operate? Will rugged terrain increase our fuel consumption rate?

The point is that technical manuals cannot tell us everything. We need to rely on historical planning factors, our experience, the advice of the subject matter experts we work with...essentially, we need to work on our ability to practice the **art of logistics** and not reduce all problems to a simple computation.

Summary

Logistics is an integral and inseparable part of war. Our approach to logistics recognizes and accepts war as a complex, uncertain, disorderly, and time-competitive clash of wills and seeks to provide the commander with the physical means to win in this environment. We seek logistics capabilities that extend our operational limits, and that allow us to anticipate requirements while remaining flexible, adaptable, and responsive to the changing conditions in the battle space. You will deal with logistical considerations and combat service support planning in some way, shape or form out in the Fleet – utilize this handout and lesson as a starting point for generating and refining the detail-intensive planning needed to facilitate successful combat service support for your Marines.

References

<u>Reference Number</u>	<u>Reference Title</u>
MCDP 1	Warfighting
MCDP 4	Logistics
MCWP 4-1	Logistics Operations
MCWP 4-11	Tactical Level Logistics
MCWP 4-11.4	Maintenance Operations
MSTP Pamphlet 5-0.3	MAGTF Planner's Reference Manual, November 2012
MCRP 5-12C	Marine Corps Supplement to the Department of Defense Dictionary of Military and Associated Terms
MARADMIN 159/13	Levels of Maintenance
MCW P 4-11.6	Petroleum and Water Logistics Operations
TM-11240-ODA	Principal Technical Characteristics of US Marine Corps Motor Transport Equipment

Notes
