

---

**UNITED STATES MARINE CORPS**  
THE BASIC SCHOOL  
MARINE CORPS TRAINING COMMAND  
CAMP BARRETT, VIRGINIA 22134-5019

# **OPERATIONAL TERMS AND GRAPHICS STUDENT HANDOUT**

---

## **Operational Terms and Graphics**

---

### **Introduction**

In this lesson, you will be conducting self paced instruction (SPI) in order to familiarize yourself with Marine Corps operational terms and graphics. This lesson covers the fundamentals of military symbology. This programmed text is self-instructional. No attempt has been made to depict all operational symbols in this text; however, the symbols that you will study will provide you with techniques and uniform methods for graphically portraying various units, weapons, and activities. You will be allocated two hours to complete this self paced text.

---

### **Importance**

In order to fight, commanders and their staffs must issue orders to subordinates, which are directly tied to the commander's intent. These orders may be issued orally or in writing or by a combination of both. They may be issued in person or by electronic means. Words may be used as the principal means to communicate orders or sometimes only graphics are used to represent the intent of the commander. As a general rule, both are used; one complements the other. All Marines need a common language of operational terms and military symbols so that commander's intent can be communicated rapidly and with minimum risk of misunderstanding.

---

### **In This Lesson**

Some of the things to be discussed herein can give you the ability to communicate effectively in the Marine Corps. This text is not a test. It is designed to teach you individually and at your own pace.

---

**Operational Terms and Graphics (Continued)**

---

This lesson covers the following topics:

<b>Topic</b>	<b>Page</b>
Use of Operational Symbols	4
Questions on Use of Operational Symbols	5
Answers on Use of Operational Symbols	5
Marine Corps Divisions	6
Questions on Marine Corps Divisions	9
Answers on Marine Corps Divisions	10
Operational Symbols	11
Overlays	40
Tactical Control Measures	44
Tactical Tasks	56
Enemy Oriented Tactical Tasks	57
Terrain Oriented Tactical Tasks	61
Friendly Oriented Tactical Tasks	63
Fire Plan Overlay Symbols	65
Summary	69
Self-Test	70
Self Test Answer Key	74
References	78
Glossary of Terms and Acronyms	78
Notes	79

---

## **Use of Operational Symbols**

---

Leaders at all levels must be able to graphically depict units, weapons, and equipment by using doctrinally accepted military symbology. Knowledge and use of operational symbols provide the small unit leader with an effective medium of communications that is clear, concise, and uniform.

### **Description**

The term, operational symbol, refers to a diagram, number, letter, abbreviation, color, or any combination of these, which is used to identify and distinguish a particular military unit, activity, or installation. These symbols are used on operational graphics, situation maps, and overlays.

### **Keys to Symbol Use**

Operational symbols must be clear, concise, and uniform to be of value to the small unit leader in the field or the tactician in the planning room. Such value is attained by thorough knowledge and understanding of the organization of the Marine Corps. Knowledge of the organization of the Marine Corps is the key to construction and interpretation of military symbols.

---

### Questions on Use of Operational Symbols

---

**Question 1** As a means of communication, operational symbols are effective when properly employed because they are \_\_\_\_\_, \_\_\_\_\_, and \_\_\_\_\_.

**Question 2** Where are operational symbols used?  
\_\_\_\_\_, \_\_\_\_\_, and \_\_\_\_\_

**Question 3** What is the key to constructing and interpreting operational symbols?  
\_\_\_\_\_.

---

### Answers on Use of Operational Symbols

---

**Answer 1** As a means of communication, operational symbols are effective when properly employed because they are clear, concise, and uniform.

**Answer 2** Operational symbols are used on operational graphics, situation maps, and overlays.

**Answer 3** The key to constructing or interpreting operational symbols comes from the knowledge of the organization of the Marine Corps.

---

## Marine Corps Divisions

---

There are presently four divisions in the Marine Corps. Each division has three infantry regiments and one artillery regiment. You must know which regiments are in which division because a regiment is a parent unit.

### Divisions' Component Regiments

The table below lists the regiments that make up the four Marine Corps divisions.

Division	Component Regiments
1 <sup>st</sup> Marine Division	<ul style="list-style-type: none"> <li>• 1st, 5th, and 7th Marine Infantry Regiments</li> <li>• 11<sup>th</sup> Marine Artillery Regiment</li> </ul>
2d Marine Division	<ul style="list-style-type: none"> <li>• 2d, 6th, and 8th Marine Infantry Regiments</li> <li>• 10th Marine Artillery Regiment</li> </ul>
3d Marine Division	<ul style="list-style-type: none"> <li>• 3d and 4th Marine Infantry Regiments</li> <li>• 12th Marine Artillery Regiment</li> </ul>
4 <sup>th</sup> Marine Division	<ul style="list-style-type: none"> <li>• Is a reserve division</li> <li>• 23d, 24th, and 25th Marine Infantry Regiments</li> <li>• 14th Marine Artillery Regiment</li> </ul>

### Divisions' Component Regiments (Continued)

The composition of these divisions, except 3d Marine Division, is relatively stable. Thus, a Marine regiment need only be identified by its numerical designation, without mentioning the division designation or whether the regiment is infantry or artillery. For example, the 6th Regiment (infantry, 2d Marine Division) is simply called or written 6th Marines; the 11th Regiment (artillery, 1st Division) is simply called the 11th Marines, and so on.

The 4th Marines, headquartered in Camp Schwab, Okinawa, have only a permanent headquarters staff. The battalions rotate through on a six-month basis on the Unit Deployment Program (UDP).

---

## Marine Corps Divisions (Continued)

---

### Infantry Regiments

All infantry regiments are organized generally the same:

- Each has three infantry battalions: 1st, 2d, and 3d.
- Three rifle companies are in each infantry battalion, so each regiment has nine rifle companies.
- In addition to the rifle companies, each battalion has a Headquarters and Service Company (H&S Co) and a Weapons Company (Wpns Co)
  - o Companies A, B, and C are always in the 1st Battalion.
  - o Companies E, F, and G are always in the 2d Battalion.
  - o Companies I, K, and L are always in the 3d Battalion.

**Note:** Notice that the letter "J" is not used. (This avoids any confusion between "I" and "J").

- o Companies D, H, and M are contingency units, to be manned on special directive only.

### Infantry Battalions

Remember, infantry regiments are all organized identically, and each contains three battalions.

1 <sup>st</sup> Battalion	2d Battalion	3d Battalion
Companies	Companies	Companies
<ul style="list-style-type: none"> <li>• A</li> <li>• B</li> <li>• C</li> <li>• Wpns</li> <li>• H&amp;S</li> </ul>	<ul style="list-style-type: none"> <li>• E</li> <li>• F</li> <li>• G</li> <li>• Wpns</li> <li>• H&amp;S</li> </ul>	<ul style="list-style-type: none"> <li>• I</li> <li>• K</li> <li>• L</li> <li>• Wpns</li> <li>• H&amp;S</li> </ul>

## Marine Corps Divisions (Continued)

### Artillery Regiments

Both 10th and 11th Marines have four battalions within the regiment; 12th Marines has two battalions within the regiment. Each regiment also has a headquarters battery.

The 10th and 11th Marines are comprised of the following batteries:

- Batteries A, B, and C are found in 1st Battalion.
- Batteries E, F, and G are found in 2d Battalion.
- Batteries K, L, and I are found in 3d Battalion.
- Batteries R, S, and T are found in 5th Battalion.

12th Marines is comprised of the following batteries:

- Batteries A, B, and C are found in 1st Battalion.
- Batteries K, L, and I are found in 3d Battalion.

Each battalion also has a headquarters battery.

### Combat Support and Combat Service Support Units

In addition to the three infantry regiments and one artillery regiment in each Marine division, several support units are within each division (see diagram on page 9).

These support units take on the numerical designator of the division they support. That is, 2d Reconnaissance Battalion supports 2d Marine Division; 1st Tank Battalion supports 1st Marine Division, etc.

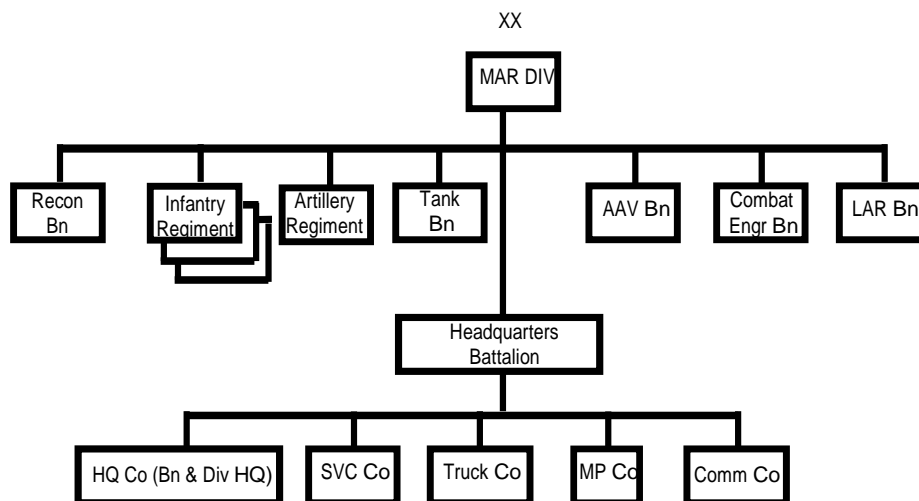

Combat Support and Combat Service Support Units



---

## Questions on Marine Corps Divisions

---

**Question 4**                      The 8th Marine Regiment is in the \_\_\_\_\_ Marine Division.

**Question 5**                      The artillery regiment in the 3d Marine Division is the  
\_\_\_\_\_.

**Question 6**                      Company "B" is always in the \_\_\_\_\_ Battalion.

**Question 7**                      The 3d Battalion, 7th Marines contains the following  
companies: \_\_\_\_\_, \_\_\_\_\_, \_\_\_\_\_, \_\_\_\_\_, and  
\_\_\_\_\_.

---

## Answers on Marine Corps Divisions

---

**Answer 4** The 8th Marine Regiment is in the 2d Marine Division.

**Answer 5** The artillery regiment in the 3d Marine Division is the 12th.

Remember

1st Marine Division	2d Marine Division	3d Marine Division
1st Marines	2d Marines	3d Marines
5th Marines	6th Marines	4th Marines: UDP battalions (one each from 3d Marines, 7th Marines, and 2d Marine Division) in six month rotations
7th Marines	8th Marines	
11th Marines (Arty.)	10th Marines (Arty.)	12th Marines (Arty.)

**Answer 6** Company "B" is always in the 1<sup>st</sup> Battalion.

**Answer 7** The 3d Battalion, 7th Marines contains the following companies: I, K, L, Weapons, and Headquarters and Service.

Remember: Infantry regiments are all organized identically and each contains three battalions.

1 <sup>st</sup> Battalion	2d Battalion	3d Battalion
Companies	Companies	Companies
<ul style="list-style-type: none"> <li>• A</li> <li>• B</li> <li>• C</li> <li>• Wpns</li> <li>• H&amp;S</li> </ul>	<ul style="list-style-type: none"> <li>• E</li> <li>• F</li> <li>• G</li> <li>• Wpns</li> <li>• H&amp;S</li> </ul>	<ul style="list-style-type: none"> <li>• I</li> <li>• K</li> <li>• L</li> <li>• Wpns</li> <li>• H&amp;S</li> </ul>

---

## Operational Symbols

---

### Definition

Operational symbols are graphic representations of units, equipment, installations, control measures, and other elements relevant to military operations. An operational symbol can be considered a form of military shorthand, which is used in the context of a map, such as a situation map, to describe the disposition of units on that map. Standardization of operational symbols is essential if operational information is to be passed among military units without misunderstanding.

### Units and Installations

---

Certain geometric figures are used as foundations for the construction of military symbols. The following figures are those used most frequently:

- A rectangle is used to represent units and command posts.



- For a command post, a staff is extended from the lower left corner of the rectangle, at a right angle to the base.

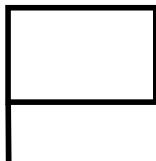

- An observation or listening post is depicted with a triangle.

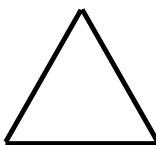

---

## Operational Symbols (Continued)

---

### Size Indicators

Now that you know the basic symbols for units, command posts, combat service support installations or activities, and observation or listening posts, you are ready to proceed to the next step, depicting size.

The table below shows symbols used to represent the size of a unit below company level:

Unit Size	Symbol
Squad	●
Section (larger than a squad, but normally smaller than a platoon. For example, a machine gun section contains 22 Marines.)	● ●
Platoon or detachment	● ● ●

**Note:** The symbol for a fire team is



This symbol will not be used in construction of unit symbols but will be used on overlays and fire plan sketches at the small unit level.

The table below shows symbols used to represent the size of units from company to regimental or group level:

Unit Size	Symbol
Company or battery	
Battalion (or squadron in aviation)	
Regiment (or group in aviation)	

## Operational Symbols (Continued)

### Size Indicators (Continued)

The symbols for brigade or higher-level units are Xs.

Unit Size	Symbol
Brigade (as task organized unit formed around a Marine regiment)	X
Division or wing	XX

### Questions on Units and Installations and Size Indicators

8. Dots are used to indicate the size of units below company level.

● Represents a \_\_\_\_\_.

● ● Represents a \_\_\_\_\_.

● ● ● Represents a \_\_\_\_\_.

9. Identify the size of the units depicted below.

Symbol	Identification
	_____ or _____
	_____ or _____
	_____ or _____
X	_____ or _____
XX	_____ or _____

---

**Operational Symbols (Continued)**

---

**Questions on Units and Installations and Size Indicators (Continued)**

10. The size of a particular unit is depicted with an operational symbol by placing the size indicator immediately above and centered on the unit symbol.

What do the symbols below represent?

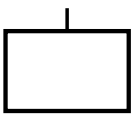
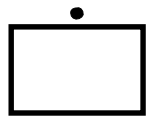
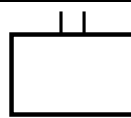
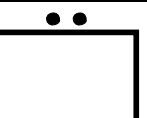
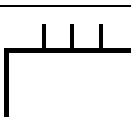
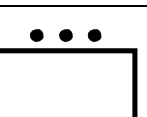
	_____		_____
	_____		_____
	_____		_____

**Answers on Units and Installations and Size Indicators**

8. Dots are used to indicate the size of units below company level.

- Represents a squad.
- ● Represents a section.
- ● ● Represents a platoon.



## Operational Symbols (Continued)

### Answers on Units and Installations and Size Indicators (Continued)

9. The size of the units depicted below are

Symbol	Identification
	<u>company</u> or <u>battery</u>
	<u>battalion</u> or <u>squadron in aviation</u>
	<u>regiment</u> or <u>group in aviation</u>
X	<u>brigade as task organized unit formed around a Marine regiment</u>
XX	<u>division</u> or <u>wing</u>

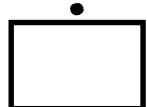
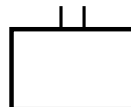
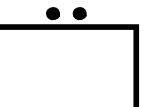
10. The symbols represent

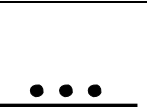
	<u>company</u>		<u>squad</u>
	<u>battalion/</u> <u>squadron</u>		<u>section</u>
	<u>regiment/</u> <u>group</u>		<u>platoon</u>

## Operational Symbols (Continued)

### Unit Symbol Modifiers









Unit symbol modifiers are combined with role indicators (discussed later in this text) to create composite symbols representing a unique or specific type of unit.

All modifiers, with the exception of airborne, mountain, and light modifiers, are placed in either the

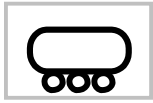
- Center of the frame.
- Upper half.
- Above the basic function symbol.

Airborne, mountain, and light modifiers are placed below the basic function/role indicator symbol.

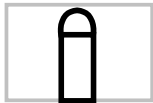

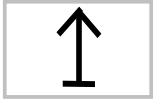







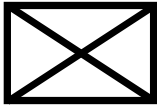

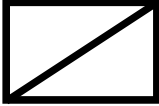
In addition to the modifier symbols, text may be used inside the symbol frame to further clarify the symbol. Examples:

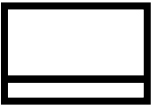
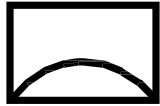
	Mechanized/ Armored (tracked)		Gun system equipped (w/30mm Bushmaster, Vulcan, ZSU, etc.)
	Mechanized/Armored (Wheeled, cross- country )		Motorized (truck or HMMWV mounted, etc.)
	Amphibious		Ski-mobile
	Missile		Riverine
	Air Assault (modifier for ground units)		Attack (modifier for aviation units)

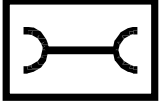

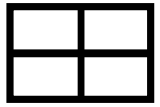
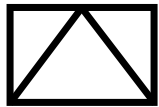
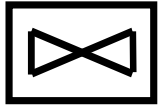
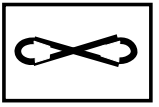



## Operational Symbols (Continued)

**Role Indicator Symbols** Role indicator symbols describe the basic role or mission of the unit. Combined with size indicators and any applicable unit symbol modifiers (discussed previously in this text), a detailed and informative symbol is created. The examples below include both the "raw" role indicators for common units and some combinations with unit symbol modifiers that describe units common in the Marine Corps (remember that these symbols describe unit roles, not individual pieces of equipment).

Infantry		Artillery	
Tank		Reconnaissance	
Engineer		Supply	
Air Defense		Communication	
Maintenance		Motor Transport	
Medical		Anti-Armor	
Helicopter Unit		Fixed-Wing Aviation Unit	
Mechanized Infantry		Assault Amphibian Vehicle Unit (AAV)	
Infantry Mechanized in AAVs		Light Armored Reconnaissance (LAR)	

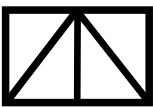

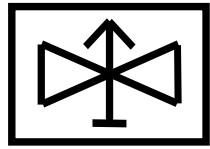
## Operational Symbols (Continued)

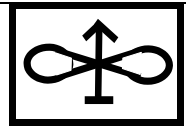
### Role Indicator Symbols (Continued)

Motorized Anti-Armor (CAAT)		Riverine Assault Craft Unit	
Motorized Stinger (Anti-Air) Unit		Attack Helicopter	
Air Assault Infantry		Fixed-Wing Attack Aviation	

### Marine Expeditionary Unit Symbols

The symbol with the appropriate size and unit designators depict Marine expeditionary units, which combine ground, aviation, and combat service support units.

<b>Marine Expeditionary Units</b>
Marine Air Ground Task Force (MAGTF) 
Marine Expeditionary Unit (MEU) 
Marine Expeditionary Force (MEF) 

**Questions on Size and Type of Unit**

11. What is the size and type of unit represented by each of the following symbols?

For example, the following symbol represents a rifle squad:

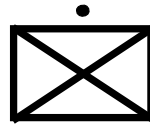

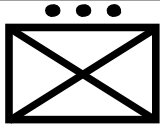
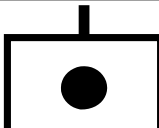
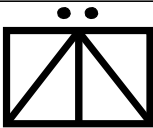
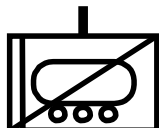
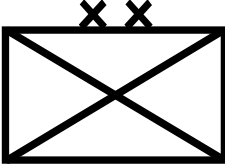
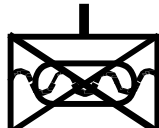
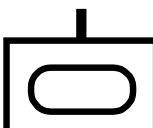
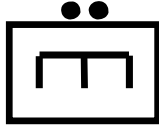
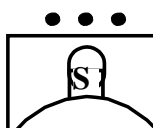
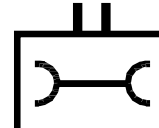
	_____		_____
	_____		_____
	_____		_____
	_____		_____
	_____		_____



---

**Operational Symbols (Continued)**

---

**Answers on Size and  
Type of Unit**

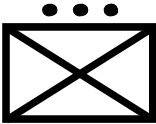
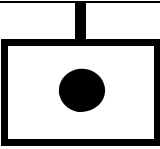
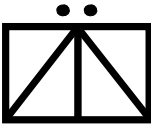
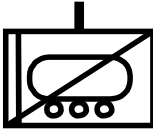
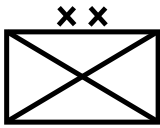
11. The size and type of unit represented by each of the following symbols are

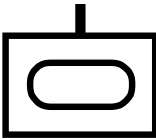
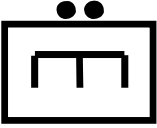
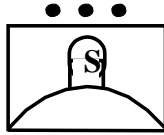
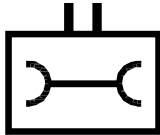
	Rifle platoon		Artillery battery
	Motorized anti-armor section		LAR company
	Marine division (all ground combat divisions in the Marine Corps are considered "infantry")		Rifle company mechanized in AAVs
	Tank company		Engineer section
	Stinger (anti-air missile) platoon		Maintenance battalion

## Operational Symbols (Continued)

### Reinforcements and Detachments

If a unit has other units or elements attached ("reinforced") or has detached some elements from itself ("reduced"), this is indicated to the upper right corner of the basic symbol with the following indicators:

- Reinforced (Rein): (+)
- Reduced (has units detached): (-)
- Reinforced and reduced ( $\pm$ )

For example:

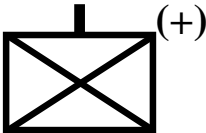
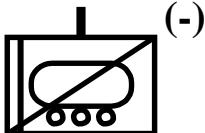
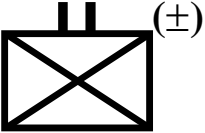
<b>Rifle Company (Rein)</b> 	<b>LAR Company (Reduced)</b> 	<b>Infantry Battalion (Rein) (Reduced)</b> 
--	--	---

### Task Force Indicator

If a unit is temporarily organized or "task-organized" for a specific operation, into a task force or company team, a "hood" is placed over the size indicator.

If a hood  is used, ( $\pm$ ) symbols are not used. For example:

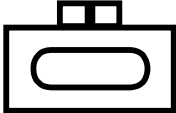
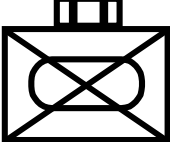
<b>Company Team:</b> Controlled by the tank commander 	<b>Battalion Task Force:</b> Commanded by the infantry battalion's command element 
---	--

**NOTE:** At a minimum, a battalion task force must include the battalion headquarters, one organic element, and one attached unit of comparable size of an unlike combat or combat support. An example would be an infantry battalion with at least its headquarters elements and one rifle company and one tank company.

---

## Operational Symbols (Continued)

---

### Task Force Indicator (Continued)

A company is referred to as a company team when it has one or more platoons of another combat arm attached. At a minimum, a company team must include either a rifle or tank company headquarters with at least one rifle or tank platoon attached.

### Questions on Reinforcements, Detachments, and Task Force Indicators

12. A unit that has been reinforced with elements of another unit has a \_\_\_\_\_ symbol at its upper right corner. A unit that has elements detached has a \_\_\_\_\_ symbol at its upper right corner.

13. A \_\_\_\_\_ is placed above the size indicator of a unit symbol to show that it is task-organized for a specific mission or operation.

14. Depict the following organizations:

Rifle Co (Rein)	Infantry Battalion (Rein) (minus HMGs)
Rifle Plt (Rein)	Rifle Co (Rein), in trucks
1 <sup>st</sup> Plt (Rein), Ski-mobile	Co-level MAGTF

## Operational Symbols (Continued)

### Answers on Reinforcements, Detachments, and Task Force Indicators

12. A unit that has been reinforced with elements of another unit has a **(+)** symbol at its upper right corner. A unit that has elements detached has a **(-)** symbol at its upper right corner.

13. A  is placed above the size indicator of a unit symbol to show that it is task-organized for a specific mission or operation.

14. The organizations should look like these:

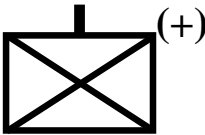
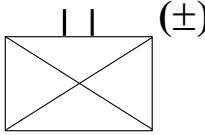
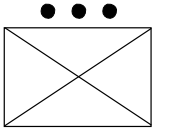
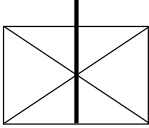
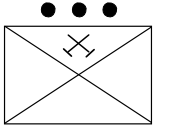
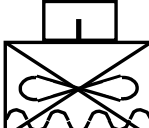



Rifle Co (Rein)		Infantry Battalion (Rein) (minus HMGs)	
Rifle Plt (Rein)		Rifle Co (Rein), in trucks	
1 <sup>st</sup> Plt (Rein), Ski-mobile		Co-level MAGTF	

## Operational Symbols (Continued)

### Creating Symbols

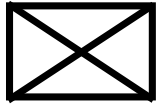
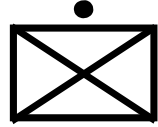
Now that we know how to construct the geometric form and indicate the size and type of unit, we must learn how to identify the specific unit by number and letter designator. This can be accomplished in a step-by-step procedure using all the information presented to this point, including our knowledge of the organization of the Marine Corps.

Let's draw the symbol for the 2d Squad, 1st Platoon, Company "C," 1st Battalion, 3d Marines, 3d Division:

Step	Action	Symbol
1	Begin with the basic symbol for a unit.	
2	Since it is an infantry unit, add the crossed rifles inside the basic symbol to identify the unit's role indicator.	
3	The size indicator for this unit is that of a squad, and is placed above the basic symbol.	
4	The squad to be designated is the 2d squad. This unique designation for the unit to be represented is placed to the immediate left of the basic symbol.	2 
5	The next higher unit of which the 2d squad is a component is the 1st platoon. The designation for the 1st platoon is placed to the immediate right of the basic symbol.	2 
6	The 1st platoon is part of company "C". Therefore, the designator for company "C" is placed to the right of the unit symbol after the 1st platoon designation.	2 
7	The next stop in the hierarchy of units is the regimental level. Since all infantry regiments have a first battalion and therefore a Company "C", the numerical designator of the regiment must be placed to the right of the symbol. Since this squad is part of 1st Platoon, Company "C", 1st Battalion, 3d Marines, then the number 3 will be placed to the immediate right of the last subordinate unit.	2 



---

## Operational Symbols (Continued)

---

### Creating Symbols (Continued)

NOTE: There is no need to indicate that company "C" is in the 1st Battalion since the organization of the Marine infantry regiment requires that the 1st Battalion be composed of Companies "A," "B," and "C"; Wpns Company; and HqSvc Company.

The symbol is now complete. There is no need to indicate that the 3d Marines are in the 3d Marine Division. Remember that the infantry and artillery regiments are permanently assigned to certain divisions. The 3d Marines are always organic to the 3d Marine Division along with the 4th, 9th, and 12th (Arty) Marines.

Remember that the unit is identified from the smallest subunit to the parent organization omitting those designators that are unnecessary or redundant.

The symbol contains the following elements:

Size Indicator

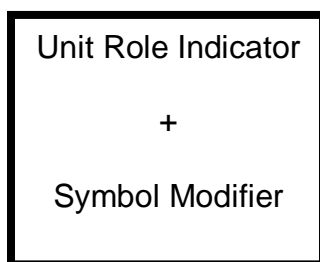



Unique Unit Designation

Higher Echelon Unit Designation

**Operational Symbols (Continued)**

Questions on Creating Symbols

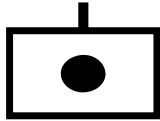

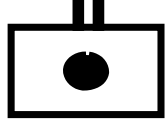
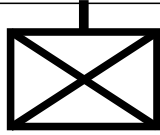

15. What are the complete written designators of the following units?

<p>1  2/C/7</p> <p>_____</p>	<p>B  11</p> <p>_____</p>
<p>3  G/1</p> <p>_____</p>	<p>3  12</p> <p>_____</p>
<p>G  6</p> <p>_____</p>	

## Operational Symbols (Continued)

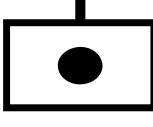
### Answers on Creating Symbols

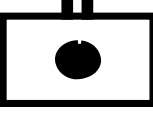
15. The complete written designators are

<p>1  2/C/7</p>	<p><u>1st Sqd, 2d Plt,</u> <u>Company C, 1st Bn,</u> <u>7th Mar, 1st</u> <u>MARDIV</u></p>	<p>B  11</p>	<p><u>Battery B, 1st Bn,</u> <u>11th Mar, 1st</u> <u>MARDIV</u></p>
<p>3  G/1</p>	<p><u>3d Plt, Company G,</u> <u>2d Bn, 1st Mar, 1st</u> <u>MARDIV</u></p>	<p>3  12</p>	<p><u>3d Bn, 12th Mar, 3d</u> <u>MARDIV</u></p>
<p>G  6</p>		<p><u>Company G, 2d Bn,</u> <u>6th Mar, 2d</u> <u>MARDIV</u></p>	

### Enemy Units

Enemy units and equipment are denoted as diamonds; for example:

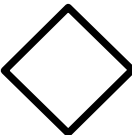
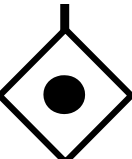
Basic Enemy Unit	
Enemy Artillery Battery	

### Enemy Units Questions

Construct the unit symbols for the following units:

Enemy Rifle Squad
Enemy Rifle Company

---

**Operational Symbols (Continued)**

---

**Enemy Units Answers**

Enemy units should look like these

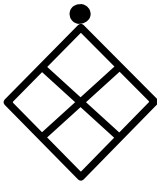
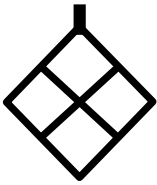
Enemy Rifle Squad	
Enemy Rifle Company	

**Basic Weapon Symbols**

Symbols are used to indicate the

- Type
- Location
- Number

of weapons or groups of weapons.

**NOTE:** Unlike unit symbols, weapons symbols are oriented on a map or overlay in the same direction they are actually oriented on the ground, with the base of the symbol shaft indicating the location of the weapon.

To indicate the size of the weapon, add horizontal bars to the shaft of the basic weapon symbol:



Basic weapon symbol (light)	Basic weapon symbol (medium)	Basic weapon symbol (heavy)
—	=	≡

---

**Operational Symbols (Continued)**

---







**Basic Weapon Symbols** For example:  
(Continued)

<p>Light rifle/automatic weapon</p> 	<p>Medium rifle/automatic weapon</p> 	<p>Heavy rifle/automatic weapon</p> 
---	--	---

Many other modifiers are used in conjunction with the basic weapon symbol (above) and size indicators to indicate the weapon's

- Role
- Capabilities
- Functions





For example:

<p>Antitank</p> 	<p>Rocket</p> 	<p>Indirect fire/high trajectory</p> 
<p>Direct fire gun</p> 	<p>Anti-air/air defense</p> 	<p>Surface-to-surface missile</p> 

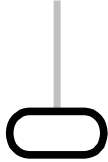

## Operational Symbols (Continued)

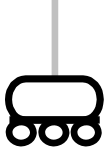
### Mobility Modifiers

Additional modifiers are added to weapon or equipment symbols to annotate its mobility capabilities. These are generally placed at the bottom of the equipment symbol.

Track self-propelled 	Wheeled (limited cross-country) 	Wheeled (cross-country) 
Wheeled (cross-country), armor-protected 	Amphibious 	Over-snow 

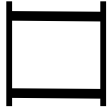

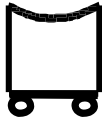
The following types of equipment have their own unique symbol:

Tank 	Infantry fighting vehicle 	Limited cross-country cargo/personnel carrier (e.g. 5-ton; HMMWV) 
---	--	--

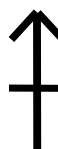

## Operational Symbols (Continued)

**Type/Caliber Modifiers** To reduce confusion or to clarify the meaning of a given symbol, it is sometimes necessary to specify, to the immediate left of the weapon symbol, the weapon





- Types or models (such as M249).
- Calibers (.50 cal)

M249 squad automatic weapon (SAW)		M2 .50 cal machine gun							
M249		OR	SAW		M2		OR	.50	

- Quantity. The quantities of weapons or pieces of equipment at a given location are enumerated at the top of the symbol.

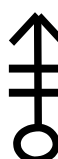
Three M249 SAWs	Two M240G machine guns
3 SAW 	2 7.62 

The following symbols identify weapon systems common to the Marine Corps.

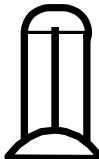







60mm mortar 	81mm mortar 	120mm mortar 
AT-4 84mm antitank rocket 84 	83mm SMAW 83 	Stinger anti-air missile 

---

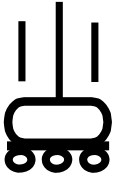
**Operational Symbols (Continued)**

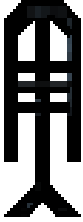
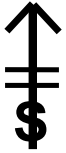
---

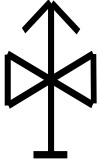
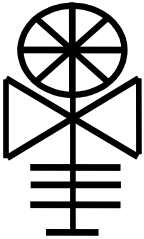

**Type/Caliber Modifiers  
(Continued)**

M203 grenade launcher 	Mk-19 grenade launcher 	LAV-25 
Javelin Anti-Tank Missile 	TOW antitank missile 	M40A1 7.62mm sniper rifle 
SASR .50 cal sniper rifle 	105mm howitzer 	155mm howitzer 
Fixed-wing attack aircraft 	Attack helicopter (Cobra) 	Heavy-lift assault helicopter (CH-53) 

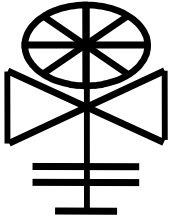

## Operational Symbols (Continued)

### Type/Caliber Modifiers (Continued)

<p>Medium-lift assault helicopter (CH-46)</p> 	<p>Assault amphibious vehicle (AAV)</p> 	<p>M1A1 tank (the three vertical lines identify this as a "heavy" tank)</p> 
---	---	---

### Unit Identification Labeling Fields

If it is necessary to identify the unit to which a given weapon belongs, the weapon symbol is labeled similar to a unit symbol. The unit to be represented is placed at the bottom left of the basic symbol, and the higher unit information is placed at the bottom right of the basic symbol.

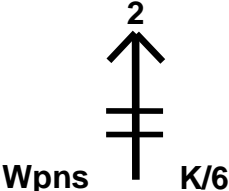
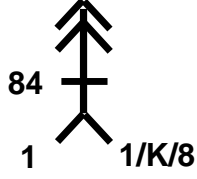
<p>Two M240G machine guns belonging to Weapons Plt, Kilo Co, 3d Bn, 6th Mar</p> 	<p>One AT-4 rocket belonging to 1st Sqd, 1st Plt, Kilo Co, 3d Bn, 8th Mar</p> 
---	---

## Operational Symbols (Continued)

### Unit Identification Labeling Fields (Continued)

The following graphic provides general, overall guidance on the construction of an entire weapon system complete with typically used labeling fields. Other labeling fields can be found in MIL-STD-2525D, Joint Military Symbolology.

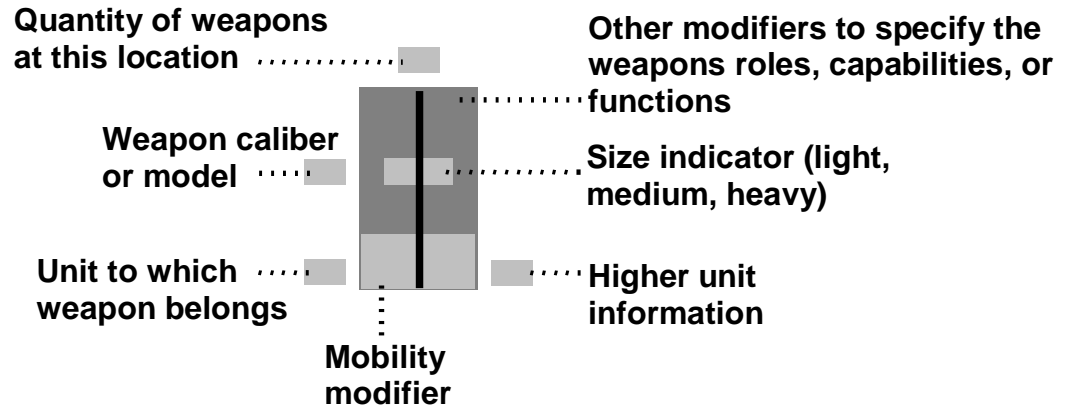

### Questions on Enemy, Weapons, and Unit Identification Field Symbols









16. Draw the symbol for each of the following descriptions.

Cobra attack helicopter	Medium machine gun	M203 grenade launcher
TOW anti-tank missile mounted on a limited cross-country vehicle	Three AAVs	Two 155mm howitzers of Battery C, 1st Bn, 10th Mar
Stinger-variant of the LAV from 2d LAR Bn	Six SMAWs from Wpns Plt, B Co, 1st Bn 8th Mar	Two TOW missiles mounted on HMMWVs, from Wpns Co, 1st Bn, 5th Mar
	Four 81mm mortars from 2d Bn, 6th Mar	

## Operational Symbols (Continued)

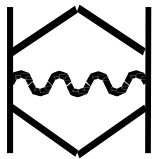
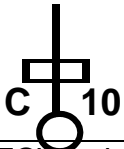
### Answers on Enemy, Weapons, and Unit Identification Field Symbols

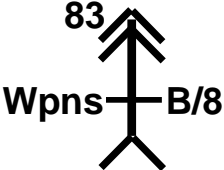

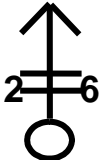



16. The symbols for the following descriptions are

<p>Cobra attack helicopter</p> 	<p>Medium machine gun</p> 	<p>M203 grenade launcher</p> 
<p>TOW anti-tank missile mounted on a limited cross-country vehicle</p> 	<p>Three AAVs</p> <p>3</p> 	<p>Two 155mm howitzers of Battery C, 1st Bn, 10th Mar</p> <p>2</p> 
<p>Stinger-variant of the LAV from 2d LAR Bn</p> 	<p>Six SMAWs from Wpns Plt, B Co, 1st Bn 8th Mar</p> <p>6</p> 	<p>Two TOW missiles mounted on HMMWVs, from Wpns Co, 1st Bn, 5th Mar</p> <p>2</p> 
	<p>Four 81mm mortars from 2d Bn, 6th Mar</p> <p>4</p> 	

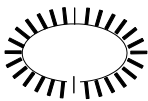
## Operational Symbols (Continued)

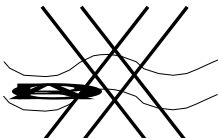



### Mobility and Survivability Symbols

The following mobility and survivability symbols are frequently used on situation maps and are for the most part self-explanatory.

<b>Strong point</b> 	<b>Antitank ditch (top of triangles is toward enemy)</b> 	<b>Fortified line</b> 
<b>Roadblock, completed</b> 	<b>Unspecified wire obstacle</b> 	<b>Singe strand concertina</b> 
<b>Antitank minefield</b> 		<b>Booby trap</b> 

### Mobility and Survivability Questions

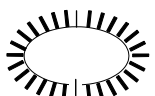
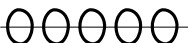
17. What are the complete written descriptions of the following mobility and survivability symbols?

a. _____ 	b. _____ 
c. _____ 	d. _____ 
e. _____ 	f. _____ 





---

**Operational Symbols (Continued)**

---

**Mobility and Survivability Answers**

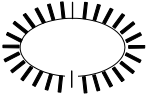
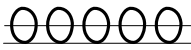
17. The complete written descriptions of the mobility and survivability symbols are

<p>a. <u>Antipersonnel minefield</u></p> 	<p>b. <u>Unspecified wire obstacle</u></p> 
<p>c. <u>Strongpoint</u></p> 	<p>d. <u>Double-strand concertina wire</u></p> 
<p>e. <u>Booby trap</u></p> 	<p>f. <u>Antitank ditch</u></p> 

**Colors**

A situation map is a map upon which the tactical intelligence and/or logistical situation is represented graphically. Colors are sometimes used on situation maps to allow them to be read more quickly and easily. The following colors are standard:

- Blue for friendly units and/or equipment.
- Red for enemy units and/or equipment (diamond shape or “ENY” if only one color is used).
- Yellow for unknown or pending identification.
- Green for neutral forces and all obstacles whether friendly, enemy, or neutral.
- Black for all friendly control measures; used as the single color for all graphics if colors above are not available.

**Color Question**

18. What color is used to describe each of the following on a situation map:

- a. Friendly units: \_\_\_\_\_
- b. Neutral forces: \_\_\_\_\_
- c. Enemy obstacles: \_\_\_\_\_
- d. Enemy units: \_\_\_\_\_

---

**Operational Symbols (Continued)**

---

**Color Answer**

18. What color is used to describe each of the following on a situation map:

- a. Friendly units: blue
- b. Neutral forces: green
- c. Enemy obstacles: green and identified with "ENY" markings
- d. Enemy units: red or identified with "ENY" markings

**Determining Unit and Equipment Location**

A unit's location is either at "center mass" of the symbol or is identified by a straight or bent line (without an arrow) leading to its exact location. A headquarters unit's location is either at the end of its staff or at the end of its bent staff.

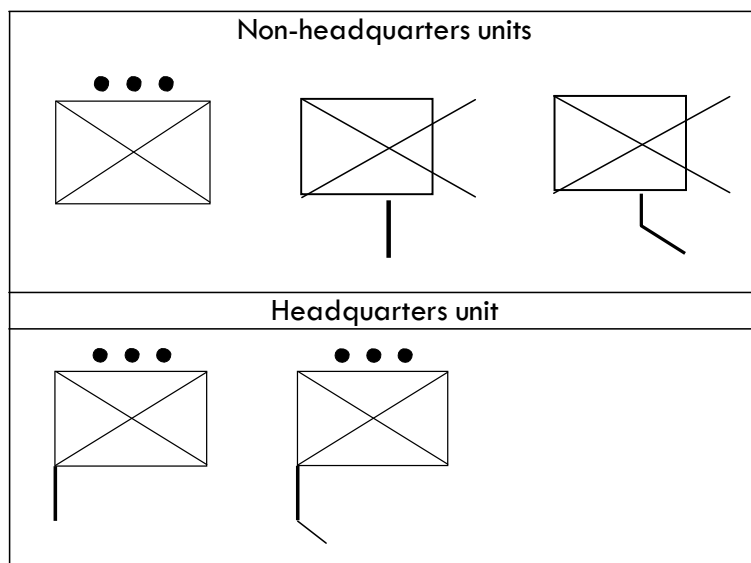

A future or projected location for a unit is identified using a broken/dashed line:

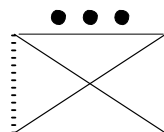

---

**Operational Symbols (Continued)**



---

Below is an example of groups of units or headquarters units at the same location:

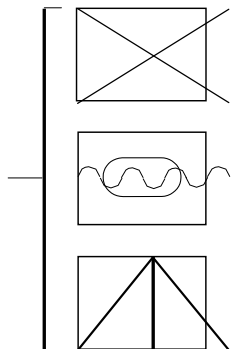
Groups of non-headquarters units

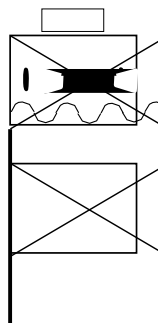

Groups of headquarters units

**Unit and Equipment  
Location Question**

---

19. A unit's present location is identified either from its \_\_\_\_\_ or by a \_\_\_\_\_ extending from the bottom center of the unit symbol. A broken line around the symbol identifies a unit's \_\_\_\_\_ or \_\_\_\_\_ location. A unit's present location is identified either from its center mass or by a line extending from the bottom center of the unit symbol. A broken line around the symbol identifies a unit's future or projected location

---

## Overlays

---

An overlay is a transparent or translucent medium upon which special military information has been plotted at the same scale of a map, photograph, or other graphic. An overlay can be used to make changes in unit

- Positions.
- Weapons.
- Movements.

### Using Overlays

First an overlay must be oriented to the map. Register marks are drawn to align with grid square corner and are labeled. New details or changes in the map are then plotted on the overly. Finally, marginal information is added. Marginal information includes:

- Title
- Time and date of information
- Map reference to include
  - Sheet name
  - Sheet number
  - Map series number
  - Scale
- Prepared by, to include
  - Name and rank
  - Organization
- Date and time of preparation
- Legend
- Classification

The classification is also placed on the top and bottom of the overlay. A legend must only be added when nonstandard symbols are used.



---

**Overlays (Continued)**

---

**Overlay Question**

20. What is the marginal information that must be included on an overlay?

- \_\_\_\_\_
- \_\_\_\_\_
- \_\_\_\_\_
- \_\_\_\_\_
- \_\_\_\_\_
- \_\_\_\_\_
- \_\_\_\_\_
- \_\_\_\_\_
- \_\_\_\_\_
- \_\_\_\_\_
- \_\_\_\_\_
- \_\_\_\_\_
- \_\_\_\_\_

A \_\_\_\_\_ must only be added when nonstandard symbols are used.

---

**Overlays (Continued)**

---

**Overlay Answer**

20. Marginal information that must be included on an overlay is

- Title
- Time and date of information
- Map reference to include
  - Sheet name
  - Sheet number
  - Map series number
  - Scale
- Prepared by, to include
  - Name and rank
  - Organization
  - Date and time of preparation
- Legend
- Classification

A legend must only be added when nonstandard symbols are used.

## Overlays (Continued)

### Overlay Example

The following is an example of an overlay. Note the labeled grid register marks and the locations of the enemy strongpoint, rifle platoon, and rifle company CP.

If this were an actual overlay, it would be on transparent or translucent paper.

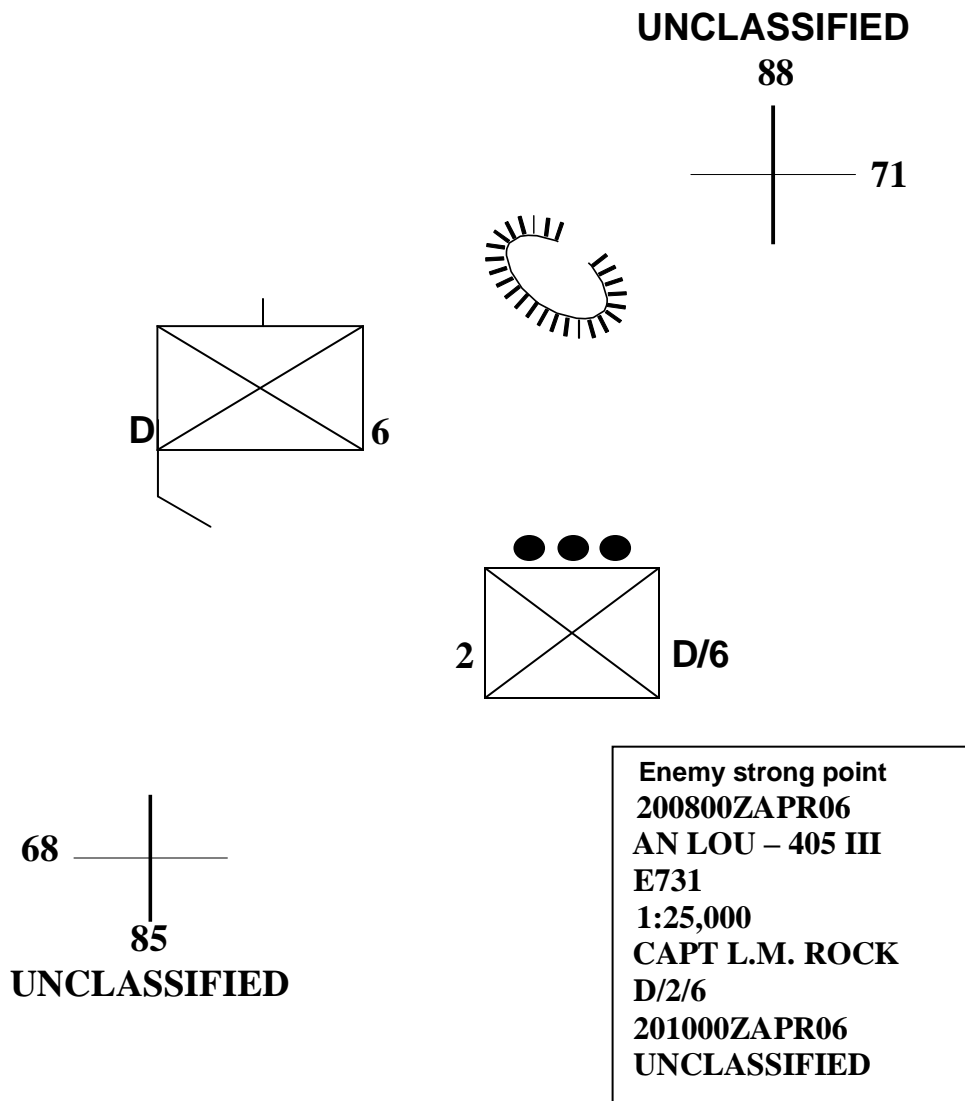

## Tactical Control Measures

This portion of the text will discuss the techniques and graphic portrayal of control measures. They are used to

- Coordinate
- Limit
- Define
- Direct

a unit's movement or responsibilities.

### Assembly Area

An assembly area is the area where a unit assembles to prepare for further action. Assembly areas are enclosed with a solid line and the unit symbol is placed inside the circle. The CP symbol may be used if the CP location is known. A future or proposed assembly area is shown with a broken line. For example, here is the representation for an assembly area occupied by 2d Bn, 9th Marines:

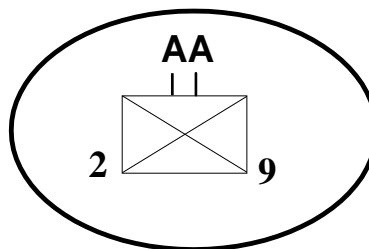

### Assault Position

This is the last covered and concealed position short of the objective and is occupied by elements to allow final coordination and to deploy in the final attack formation. A unit designation, number, or code name may be used for identification.

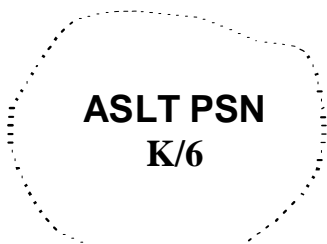
<p>Assault position: Co K, 3d Bn, 6th Mar</p> 	<p>Assault position: Co K, 3d Bn, 6th Mar (planned)</p> 
---	--

## Tactical Control Measures (Continued)

### Objectives

An objective is usually a key terrain feature, area, or an enemy force, which is to be seized or engaged in an attack. Objectives are enclosed with a solid line and identified by the abbreviation "OBJ" and number, letter, code name or unit designation. Examples are

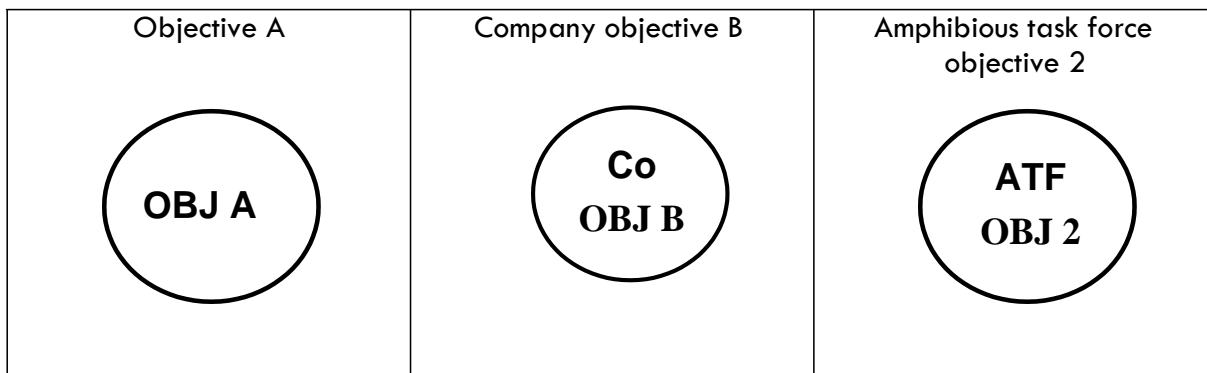

**NOTE:** When numbers are used to identify objectives, the numbers do not necessarily establish importance, priority, or sequence of seizing objectives.

### Battle Position

A battle position (BP) is a defensive location normally established relative to an avenue of approach or enemy route of advance. Battle positions are enclosed by a solid black line broken by a unit size symbol on the side of the blocking position opposite the enemy or suspected enemy advance. Examples are

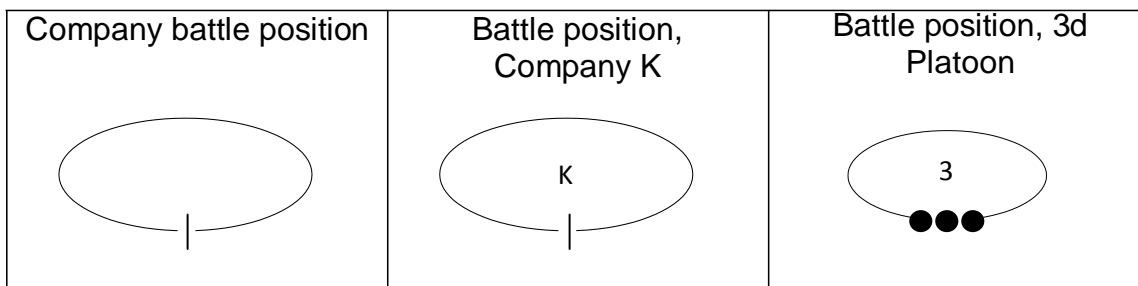

---

**Tactical Control Measures (Continued)**

---

**Tactical Control  
Measures Questions**

21. Depict below the proper symbols for Battalion Landing Team Objective One and Lime Company's battle position defending against an enemy advancing from the bottom of the page.

Battalion Landing Team Objective One	Battle position, Company L
--------------------------------------	----------------------------

22. Using Co A, 1st Bn, 4th Mar and Company Objective B as a tactical control measure, graphically portray and correctly label the following control measures

Assembly area	Assault position	Objective
---------------	------------------	-----------

---

**Tactical Control Measures (Continued)**



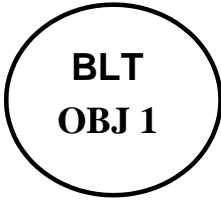
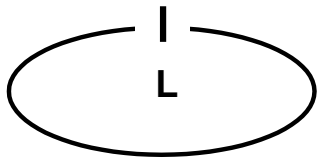

---

**Tactical Control Measures Answers**

21. The proper symbols for Battalion Landing Team Objective One and Lime Company's battle position defending against an enemy advancing from the bottom of the page are

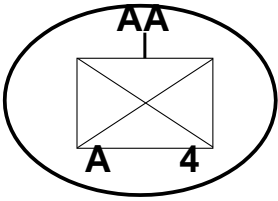
<p>Battalion landing team objective one</p> 	<p>Battle position, Company L</p> 
---	--

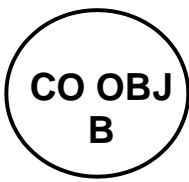
22. Using Co A, 1st Bn, 4th Mar and Company Objective B as a tactical control measure, the graphic portrayal and correctly label of the control measures are

<p>Assembly area</p> 	<p>Assault position</p> 	<p>Objective</p> 
--	--	---

**Miscellaneous Areas**

In addition to the symbols you have seen represented with a *solid closed line*, miscellaneous areas are also *enclosed with a line*. These areas are identified by the *purpose* placed within the symbol. For example,

**Landing zone (LZ)**

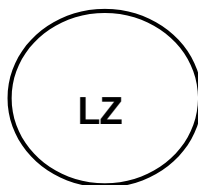

**LZ Crow**

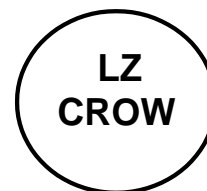

---

## Tactical Control Measures (Continued)

---

### Abbreviations

Abbreviations are frequently used with military symbols on maps and overlays. Only standard abbreviations may be used. When there are no authorized standard abbreviations, the word is spelled out. In either case, only capital letters are used and all words and abbreviations are horizontal with the map oriented north to the top. The only exceptions to the horizontal labeling rule are when labeling a route or axis of advance, which are labeled along the longitudinal axis.

Notations are made on operation maps and overlays to be read from left to right with the map oriented north to the top, regardless of the position or direction of movement of friendly forces.

---

### Boundaries

Boundaries control the maneuver and fire of adjacent units and establish

- Zones of action in the offense
- Sectors of responsibility in the defense

Boundaries are normally drawn along easily recognizable terrain features and are situated so key terrain features and avenues of approach are inclusive to one unit. For example, the boundary separating 1st Marine Division from 2d Marines would look like this:

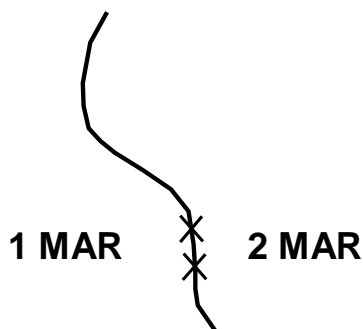

**NOTE:** The size symbol of the larger unit is always indicated on the boundary. Any supplemental information to clarify the arm, branch, or national designation of the units involved may be included.



---

**Tactical Control Measures (Continued)**

---

**Line of Departure**

A line designated to coordinate the departure of attacking elements. The LD should be generally perpendicular to the direction of the attack and on easily identifiable terrain features. The time of attack should be written below the LD.

*LD***200630RJUL06***LD***200630RJUL06****Axis of Advance**

The axis of advance indicates a general direction of movement for a unit. A commander assigned an axis of advance may deviate from the axis; however, a major deviation must be reported. It is labeled with a code name, letter, or unit designation.

**Airborne Axis of Advance**

The airborne axis of advance is the same as a ground axis of advance except it has a twist in the shaft of the open arrow.

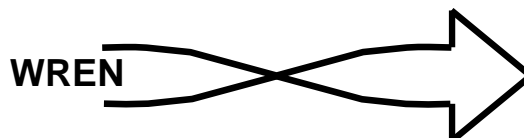

---

## Tactical Control Measures (Continued)

---

### Direction of Attack

The direction of attack is a *specific direction* that the *center of mass* of a unit must follow. It is the most restrictive measure and is not labeled. This example also includes a PD, or *point of departure*, which is the exact point through which a unit will cross the line of departure (usually for night operations), and an RP, or *release point*, where one or more units will break off from the rest and continue on a different route to the objective. A line with a double arrowhead is the *main effort* or main attack, and a line with a single arrowhead is a *supporting effort*.

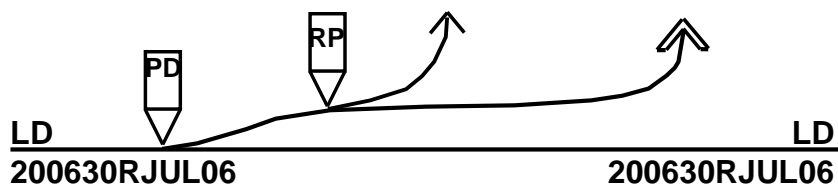

### Checkpoint

A checkpoint is an easily identifiable location on the map and on the ground designated as a reference point for reporting the locations of friendly units. A checkpoint is depicted with the symbol shown and a number, letter, or code name placed inside the symbol. *For security, random numbering of checkpoints is essential.*



### Passage Point

A passage point is a location in which one unit passes through another unit that is in contact with the enemy or a location where a unit withdraws through another unit occupying rearward positions. It will be labeled with a number or letter for identification.



---

**Tactical Control Measures (Continued)**



---

**Linkup Point**

A linkup point is a point at which two converging friendly forces make physical contact. The point should be mutually agreed upon and should be readily recognizable by both forces.

**Contact Point**

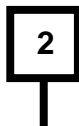
A contact point is a location where two or more units are *required* to make *physical contact*. It is a square with a number placed inside.

**Phase Line**

A phase line is used for the control of forward movement and coordination of units. It should be extended across the entire zone or sector, preferably along an easily identifiable terrain feature or man-made object. It is labeled with a code name, letter, or number for identification.

**PL GREEN**

**PL GREEN**

**Coordinating Point**

A coordinating point is a designated point at which, in all types of combat, adjacent units/formations must make contact for purposes of control and coordination.



---

## Tactical Control Measures (Continued)

---

### Coordinating Point (Continued)

Coordinating points are placed at the intersection of the forward edge of the battle area (FEBA) and any lateral boundaries. Additionally, coordinating points may be used where phase lines are used to control security forces forward of the FEBA. When possible, coordinating points should be located on readily identifiable terrain that the commander wants subordinate commanders to coordinate observation and fires in a defensive situation. The subordinate commanders determine at these points whether the area between their units should be covered by

- Fires.
- Barriers.
- Physical occupation.
- A combination of these means.

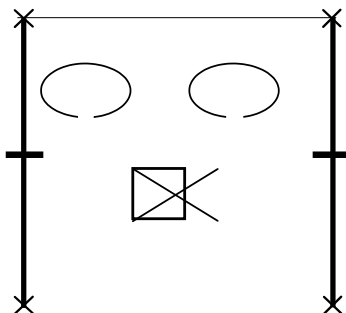

### Restrictive Fire Line (RFL)

A restrictive fire line is a line established between converging friendly forces (one or both may be moving) that prohibits fires or the effect of fires across the line without coordination with the affected force.

~~RFL 6<sup>TH</sup> MAR  
200630RJUL06~~

~~RFL 6<sup>TH</sup> MAR  
200630RJUL06~~

### Coordinated Fire Line (CFL)

A coordinated fire line is a line beyond which conventional surface fire support means (mortars, artillery, naval gunfire) may fire at any time within the zone of the establishing headquarters without additional coordination.

~~CFL 6<sup>TH</sup> MAR  
200630RJUL06~~

~~CFL 6<sup>TH</sup> MAR  
200630RJUL06~~

---

## Tactical Control Measures (Continued)

---

### Fire Support Coordination Line (FSCL)

A fire support coordination line is a line the senior ground unit commander prescribes forward of which air elements may attack targets without danger or references to the ground forces. Behind this line, all fires must be closely coordinated with the ground unit commander.

~~FSCL 6<sup>TH</sup> MAR 200630RJUL06~~                      ~~FSCL 6<sup>TH</sup> MAR 200630RJUL06~~

### Final Coordination Line (FCL)

A final coordination line is a line close to the enemy position used to coordinate the lifting and shifting of supporting fires with the final deployment of maneuver elements.

~~FCL 6<sup>TH</sup> MAR 200630RJUL06~~                      ~~FCL 6<sup>TH</sup> MAR 200630RJUL06~~

### Zone of Action

A zone of action is a tactical subdivision of a larger area, the responsibility of which is assigned to a tactical unit, generally applied to offensive combat. Zones of action assigned to subordinate units prevent interference among units operating in adjacent areas. At platoon and squad levels, the zone of action is frequently expressed as a frontage. At company level and above, zone of action is normally defined by a line of departure, an objective (or objectives), and a boundary on one or both flanks. A battalion zone of action is shown graphically as:

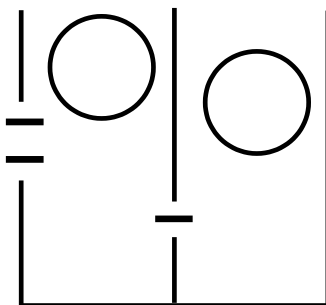

The example on the next page portrays a zone of action for the 6th Marines conducting a combination helicopter borne and surface assault. PL GREEN and the “proposed” boundaries give the 2d Battalion CO the means to control the forward rate of advance of his companies and provides inherent flexibility in changing the plan should circumstance beyond PHASE LINE GREEN warrant.

**Tactical Control Measures (Continued)**

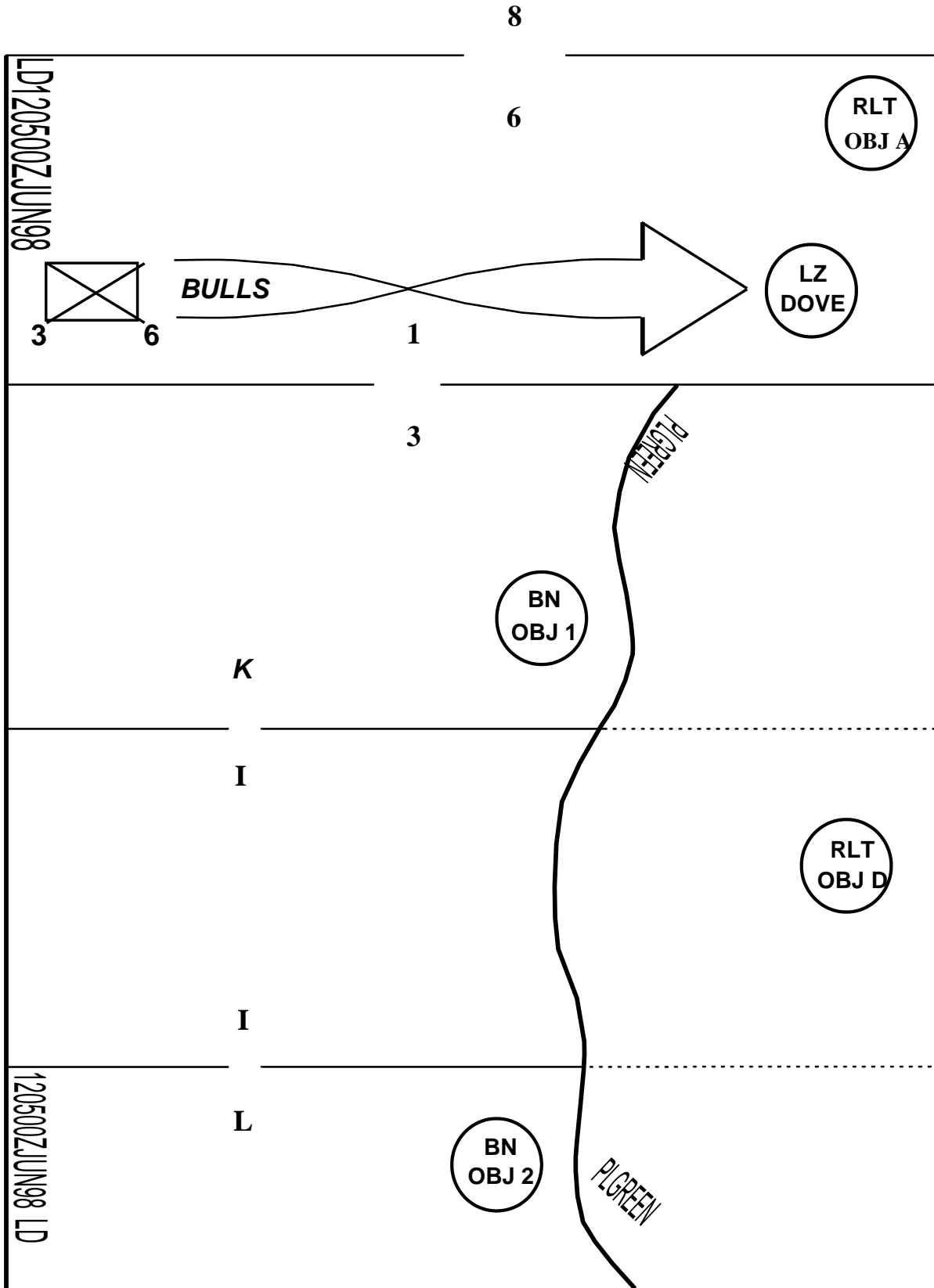

## Tactical Control Measures (Continued)

### Defensive Sector

The defensive sector is that defensive area, designated by boundaries, within which a unit operates and for which it is responsible. It is the defensive equivalent of the zone of action used in offensive operations. In general, the same restrictions apply to boundaries in the defensive operations as apply in offensive operations; one commander is responsible for the coordination of all fires and maneuver employed inside the boundaries.

The commander to whom the sector is assigned is not required to occupy the entire battle area. The battle area is defined as that area organized for defense by a single forward committed unit and extends rearward from the FEBA to the unit's rear boundary or to the rearward extension of the lateral boundaries. That portion of the defensive sector which is forward of the FEBA is called the *security area*. A commander to whom a defensive sector is assigned is responsible for maintaining security forces within his *security area*. A battalion defensive sector is shown graphically:

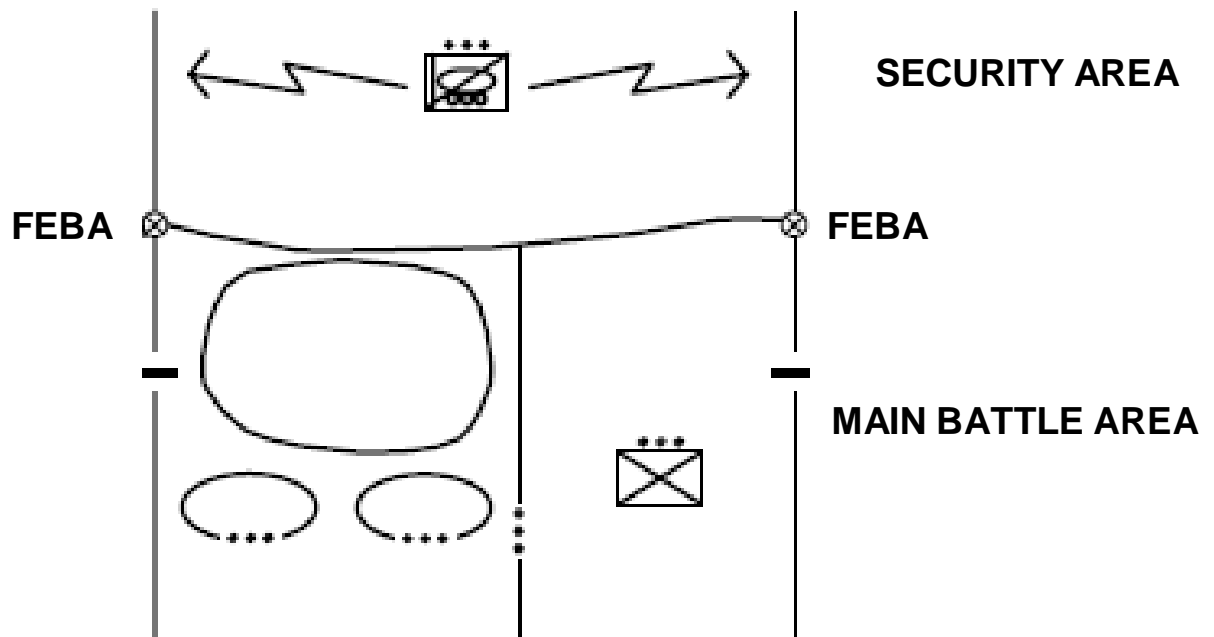

**NOTE:** FM 101-5-1 (MIL-STD-2525D) and OH 6-1 contain additional tactical control measures and military symbols. Those publications should be used as the standard reference documents for graphic portrayal of military units and activities.

---

## Tactical Tasks

---

**Definition**

A tactical task is the specific activity performed by a unit while executing a form of tactical operation or form of maneuver. It may be expressed as enemy-, terrain-, or friendly-oriented tasks. Tactical tasks describe the results or effects the commander wants to achieve: the what and why of a mission statement. The following is a list of commonly used tactical mission tasks; this list is not all-inclusive.

<b>Enemy-Oriented Tactical Tasks</b>	<b>Terrain-Oriented Tactical Tasks</b>	<b>Friendly-Oriented Tactical Tasks</b>
Ambush	Clear	Breach
Attack by Fire	Control	Cover
Block	Occupy	Disengage
Breach	Reconnoiter	Displace
Bypass	Retain	Exfiltrate
Canalize	Secure	Follow and Assume
Contain	Seize	Follow and Support
Destroy		Guard
Disrupt		Protect
Exploit		Screen
Feint		
Fix		
Interdict		
Neutralize		
Penetrate		
Reconnoiter		
Rupture		
Support by Fire		
Suppress		



---

**Enemy-Oriented Tactical Tasks**

---

**Ambush**

A surprise attack by fire from concealed positions on a moving or temporarily halted enemy.

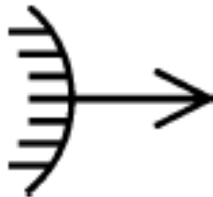
**Attack By Fire**

A tactical mission task in which a commander uses direct fires, supported by indirect fires, to engage an enemy without closing with him to destroy, suppress, fix, or deceive him

**Block**

A tactical mission task that denies the enemy access to an area or prevents his advance in a direction or along an avenue of approach.

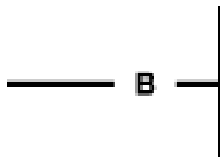
**Breach**

The employment of any means available to break through or secure a passage through an obstacle.

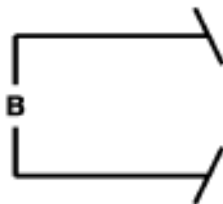

---

**Enemy-Oriented Tactical Tasks (Continued)**

---

**Bypass**

A tactical mission task in which the commander directs his unit to maneuver around an obstacle, avoiding combat with an enemy force.

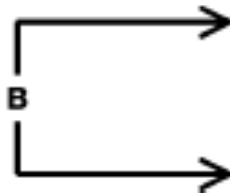
**Canalize**

A tactical mission task in which the commander restricts enemy movement to a narrow zone by exploiting terrain coupled with the use of obstacles, fires, or friendly maneuver.

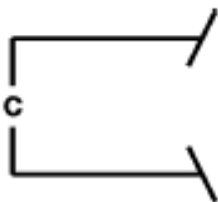
**Contain**

To stop, hold, or surround the forces of the enemy or to cause the enemy to center activity on a given front and to prevent the withdrawal of any part of the enemy's force for use elsewhere.

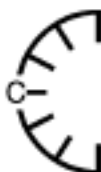
**Destroy**

A tactical mission task that physically renders an enemy force combat-ineffective until it is reconstituted.

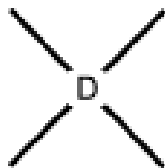

---

**Enemy-Oriented Tactical Tasks (Continued)**

---

**Disrupt**

A tactical mission task in which a commander integrates direct and indirect fires, terrain, and obstacles to upset an enemy's formation or tempo, interrupt his timetable, or cause his forces to commit prematurely or attack in piecemeal fashion.

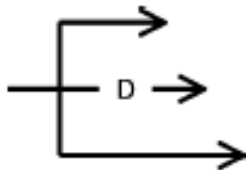
**Exploitation**

Taking full advantage of success in military operations, following up initial gains, and making permanent the temporary effects already achieved. Taking full advantage of any information that has come to hand for tactical, operational, or strategic purposes. An offensive operation that usually follows a successful attack and is designed to disorganize the enemy in depth.

**Feint**

A limited objective attack involving contact with the enemy, varying in size from a raid to a supporting attack. Feints are used to cause the enemy to react in three predictable ways:

- To employ reserves improperly.
- To shift supporting fires.
- To reveal defensive fires.

**Fix**

A tactical mission task where a commander prevents the enemy from moving any part of his force from a specific location for a specific period of time.

**Interdict**

A tactical mission task where the commander prevents, disrupts, or delays the enemy's use of an area or route.

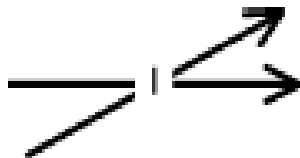

---

**Enemy-Oriented Tactical Tasks (Continued)**



---

**Neutralize**

To render enemy personnel or material incapable of interfering with a particular operation.

**Penetration**

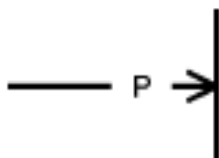
To break through the enemy's defense and disrupt his defensive system.

**Reconnoiter**

A mission undertaken to obtain, by visual observation or other detection methods, information about the activities and resources of an enemy or potential enemy.

**Rupture**

To create a gap in enemy defensive positions quickly.

**Support by Fire**

A tactical mission task in which a maneuver force moves to a position where it can engage the enemy by direct fire in support of another maneuvering force.

**Suppress**

A tactical mission task that results in temporary degradation of the performance of a force or weapons system below the level needed to accomplish the mission.



---

## Terrain-Oriented Tactical Tasks

---

**Clear**

A tactical mission task that requires the commander to remove all enemy forces and eliminate organized resistance in an assigned area.

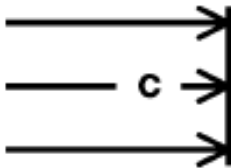
**Control**

A tactical mission task that requires the commander to maintain physical influence over a specified area to prevent its use by an enemy.

**Occupy**

A tactical mission task that involves a force moving into an area so that it can control the entire area. Both the force's movement to and occupation of the area occur without enemy opposition.

**Reconnoiter**

To secure data about the meteorological, hydrographic or geographic characteristics of a particular area.

**Retain**

A tactical task to occupy and hold a terrain feature to ensure that it is free of enemy occupation or use.

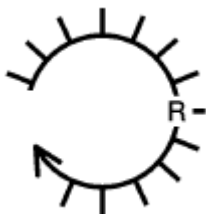

---

## Terrain-Oriented Tactical Tasks (Continued)

---

**Secure**

A tactical mission task that involves preventing a unit, facility, or geographical location from being damaged or destroyed as a result of enemy action.



**Seize**

---

To clear a designated area and obtain control of it.

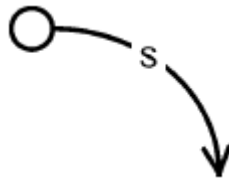

---

**Friendly-Oriented Tactical Tasks**

---

**Breach** To break through or secure a passage through a natural or friendly obstacle.

**Cover** Offensive or defensive actions to protect the force.

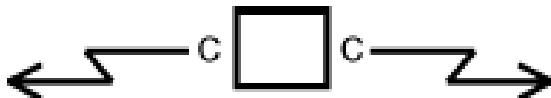

**Disengage** A tactical mission task where a commander has his unit break contact with the enemy to allow the conduct of another mission or to avoid decisive engagement.

**Displace** To leave one position and take another. Forces may be displaced laterally to concentrate combat power in threatened areas.

**Exfiltrate** The removal of personnel or units from areas under enemy control.

**Follow and Assume** A tactical mission task in which a second committed force follows a force conducting an offensive operation and is prepared to continue the mission if the lead force is fixed, attrited, or unable to continue.

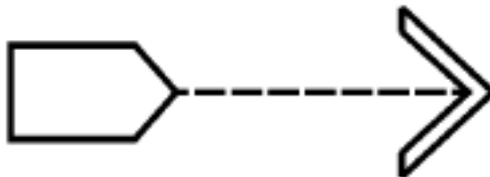

**Follow and Support** A tactical mission task in which a committed force follows and supports a lead force conducting an offensive operation

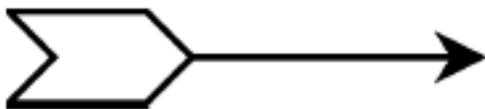

---

**Friendly-Oriented Tactical Tasks (Continued)**

---

**Guard**

A form of security operation whose primary task is to protect the main force by fighting to gain time while also observing and reporting information and to prevent enemy ground observation of and direct fire against the main body by reconnoitering, attacking, defending, and delaying. A guard force normally operates within the range of the main body's indirect fire weapons.

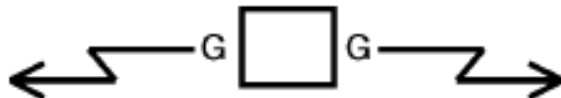

---

**Protect**

To prevent observation, engagement or interference with a force or location.

---

**Screen**

A form of security operation whose primary task is to observe, identify, and report information, and which only fights in self-protection.





---

## Fire Plan Overlay Symbols

---

**Fireplan**

A tactical plan for using the weapons of a unit, integrating them with the fires assigned by higher authority of other supporting weapons, is known as a fire plan. Fire plans are normally prepared and submitted in overlay form.

**Point Target**

A point target is a target of such small dimension that it requires the accurate placement of ordnance to neutralize or destroy it.

| **AB100** |

**Linear Target**

A linear target is a target whose length is

- More than 200 meters.
- Less the 600 meters.

Targets longer than 600 meters will require fire support other than indirect fire or may be subdivided into multiple targets for attack with indirect fire. A linear target is designated on the target list or list of targets by

- Two grids.
- A center grid, length, and attitude.

| **AB 1002** |

**Rectangular Target**

A rectangular target is a target wider and longer than 200 meters. It is designated on the target list or list of targets by

- Four grids.
- A center grid, length, width, and attitude.

**AB 1003**

---

**Fire Plan Overlay Symbols (Continued)**

---

**Circular Target**

A circular target is circular in nature or is vague as to its exact shape. It is designated by a center grid and a radius on the target list or list of targets.

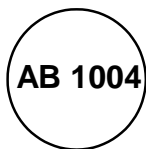

---

**Group of Targets**

A group is two or more targets that are attacked simultaneously. Groups give the maneuver commander the ability to hit different enemy positions at the same time without having to request individual targets. A group of targets is designated by an alpha/numeric combination. It is depicted on a map as in the example below.

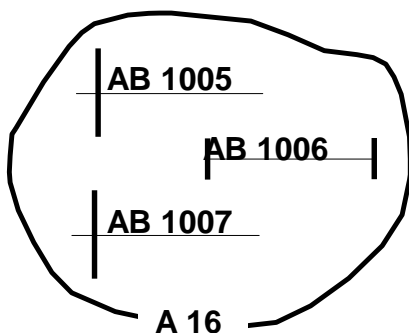

---

## Fire Plan Overlay Symbols (Continued)

---

### Series of Targets

A series is a number of targets and/or groups of targets fired in a timed sequence to support a maneuver phase. A series is indicated by a nickname.

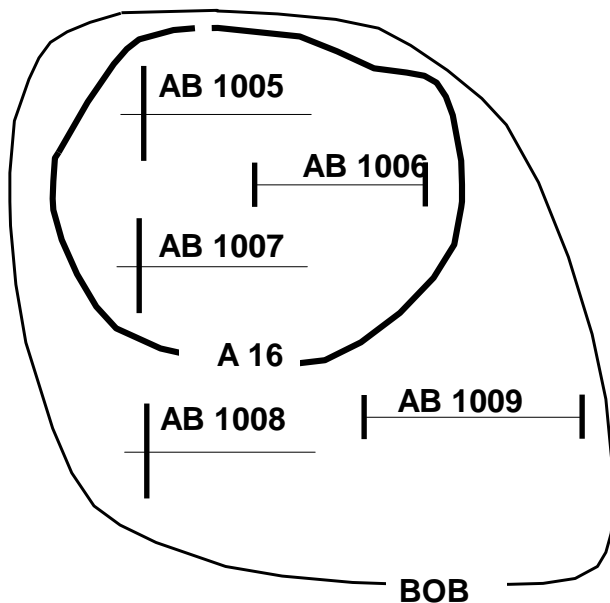

### Final Protective Fire (FPF)

The FPF is normally drawn to scale as a linear target. The symbol used includes the

- Target number.
- Designator of FPF.
- System/unit to deliver the fires.

| **AC1015** |  
**FPF**  
**C/1/10**

---

## Fire Plan Overlay Symbols (Continued)

---

**Target Reference Point (TRP)**

Maneuver elements use an easily identifiable TRP to orient direct-fire weapons systems. TRPs should be dually identified in terms of the direct-fire system and the target numbering system. The symbol is the same as that for a standard target with a target number and TRP letter. Only essential TRPs are integrated into the fire plan.

**NOTES:**

1. The difference in rectangular symbol for a barrage and an area target is the numbering. That is, an area target will have a regular target designation, and a barrage will show the unit designated to fire that particular barrage.
2. Mortar concentrations and barrages are numbered clockwise, regardless of size.

---

## Summary

---

The purpose of this programmed text has been to teach you to graphically portray units, installations, and activities on situation maps and overlays.

The basic symbol diagram distinguishes the type of unit. The specific type is designated within the unit symbol. The unit size is shown above the unit symbol, and the weapons are diagrammed below.

The unit designator (letter or number) is placed to the left of the unit symbol. The designators of senior units, up to the parent unit, are placed to the right.

Most symbols for non-division units and for fortifications and obstacles are self-explanatory.

A situation map graphically represents the tactical, intelligence, and/or logistical situation as it exists at a particular time. The map employs all the unit and activity symbols as well as colors to distinguish friendly, enemy, contaminated, and obstacle areas. Present and proposed unit locations and various tactical control measures are all symbolized on the situation map.

An overlay is a transparent or translucent medium upon which special military information has been plotted at the same scale of a map, photograph, or other graphic.

Now proceed to the self-test. The answers are provided at the end of the programmed text. You should not refer to the answer key before you have attempted to solve the problems.

---

**Self-Test**

---

**Self-Test Question 1** How many divisions are presently in the Marine Corps?  
 Answer: \_\_\_\_\_

**Self-Test Question 2** The 2d Marine Division is composed of the \_\_\_\_\_, \_\_\_\_\_, and \_\_\_\_\_ Marines (infantry regiments) and the \_\_\_\_\_ Marines (artillery regiment).

**Self-Test Question 3** Company "I" is always in the \_\_\_\_\_ Battalion.

**Self-Test Question 4** The 2d Battalion, 5th Marines contains the following companies: \_\_\_\_\_, \_\_\_\_\_, \_\_\_\_\_, and \_\_\_\_\_.

**Self-Test Question 5** Battery "G" is always in the \_\_\_\_\_ Battalion.

**Self-Test Question 6** The 3d Battalion, 12th Marines is in support of the \_\_\_\_\_ Marine Division.

**Self-Test Question 7** What are the complete written descriptions of the following units?

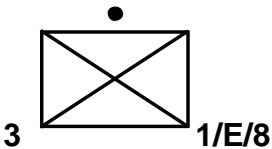
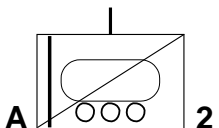
	a. _____
	b. _____

### Self-Test (Continued)

#### Self-Test Question 7 (Continued)

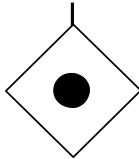
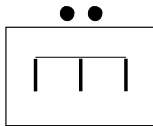
	c. _____
	d. _____

#### Self Test Question 8





Construct the unit symbols for the following units.

a. 2d Section, (Motorized) Anti-armor Platoon, Wpns Co, 3d Bn, 8th Mar, 2d Mar Div	c. Company B, 1st Bn, 8th Marines
b. Btry "A" 1st Bn, 11 Mar, 1st Mar Div	d. 60mm Mortar Sect, Wpns Plt, Co "G", 2d Bn, 7th Mar, 1st Mar Div
e. Command Post, Co "F", 2d Bn, 3d Mar, 3d Mar Div	_____

**Self-Test (Continued)**

**Self Test Question 9**

What are the complete written descriptions of the following weapons?

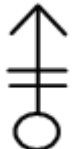
a. _____ 	c. _____ 
b. _____ 	d. _____ 
e. _____	

**Self Test Question 10**





Construct the symbols for the following weapons.

a. AT-4 rocket launcher in antitank role		c. .50 cal MG	
b. Four 105mm howitzers		d. Two heavy mortars	

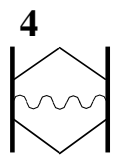

**Self-Test (Continued)**

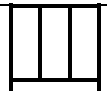
**Self Test Question 11** What are the complete written descriptions of the following symbols?

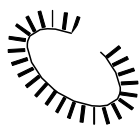
 <p>4</p>	<p>a. _____ _____</p>		<p>c. _____ _____</p>
	<p>b. _____</p>		<p>d. _____</p>
		<p>e. _____ _____</p>	

**Self Test Question 12** What color is used on a situation map to show enemy units, installations, or equipment?

Answer: \_\_\_\_\_

**Self Test Question 13** A proposed or future location of a unit is shown with a \_\_\_\_\_ line symbol.

**Self Test Question 14** A transparent or translucent medium upon which special military information has been plotted at the same scale of a map is a/an \_\_\_\_\_.

## Self-Test Answer Key

**Self-Test Answer 1** How many divisions are presently in the Marine Corps?  
 Answer: Presently the Marine Corps has four divisions (three active and one reserve).

**Self-Test Answer 2** The 2d Marine Division is composed of the 2d, 6<sup>th</sup>, and 8th Marines (infantry regiments) and the 10th Marines (artillery regiment).

**Self-Test Answer 3** Company "I" is always in the 3d Battalion.

**Self-Test Answer 4** The 2d Battalion, 5th Marines contains the following companies: E, F, G, Weapons Company, and Headquarters Service Company.

**Self-Test Answer 5** Battery "G" is always in the 2d Battalion.

**Self-Test Answer 6** The 3d Battalion, 12th Marines is in support of the 3d Marine Division.

**Self-Test Answer 7** What are the complete written descriptions of the following units?

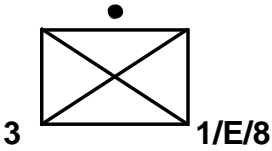
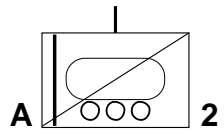
	<p>a. <u>3d Sq d., 1st Plt, Co "E,"</u>  <u>2d Bn, 8th Mar, 2d Mar Div</u></p>
	<p>b. <u>Co "A," 2d LAR Bn,</u>  <u>2d Mar Div</u></p>

**Self-Test Answer Key (Continued)**

**Self-Test Answer 7  
(Continued)**

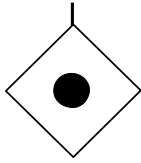
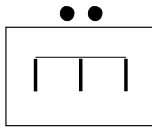
	<p>c. <u>Enemy artillery battery</u></p>
	<p>d. <u>Combat engineer section</u></p>

**Self Test Answer 8**



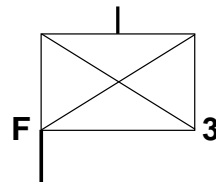
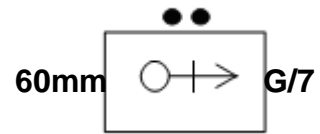
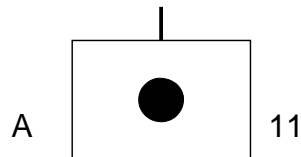
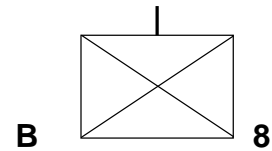
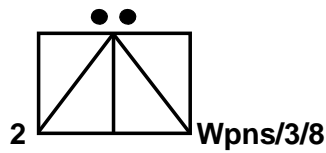

Construct the unit symbols for the following units.

<p>a. 2d Section, (Motorized) Anti-armor Platoon, Wpns Co, 3d Bn, 8th Mar, 2d Mar Div</p>	<p>c. Company B, 1st Bn, 8th Marines</p>
<p>b. Btry "A" 1st Bn, 11 Mar, 1st Mar Div</p>	<p>d. 60mm Mortar Sect, Wpns Plt, Co "G", 2d Bn, 7th Mar, 1st Mar Div</p>
<p>e. Command Post, Co "F", 2d Bn, 3d Mar, 3d Mar Div</p>	





**Self-Test Answer Key (Continued)****Self Test Answer 9**

What are the complete written descriptions of the following weapons?

<p>a. <u>Two 7.62mm machine guns</u></p>	<p>2</p> 	<p>c. <u>Mk19 40mm grenade launcher</u></p>	
<p>b. <u>TOW antitank missile</u></p>		<p>d. <u>Light howitzer (105mm)</u></p>	
<p>e. <u>81mm mortar</u></p>			

**Self Test Answer 10**

Construct the symbols for the following weapons.

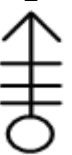

<p>a. AT-4 rocket launcher in antitank role</p>	<p>84</p> 	<p>c. .50 cal MG</p>	
<p>b. Four 105mm howitzers</p>	<p>4</p> 	<p>d. Two heavy mortars</p>	<p>2</p> 

---

**Self-Test Answer Key (Continued)**

---

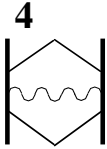
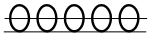
**Self Test Answer 11**      What are the complete written descriptions of the following symbols?

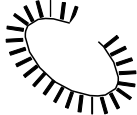
	<p>a. <u>Four assault amphibian vehicles (AAVs)</u></p>		<p>c. <u>Double concertina wire</u></p>
	<p>b. <u>Heavy tank (M1A1)</u></p>		<p>d. <u>Antitank ditch</u></p>
		<p>e. <u>Enemy strongpoint</u></p>	

---

**Self Test Answer 12**      What color is used on a situation map to show enemy units, installations, or equipment?

Answer: Red is used on a situation map to show enemy units, installations, or equipment

---

**Self Test Answer 13**      A proposed or future location of a unit is shown with a broken line symbol.

---

**Self Test Answer 14**      A transparent or translucent medium upon which special military information has been plotted at the same scale of a map is a/an overlay.

---

## References

---

Reference Number or Author	Reference Title
MCWP 3-1,	Ground Combat Operations
MIL-STD-2525D	Joint Military Symbology
MCDP 1-0	Marine Corps Operations

---

## Glossary of Terms and Acronyms

---

Term or Acronym	Definition or Identification
AA	assembly area
AAV Bn	Amphibious assault vehicle battalion
Arty	artillery
Aslt	assault
BLT	battle landing team
Bn & Div HQ	Battalion and division headquarters
BP	battle position
CFL	coordinated fire line
Combat Engr Bn	Combat engineer battalion
Comm Co	Communications company
CP	command post
CP	check point
ENY	enemy
FCL	final coordination line
FEBA	forward edge of the battle area
FPF	final protective fire
FSCL	fire support coordination line
H&S Co	Headquarters and Service Company
HQ Co	Headquarters company
LAR Bn	Light armored reconnaissance battalion
LD	line of departure
LU	linkup point
LZ	landing zone
MAGTF	Marine Air Ground Task Force
Mar Div	Marine division
MEF	Marine Expeditionary Force
MEU	Marine Expeditionary Unit
MP Co	Military police company
Obj	objective
PD	point of departure
PL	phase line
Pos	position

**Glossary of Terms and Acronyms (Continued)**

<b>Term or Acronym</b>	<b>Definition or Identification</b>
PP	passage point
Recon Bn	Reconnaissance battalion
Rein	reinforced
RFL	restricted fire line
RP	release point
SPI	self paced instruction
SVC Co	Service company
TRP	target reference point
UDP	Unit Deployment Program
Wpns Co	Weapons Company

**Notes**

---

---

---

---

---

---

---

---

---

---

---

---

---

---

---

---

---

---

---

---

---

---

---

---

---

---

---

---

---

---