

FM 6-50
MCWP 3-16.3

Tactics, Techniques, and Procedures for the Field Artillery Cannon Battery



U.S. Marine Corps

PCN 143 000004 00

MCCDC (C 42)
24 JUN 1998

E R R A T U M

to

MCWP 3-16.3

TACTICS, TECHNIQUES, AND PROCEDURES FOR THE FIELD
ARTILLERY CANNON BATTERY

1. For administrative purposes the publication short title has been reidentified. Change "MCWP 3-1.6.23" to read: "MCWP 3-16.3" of January 1996 wherever it appears in the Manual.

PCN 143 000004 80

FOREWORD

This publication may be used by the US Army and US Marine Corps forces during training, exercises, and contingency operations.

General, USA
Commanding
Training and Doctrine Command

Lieutenant General, USMC
Commanding General
Marine Corps Combat Development Command



PREFACE

This publication is designed primarily for the cannon battery. It is a how-to-train manual intended to provide general guidance to the commander and his principal subordinates. It is designed for battery leaders and should be used in conjunction with equipment technical manuals, Marine Corps combat readiness evaluation system (MCCRES), Marine Corps individual training standards (ITS), Army training and evaluation program (ARTEP) mission training plans (AMTPs), soldier manuals, and trainer's guides.

This publication sets forth suggested duties and responsibilities of key personnel and addresses doctrine and procedures for cannon battery operations and training. It is based on current tables of organization and equipment (TOE) and provides a starting point from which each commander can adjust his battery operations and training based on his modification tables of organization and equipment (MTOE); actual personnel and equipment till; local training scenario; and mission, enemy, terrain, troops, and time available (METT-T).

This publication presents standardized procedures relevant to cannon battery operations (Appendix A). These procedures are denoted in text by an asterisk (*).

This publication implements the following North Atlantic Treaty Organization (NATO) standardization agreements (STANAGs) and quadripartite standardization agreements (QSTAGs):

STANAG 2934, Edition 1, Chapter 13, *Artillery Procedures*, and QSTAG 503, Edition 2, *Bombing, Shelling, Rocketing, Mortaring and Location Reports*.

STANAG 2041, Edition 4 and QSTAG 520, Edition 1, *Operation Orders, Tables and Graphs for Road Movement*.

STANAG 2047, Edition 6, and QSTAG 183, Edition 3, *Emergency Alarms of Hazard or Attack (NBC and Air Attack Only)*.

STANAG 2113, Edition 5, *Denial of A Unit's Military Equipment and Supplies to an Enemy*.

STANAG 2154, Edition 5 and QSTAG 539, Edition 1, *Regulations for Military Motor Vehicle Movement by Road*.

As used throughout this publication, the words *howitzer*, *gun*, *cannon*, *weapon*, and *piece* are synonymous.

The proponent of this publication is HQ TRADOC. Send comments and recommendations on DA Form 2028 (Recommended Changes to Publications and Blank Forms) directly to:

Commandant
US Army Field Artillery School
ATTN: ATSF-DD
Fort Sill, Oklahoma 73503-5600

Unless this publication states otherwise, masculine nouns and pronouns do not refer exclusively to men.

P R E F A C E

This publication is designed primarily for the cannon battery. It is a how-to-train manual intended to provide general guidance to the commander and his principal subordinates. It is designed for battery leaders and should be used in conjunction with equipment technical manuals, Marine Corps combat readiness evaluation system (MCCRES), Marine Corps individual training standards (ITS), Army training and evaluation program (ARTEP) mission training plans (AMTPs), soldier manuals, and trainer's guides.

This publication sets forth suggested duties and responsibilities of key personnel and addresses doctrine and procedures for cannon battery operations and training. It is based on current tables of organization and equipment (TOE) and provides a starting point from which each commander can adjust his battery operations and training based on his modification tables of organization and equipment (MTOE); actual personnel and equipment till; local training scenario; and mission, enemy, terrain, troops, and time available (METT-T).

This publication presents standardized procedures relevant to cannon battery operations (Appendix A). These procedures are denoted in text by an asterisk (*).

This publication implements the following North Atlantic Treaty Organization (NATO) standardization agreements (STANAGs) and quadripartite standardization agreements (QSTAGs):

STANAG 2934, Edition 1, Chapter 13, *Artillery Procedures*, and QSTAG 503, Edition 2, *Bombing, Shelling, Rocketing, Mortaring and Location Reports*.

STANAG 2041, Edition 4 and QSTAG 520, Edition 1, *Operation Orders, Tables and Graphs for Road Movement*.

STANAG 2047, Edition 6, and QSTAG 183, Edition 3, *Emergency Alarms of Hazard or Attack (NBC and Air Attack Only)*.

STANAG 2113, Edition 5, *Denial of A Unit's Military Equipment and Supplies to an Enemy*.

STANAG 2154, Edition 5 and QSTAG 539, Edition 1, *Regulations for Military Motor Vehicle Movement by Road*.

As used throughout this publication, the words *howitzer*, *gun*, *cannon*, *weapon*, and *piece* are synonymous.

The proponent of this publication is HQ TRADOC. Send comments and recommendations on DA Form 2028 (Recommended Changes to Publications and Blank Forms) directly to:

Commandant
US Army Field Artillery School
ATTN: ATSF-DD
Fort Sill, Oklahoma 73503-5600

Unless this publication states otherwise, masculine nouns and pronouns do not refer exclusively to men.

FIELD MANUAL
No. 6-50
MARINE CORPS WARFIGHTING PUBLICATION
No. 3-1.6.23

HEADQUARTERS
DEPARTMENT OF THE ARMY
UNITED STATES MARINE CORPS
Washington, DC, 23 December 1996

Tactics, Techniques, and Procedures for
THE FIELD ARTILLERY CANNON BATTERY

Table of Contents

| | PAGE |
|---|------------|
| PREFACE | xiv |
| CHAPTER 1 | |
| MISSION, ORGANIZATION, AND KEY PERSONNEL | |
| Section I | |
| MISSION AND GENERAL ORGANIZATION | 1-1 |
| 1-1. MISSION | 1-1 |
| 1-2. FIELD ARTILLERY ORGANIZATION | 1-1 |
| 1-3. COMMAND AND CONTROL OF BATTERIES | 1-1 |
| Section II | |
| CANNON BATTERIES IN PLATOON-BASED FIELD ARTILLERY BATTALIONS | 1-3 |
| 1-4. ORGANIZATION | 1-3 |
| 1-5. TACTICAL DUTIES OF KEY PERSONNEL | 1-4 |
| 1-6. BATTERY COMMANDER | 1-4 |
| 1-7. FIRST SERGEANT | 1-4 |
| 1-8. PLATOON LEADER | 1-4 |
| 1-9. FIRE DIRECTION OFFICER | 1-5 |
| 1-10. PLATOON SERGEANT | 1-5 |
| 1-11. GUNNERY SERGEANT | 1-5 |
| 1-12. HOWITZER SECTION CHIEF | 1-5 |

DISTRIBUTION RESTRICTION: Approved for public release, distribution is unlimited.

*This publication supersedes FM 6-50, 20 November 1990.

MARINE CORPS PCN: 143 000004 00

Section III

CANNON BATTERIES IN BATTERY-BASED FIELD ARTILLERY BATTALIONS 1-6

- 1-13. ORGANIZATION 1-6
- 1-14. TACTICAL DUTIES OF KEY PERSONNEL 1-6
- 1-15. BATTERY COMMANDER 1-6
- 1-16. FIRST SERGEANT 1-8
- 1-17. EXECUTIVE OFFICER 1-8
- 1-18. ASSISTANT EXECUTIVE OFFICER (USMC only) 1-8
- 1-19. FIRE DIRECTION OFFICER 1-8
- 1-20. CHIEF OF FIRING BATTERY 1-9
- 1-21. GUNNERY SERGEANT 1-9
- 1-22. HOWITZER SECTION CHIEF 1-9

CHAPTER 2

**RECONNAISSANCE, SELECTION, AND
OCCUPATION OF A POSITION**

Section I

RECONNAISSANCE AND THE ADVANCE PARTY 2-1

- 2-1. DEFINITION AND REQUIREMENTS 2-1
- 2-2. CONSIDERATIONS 2-1
- 2-3. RECEIPT OF THE ORDER 2-1
- 2-4. ARTILLERY TROOP LEADING PROCEDURES 2-1
- 2-5. RSOP OPERATIONS 2-2
- 2-6. METHODS OF RECONNAISSANCE 2-2
- 2-7. PLANNING THE RECONNAISSANCE 2-3
- 2-8. THE RECONNAISSANCE PARTY 2-4
- 2-9. ASSEMBLING THE ADVANCE PARTY 2-4
- 2-10. TAKING A FIRING CAPABILITY FORWARD 2-6
- 2-11. MOVEMENT BRIEFING 2-6
- 2-12. ROUTE RECONNAISSANCE 2-7

Section II

SELECTING THE NEW POSITION 2-8

- 2-13. POSITION SELECTION CONSIDERATIONS 2-8
- 2-14. TYPES OF POSITIONS 2-8

Section III

ORGANIZING THE NEW POSITION 2-8

| | | |
|---|--------------------------------------|-------------|
| 2-15. | ADVANCE PARTY PREPARATIONS | 2-8 |
| 2-16. | FORMATIONS | 2-10 |
| Section IV | | |
| PREPARATION FOR OCCUPATION | | 2-12 |
| 2-17. | DAYTIME OCCUPATION | 2-12 |
| 2-18. | LIMITED TIME PREPARATIONS | 2-15 |
| 2-19. | NIGHT OCCUPATION | 2-15 |
| 2-20. | SECTION CHIEF'S REPORT | 2-16 |
| Section V | | |
| TACTICAL MARCHES | | 2-18 |
| 2-21. | METHODS OF MOVEMENT | 2-18 |
| 2-22. | OPEN COLUMN | 2-18 |
| 2-23. | CLOSE COLUMN | 2-18 |
| 2-24. | INFILTRATION | 2-19 |
| 2-25. | TERRAIN MARCH | 2-19 |
| Section VI | | |
| PREPARING FOR MOVEMENT | | 2-20 |
| 2-26. | ORDERS | 2-20 |
| 2-27. | LOAD PLANS | 2-20 |
| 2-28. | MOVEMENT PREPARATIONS | 2-20 |
| 2-29. | ORGANIZATION OF THE COLUMN | 2-20 |
| Section VII | | |
| CONDUCTING THE MARCH | | 2-21 |
| 2-30. | MARCH DISCIPLINE | 2-21 |
| 2-31. | CONVOY CONTROL MEASURES | 2-21 |
| 2-32. | HALTS | 2-22 |
| 2-33. | MARCH COLUMN CONTINGENCIES | 2-22 |
| 2-34. | OTHER MOVEMENTS | 2-23 |
| 2-35. | MOVEMENT PROCEDURES | 2-23 |
| Section VIII | | |
| OCCUPYING THE POSITION | | 2-33 |
| 2-36. | TYPES OF OCCUPATION | 2-33 |
| 2-37. | DELIBERATE OCCUPATION | 2-33 |
| 2-38. | HASTY OCCUPATION | 2-33 |
| 2-39. | EMERGENCY OCCUPATION | 2-33 |
| 2-40. | SUSTAINING ACTIONS | 2-34 |
| 2-41. | TRAINING TIPS | 2-35 |

CHAPTER 3
BATTERY DEFENSE

Section I

INTRODUCTION 3-1

 3-1. THREAT CAPABILITIES 3-1

 3-2. BATTERY RESPONSIBILITIES 3-2

Section II

CONSIDERATIONS FOR DEFENSE 3-2

 3-3. USE OF TERRAIN 3-2

 3-4. DEFENSE IN DEPTH 3-3

 3-5. SECURITY 3-3

 3-6. DISPERSION 3-6

 3-7. PRIORITIES 3-6

 3-8. DEFENSE IN ALL DIRECTIONS 3-6

 3-9. MUTUAL SUPPORT 3-6

 3-10. CONTROL 3-6

 3-11. FLEXIBILITY 3-7

Section III

DEFENSE DIAGRAM 3-9

 3-12. PURPOSE 3-9

 3-13. CONSTRUCTION OF THE DIAGRAM 3-9

 3-14. DISPOSITION OF THE DIAGRAM 3-9

 3-15. PREPARING RANGE CARDS 3-9

Section IV

CONDUCT OF THE DEFENSE 3-17

 3-16. DEFENSE AGAINST ENEMY ARMOR/MECHANIZED FORCE 3-17

 3-17. DEFENSE AGAINST AIR ATTACK 3-17

 3-18. DEFENSE AGAINST DISMOUNTED ATTACK 3-18

 3-19. DEFENSE IN OPERATIONS OTHER THAN WAR (OOTW) 3-18

 3-20. DEFENSE AGAINST INDIRECT FIRE 3-18

 3-21. DEFENSE AGAINST NBC ATTACK 3-19

 3-22. EQUIPMENT AND MATERIEL DESTRUCTION PROCEDURES 3-19

 3-23. EMERGENCY ALARMS OF HAZARD OR ATTACK 3-21

 3-24. BOMBING, SHELLING, ROCKETING, MORTARING, AND LOCATION REPORTS . . . 3-23

CHAPTER 4
LAYING THE BATTERY, MEASURING, AND REPORTING

Section I

THE AIMING CIRCLE 4-1

4-1. DESCRIPTION OF THE AIMING CIRCLE 4-1

4-2. SETTING UP THE AIMING CIRCLE 4-3

4-3. LEVELING THE AIMING CIRCLE 4-3

4-4. TAKING DOWN THE AIMING CIRCLE 4-4

4-5. DECLINATING THE AIMING CIRCLE 4-5

4-6. CARE AND HANDLING OF THE AIMING CIRCLE 4-6

Section II

PRECISION LIGHTWEIGHT GPS RECEIVER (PLGR) 4-6

4-7. GLOBAL POSITIONING SYSTEM DESCRIPTION 4-6

4-8. FA SURVEY APPLICATIONS 4-6

4-9. GPS LIMITATIONS AND CONSIDERATIONS 4-8

SECTION III

GUN LAYING AND POSITIONING SYSTEM 4-8

4-10. DESCRIPTION OF THE GUN LAYING AND POSITIONING SYSTEM 4-8

Section IV

THE M2 COMPASS 4-10

4-11. DESCRIPTION OF THE M2 COMPASS 4-10

4-12. DECLINATING THE M2 COMPASS 4-10

4-13. MEASURING AN AZIMUTH AND SITE TO CREST WITH THE M2 COMPASS 4-11

4-14. CARE AND HANDLING OF THE M2 COMPASS 4-11

Section V

LAYING 4-11

4-15. PRINCIPLES OF LAYING 4-11

4-16. PROCEDURES FOR LAYING 4-12

4-17. LAYING BY ORIENTING ANGLE 4-13

4-18. LAYING BY GRID AZIMUTH 4-14

4-19. COMMANDS 4-15

4-20. LAYING BY ALTERNATE METHODS 4-16

4-21. M2 COMPASS METHOD 4-16

4-22. AIMING POINT-DEFLECTION METHOD 4-17

4-23. HOWITZER BACK-LAY METHOD 4-18

4-24. ESTABLISHING AIMING POINTS 4-19

4-25. SAFETY AND VERIFYING THE LAY OF THE PLATOON 4-20
 4-26. MEASURING VERTICAL ANGLES 4-21
 4-27. MEMORY AIDS 4-22

Section VI

MEASURING AND REPORTING DATA 4-24
 4-28. ACCURACY 4-24
 4-29. BACKWARD AZIMUTH RULE 4-24
 4-30. REPORTING THE CORRECT DEFLECTION 4-24
 4-31. MEASURING THE AZIMUTH OF THE LINE OF FIRE 4-24
 4-32. CORRECTING BORESIGHT ERROR 4-26
 4-33. TRAINING 4-27

**CHAPTER 5
 HASTY SURVEY TECHNIQUES**

Section I

SURVEY CONTROL 5-1
 5-1. REQUIREMENTS 5-1
 5-2. ELEMENTS OF SURVEY CONTROL 5-1

Section II

DIRECTION 5-2
 5-3. SIMULTANEOUS OBSERVATION 5-2
 5-4. POLARIS-KOCHAB METHOD 5-3
 5-5. POLARIS 2 METHOD 5-10
 5-6. DIRECTIONAL TRAVERSE 5-11

Section III

LOCATION 5-13
 5-7. METHODS OF LOCATION 5-13
 5-8. GRAPHIC RESECTION 5-13
 5-9. GRAPHIC TRAVERSE 5-14
 5-10. DISTANCE MEASURING 5-15
 5-11. AUTOMATED COMPUTATIONS 5-23
 5-12. AFU INPUT FOR GRAPHIC TRAVERSE USING BUCS, REV 1 5-23
 5-13. ALTITUDE DETERMINATION 5-25

CHAPTER 6

MINIMUM QUADRANT ELEVATION

6-1. RESPONSIBILITIES 6-1
 6-2. ELEMENTS OF COMPUTATION 6-1
 6-3. MEASURING ANGLE OF SITE TO CREST 6-2
 6-4. MEASURING PIECE-TO-CREST RANGE 6-2
 6-5. COMPUTATION FOR FUZES OTHER THAN ARMED VARIABLE TIME 6-2
 6-6. COMPUTING FOR ARMED VT FUZES (LOW-ANGLE FIRE) 6-3

CHAPTER 7

FIRE COMMANDS AND FIRING REPORTS

7-1. DEFINITIONS 7-1
 7-2. SEQUENCE OF FIRE COMMANDS 7-1
 7-3. TYPES OF FIRE COMMANDS 7-2
 7-4. ELEMENTS OF THE FIRE COMMAND 7-2
 7-5. WARNING ORDER 7-2
 7-6. PIECES TO FOLLOW, PIECES TO FIRE, AND METHOD OF FIRE 7-2
 7-7. SPECIAL INSTRUCTIONS 7-3
 7-8. PROJECTILE 7-5
 7-9. AMMUNITION LOT 7-5
 7-10. CHARGE 7-5
 7-11. FUZE 7-5
 7-12. FUZE SETTING 7-5
 7-13. DEFLECTION 7-5
 7-14. QUADRANT ELEVATION 7-5
 7-15. METHOD OF FIRE FOR EFFECT 7-6
 7-16. SPECIAL METHODS OF FIRE 7-6
 7-17. CHECK FIRING 7-6
 7-18. CEASE LOADING 7-6
 7-19. END OF MISSION 7-7
 7-20. PLANNED TARGETS 7-7
 7-21. REPETITION AND CORRECTION OF FIRE COMMANDS 7-7
 7-22. FIRING REPORTS 7-7
 7-23. STANDARDIZING ELEMENTS OF THE FIRE COMMAND 7-7
 7-24. EXAMPLE OF FIRE COMMANDS 7-8
 7-25. RECORD OF MISSIONS FIRED 7-10

CHAPTER 8
SPECIAL SITUATIONS

| | | |
|------|---|-----|
| 8-1. | DIRECT FIRE | 8-1 |
| 8-2. | DIRECT FIRE SIGHTING METHODS | 8-1 |
| 8-3. | DIRECT FIRE LAYING METHODS | 8-2 |
| 8-4. | COMMANDS FOR DIRECT FIRE | 8-2 |
| 8-5. | EMERGENCY BORESIGHTING | 8-3 |
| 8-6. | COLLIMATOR METHOD OF BORESIGHTING | 8-3 |
| 8-7. | STANDARD ANGLE METHOD OF BORESIGHTING | 8-3 |
| 8-8. | AIMING CIRCLE METHOD OF BORESIGHTING | 8-3 |

CHAPTER 9
COMMUNICATIONS

| | | |
|------|--|-----|
| 9-1. | COMMUNICATIONS EQUIPMENT | 9-1 |
| 9-2. | BATTERY COMMUNICATIONS SECTION | 9-1 |
| 9-3. | BATTERY WIRE SYSTEM | 9-1 |
| 9-4. | BATTERY RADIO NET STRUCTURE | 9-4 |
| 9-5. | AN/PRC-68 AND AN/PRC-126 PLANNING CONSIDERATIONS | 9-7 |
| 9-6. | BCS-TO-GDU COMMUNICATIONS | 9-8 |

CHAPTER 10
AMMUNITION

| | | |
|--------|--|------|
| 10-1. | REFERENCES | 10-1 |
| 10-2. | EXTERIOR COMPONENTS OF AN ARTILLERY PROJECTILE | 10-1 |
| 10-3. | PROJECTILE PAINTING AND MARKING | 10-2 |
| 10-4. | CARE AND HANDLING OF AMMUNITION | 10-3 |
| 10-5. | PROJECTILES | 10-3 |
| 10-6. | FUZES | 10-4 |
| 10-7. | PROPELLING CHARGES | 10-4 |
| 10-8. | FLASH REDUCERS | 10-5 |
| 10-9. | PRIMERS | 10-5 |
| 10-10. | CARTRIDGE CASES | 10-5 |
| 10-11. | SEGREGATION OF AMMUNITION LOTS | 10-6 |
| 10-12. | FIELD STORAGE OF AMMUNITION | 10-6 |
| 10-13. | STORAGE AND TRANSPORTATION TECHNIQUES | 10-7 |
| 10-14. | ACCIDENTS | 10-7 |
| 10-15. | MISFIRE PROCEDURES | 10-7 |

10-16. TRAINING 10-7
10-17. AMMUNITION PLANNING GUIDE 10-8

CHAPTER 11
SAFETY PROCEDURES

11-1. RESPONSIBILITIES 11-1
11-2. DUTIES OF SAFETY PERSONNEL 11-2
11-3. SAFETY AIDS 11-3
11-4. SAFETY COMPUTATIONS 11-4

CHAPTER 12
COMBAT SERVICE SUPPORT

12-1. RESPONSIBILITIES 12-1
12-2. BATTALION TRAIN 12-1
12-3. LOGISTICS PACKAGES 12-1
12-4. BATTERY INTERFACE WITH THE ALOC 12-1
12-5. CLASSES OF SUPPLY 12-2
12-6. MAINTENANCE, RECOVERY, AND REPAIR 12-3
12-7. REFUEL, REARM, AND RESUPPLY POINT 12-4

APPENDIX A
STANDARDIZED PROCEDURES

APPENDIX B
SAMPLE GUNNER'S QUALIFICATION TEST

B-1. USE OF TEST B-1
B-2. STANDARDS OF PRECISION B-1
B-3. ASSISTANCE B-1
B-4. TASK SCORING B-1
B-5. QUALIFICATION SCORES B-1
B-6. EQUIPMENT, PERSONNEL, AND SITE REQUIREMENTS B-2
B-7. TASKS B-5

APPENDIX C
SAMPLE OPERATIONS CHECKLISTS

C-1. DESCRIPTION C-1
C-2. PRECOMBAT CHECKLISTS C-1
C-3. BATTERY STATUS INVENTORY C-4

C-4. CRITICAL EVENTS TIME LINE C-5
C-5. BATTERY WARNING ORDER C-5
C-6. BATTERY ORDER C-8

APPENDIX D

COMMON MISTAKES AND MALPRACTICES

D-1. PROBLEM AREAS D-1
D-2. PRECUTTING CHARGES D-1
D-3. LAYING ON THE WRONG AIMING POSTS D-1
D-4. IMPROPER EMPLACEMENT OF AIMING POINTS D-1
D-5. FAILURE TO COMPUTE TERRAIN GUN POSITION CORRECTIONS D-3
D-6. USING THE M139 OR M140 ALIGNMENT DEVICE TO VERIFY BORESIGHT D-4
D-7. OTHER MISTAKES D-4
D-8. MALPRACTICES D-4
D-9. ERRORS IN SETTING UP AND ORIENTING THE AIMING CIRCLE D-5
D-10. INCIDENTS D-6

APPENDIX E

**LOAD PLANS FOR HOWITZER AMMUNITION
VEHICLES AND CAMOUFLAGE CONFIGURATION**

APPENDIX F

SPECIAL OPERATIONS

F-1. OPERATIONS IN MOUNTAINOUS TERRAIN F-1
F-2. OPERATIONS IN JUNGLE TERRAIN F-1
F-3. NORTHERN OPERATIONS F-1
F-4. MILITARY OPERATIONS ON URBANIZED TERRAIN F-2
F-5. DESERT OPERATIONS F-2
F-6. AMPHIBIOUS ASSAULT F-3
F-7. AIR ASSAULT OPERATIONS F-3
F-8. ARTILLERY RAIDS F-5
F-9. OPERATIONS OTHER THAN WAR (OOTW) F-6
F-10. FIRE BASE/HARDENED ARTILLERY POSITION OPERATIONS F-7
F-11. EMERGENCY OCCUPATION PROCEDURES WITH BCS F-11

APPENDIX G

CANNON SECTION EVALUATION AND TRAINING

| | | |
|-------|---|------|
| G-1. | SCOPE | G-1 |
| G-2. | PURPOSE | G-1 |
| G-3. | CONDUCT OF THE EVALUATION | G-1 |
| G-4. | EVALUATION FORMAT | G-1 |
| G-5. | SCORING | G-1 |
| G-6. | PREPARATION | G-1 |
| G-7. | QUALIFICATION | G-2 |
| G-8. | ORGANIZATION AND SCORING | G-2 |
| G-9. | PHASE I, ORIENTATION AND ORGANIZATION | G-4 |
| G-10. | PHASE II, PREPARATION FOR FIRING OPERATIONS | G-6 |
| G-11. | PHASE III, DELIBERATE OCCUPATION | G-8 |
| G-12. | PHASE IV, FIRE MISSIONS | G-10 |
| G-13. | PHASE V, CRITIQUE | G-12 |

APPENDIX H

UNIT DEFENSE CHECKLIST

| | | |
|-------|--|-----|
| H-1. | ENTRANCE POINT | H-1 |
| H-2. | PASSIVE DEFENSIVE TECHNIQUES | H-1 |
| H-3. | ACTIVE DEFENSIVE TECHNIQUES | H-1 |
| H-4. | PERIMETER COMMUNICATIONS | H-2 |
| H-5. | ANTIARMOR ASSETS | H-2 |
| H-6. | MOVEMENT | H-2 |
| H-7. | LOCAL SECURITY | H-3 |
| H-8. | NUCLEAR, BIOLOGICAL AND CHEMICAL | H-3 |
| H-9. | AIR DEFENSE COVERAGE | H-3 |
| H-10. | MEDICAL | H-4 |
| H-11. | ENEMY PRISONERS OF WAR (EPWs) | H-4 |

APPENDIX I

KILLER JUNIOR

| | | |
|------|----------------------------|-----|
| I-1. | DESCRIPTION | I-1 |
| I-2. | TYPES OF TARGETS | I-1 |
| I-3. | AMMUNITION | I-1 |
| I-4. | PROCEDURES | I-1 |

APPENDIX J

CRATER ANALYSIS AND REPORTING

J-1. CRATER ANALYSIS TEAM J-1
J-2. EQUIPMENT J-1
J-3. SHELL CRATER ANALYSIS J-1
J-4. VALUE OF ANALYSIS J-2
J-5. INSPECTION OF SHELLED AREAS J-2
J-6. SURVEY OF CRATER LOCATION J-2
J-7. DETERMINATION OF DIRECTION J-2
J-8. CRATER ANALYSIS J-2
J-9. LOW-ANGLE FUZE QUICK CRATERS (ARTILLERY) J-2
J-10. LOW-ANGLE FUZE DELAY CRATERS (ARTILLERY) J-3
J-11. HIGH-ANGLE SHELL CRATERS (MORTARS) J-4
J-12. ROCKET CRATERS J-5
J-13. SHELL FRAGMENT ANALYSIS J-6
J-14. SHELLING REPORTS J-10

APPENDIX K

MINIMUM QUADRANT ELEVATION RAPID FIRE TABLES

K-1. DESCRIPTION OF THE TABLES K-1
K-2. USE OF THE RAPID FIRE TABLES K-1

APPENDIX L

GUN DISPLAY UNIT

L-1. DESCRIPTION L-1
L-2. SECTION CHIEF'S ASSEMBLY L-1
L-3. CASE ASSEMBLY L-3
L-4. GUN ASSEMBLY L-4
L-5. CABLES L-5
L-6. BCS - GDU WIRE LINK L-5
L-7. WIRE OPERATIONS L-6
L-8. M109-SERIES HOWITZERS L-9
L-9. GUN DISPLAY UNIT POWER L-9
L-10. TOWED HOWITZERS L-10
L-11. SELF-PROPELLED HOWITZER POWER SOURCE L-13
L-12. INOPERATIVE GUN DISPLAY UNIT L-13

| | | |
|-------|-----------------------------------|------|
| L-13. | SMALL UNIT TRANSCEIVERS | L-13 |
| L-14. | PREVENTIVE MAINTENANCE | L-14 |

APPENDIX M
SELECTED CHARACTERISTICS OF FIELD ARTILLERY CANNONS

APPENDIX N
INTERCHANGEABILITY OF AMMUNITION

| | | |
|------|--------------------|-----|
| N-1. | GENERAL | N-1 |
| N-2. | TRAINING | N-1 |
| N-3. | COMBAT | N-1 |

APPENDIX O
SAMPLE TESTS AND REPORTS

| | | |
|-----------------------------|--|--------------|
| O-1. | SAMPLE TESTS FOR THE QUALIFICATION OF SAFETY PERSONNEL | O-1 |
| O-2. | HANDS-ON SAFETY CERTIFICATION | O-12 |
| O-3. | VERIFICATION CHECKLIST | O-21 |
| GLOSSARY | | Glossary-1 |
| REFERENCES | | References-1 |
| INDEX | | Index-1 |

FM 6-50/MCWP 3-1.6.23
23 DECEMBER 1996

By Order of the Secretary of the Army:

Official:

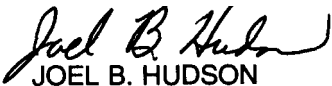
JOEL B. HUDSON
*Administrative Assistant to the
Secretary of the Army*
02743

DENNIS J. REIMER
*General, United States Army
Chief of Staff*

BY DIRECTION OF THE COMMANDANT OF THE MARINE CORPS

PAUL K. VAN RIPER
Lieutenant General, U.S. Marine Corps
Commanding General
Marine Corps Combat Development Command
Quantico, Virginia

DISTRIBUTION:

Active Army, Army National Guard, and U.S. Army Reserve: To be distributed in accordance with the initial distribution number 110776, requirements for FM 6-50.

CHAPTER 1

MISSION, ORGANIZATION, AND KEY PERSONNEL

Section I

MISSION AND GENERAL ORGANIZATION

1-1. MISSION

a. The mission of the field artillery (FA) is to destroy, neutralize, or suppress the enemy by cannon, rocket, and missile fires and to help integrate all fire support assets into combined arms operations.

b. The field artillery cannon battery is the basic firing element of the cannon battalion regardless of how the battery is organized. The battery's capability is enhanced through the flexibility and survivability provided under an organization based on platoons. In no way should the references to platoon- or battery-based organizations be construed as the structure for operational employment. Rather, the terms pertain solely to organizational structure.

Note: For tactics, techniques, and procedures for the M109A6 (Paladin), see FM 6-50-60.

1-2. FIELD ARTILLERY ORGANIZATION

The field artillery is organized into light, medium, and heavy artillery on the basis of weapon caliber.

a. Each light artillery (105-mm M102, M101A1, or M119A1) battery has a headquarters section and six howitzer sections.

b. Each medium (155-mm M109A2-A6 and M198) battery is organized in one of two ways:

(1) A platoon-based unit has a headquarters and two firing platoons of three or four howitzer sections each. This organization allows for platoon operations.

Note: The M109A5 howitzer battery organic to the regimental armored cavalry squadron is designed to function independently and to perform most of its own support functions. It is organized, trained, and equipped to operate in direct support of the squadron.

(2) A battery-based unit has a headquarters section and six howitzer sections.

c. Organization does affect employment. In a unit organized with a single six-gun battery, the battery is employed as a single unit under the direct control of the battery commander. In a platoon-based unit, the battery may be employed in one of the following ways:

- As two platoons under the control of the battery commander (BC).
- As a single unit, with the platoons merged.
- As two separate platoons directly controlled by the battalion S3, through the BC, with the battery commander providing reconnaissance, selection, and occupation of position (RSOP) and logistical support.

This last employment option is the least desirable. It is used only when the tactical situation permits no other means of command and control.

Note: AH battalions in the US Marine Corps are organized into three six-howitzer batteries.

1-3. COMMAND AND CONTROL OF BATTERIES

a. The FA cannon battalion issues movement instructions and other orders to the battery, regardless of whether the battery is battery- or platoon-based. Orders are issued to the battery commander or his operations center. These orders specify the artillery requirements of the fire support coordinator (FSCOORD) rather than trying to specify how the commander is to accomplish the mission. The BC selects platoon positions within the larger battery area selected by the S3. The battery commander will also determine which platoon is better able to move at any given time. The functions of the FA battalion tactical operations center (TOC) are to position and control the fires of the batteries. The BC positions and controls the fires of his platoons. The battalion TOC should be involved with directly controlling platoons only when no other option is available.

b. In a battery-based (3x6) unit, command and control of the firing battery is facilitated through the battery commander and the battery operations center (BOC). The battery fire direction center (FDC) controls the firing of the battery and is required to maintain the current tactical situation and respond to the supported unit and higher headquarters. The BOC serves as a focal point for internal battery operations to include command and control, battery defense, coordinating logistics, and all other operational functions normally performed by a headquarters. It also serves as the alternate FDC by providing backup fire direction capability with the lightweight computer unit (LCU) or manual gunnery techniques.

c. In a platoon-based (3 x 6 or 3 x 8) battery, the requirement for functional command and control exists at both platoon and battery levels. In the platoon, this requirement is met by the platoon operations center (POC). The POC is nothing more than the FDC with added operational responsibilities. The POC is not a separate element and does not require a separate vehicle. Its functions are supervised by the fire direction officer (FDO). Two of the functions of the POC are technical and tactical fire direction, the traditional functions of the FDC. Additional functions of the POC are reporting, accepting and executing orders from higher headquarters, coordinating logistics, and all the other operational functions normally performed by a headquarters.

d. The BC of the platoon-based battery must also provide for a single point for command and control of the battery. Because the battery does not have the personnel or equipment to establish a separate BOC, the BC does this by designating an element within the firing battery, normally one of the POCs, to perform the battery operations function. In addition to its functions described above, the designated POC handles all tactical and logistical information and personnel and maintenance reports for the battery as a whole. One of the POCs should be designated as the casualty collection point for the battery and the medic is located with this POC. This POC may require augmentation to perform this function. The battery NBC noncommissioned officer (NCO) can provide this augmentation. By augmenting the POC in this manner, the NBC NCO also enhances his ability to perform his own monitoring and reporting functions.

Note: This manual will refer to the designated POC as a BOC to indicate that it is performing the BOC functions of a battery-based unit.

e. In a platoon-based firing battery, the location of the BOC and the battery trains must facilitate command, control and logistical support of the battery. There are three basic options

for positioning the battery elements. The options can be termed heavy-heavy, heavy-light, and light-light.

(1) Heavy-Heavy. This option divides the support elements in half and assigns them to each platoon. These elements should be dispersed in positions to the rear of the platoon position area to enhance survivability. Yet, they should be near the POC to facilitate coordination within the platoon.

(a) The advantages of this option are:

- Local security of both platoons is enhanced.
- Responsiveness of support elements to platoon is enhanced.

(b) The disadvantages are:

- More elements give a larger visual signature.
- Tracked and wheeled vehicles and thick- and thin-skinned vehicles are combined.

(2) Heavy-Light. This option positions all of the support elements in one platoon position area. These elements should locate near the FDC on the extremity of the position area.

(a) The advantages of this option are:

- Local security of one platoon is enhanced.
- Support is responsive to one platoon.

(b) The disadvantages are:

- One platoon has a larger visual signature.
- Maneuverability may be limited in one platoon area.
- Logistic support to the light platoon is decreased.

(3) Light-Light. This option positions all of the battery support elements in a separate location away from both platoon areas.

(a) The advantages of this option are:

- Each battery element has the smallest visual signature.
- Howitzer positioning and movement flexibility are maximized.

(b) The disadvantages are:

- Local security of platoons and battery elements is reduced.
- Combat service support (CSS) responsiveness is reduced.

Section II

CANNON BATTERIES IN PLATOON-BASED FIELD ARTILLERY BATTALIONS

1-4. ORGANIZATION

a. An FA battalion with FA batteries organized into two firing platoons for platoon operations is considered a platoon-based organization.

b. Each cannon battery in a platoon-based FA battalion consists of a battery headquarters and two firing platoons (Figure 1-1). This configuration allows for conduct of platoon operations.

(1) The battery headquarters has the personnel and equipment to perform administration, supply,

communications, NBC, and maintenance functions.

Note: Supply and NBC operations at the battery level are functions performed by personnel of the battery headquarters. There are not sections organized specifically for those functions.

(2) Each firing platoon has the personnel and equipment to determine firing data, to fire the howitzers, and to resupply ammunition. (In some units, ammunition assets may be consolidated at battalion.)

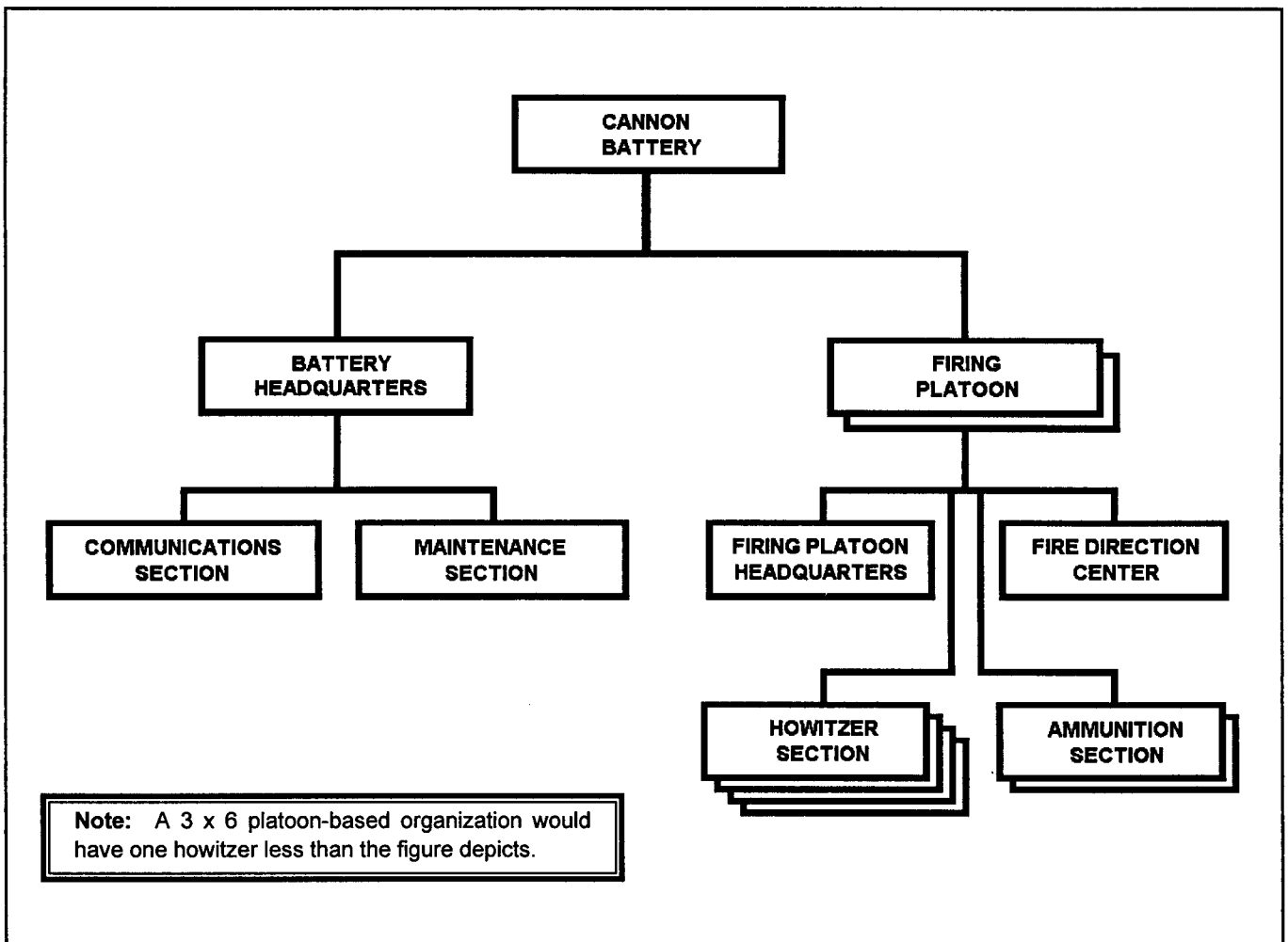

Figure 1-1. Platoon-based FA cannon battery.

1-5. TACTICAL DUTIES OF KEY PERSONNEL

Paragraphs 1-6 through 1-12 present the suggested duties of key personnel in a cannon battery of a platoon-based battalion. The unit MTOE, the commander's preference, personnel strength, and individual capabilities may require the commander to modify or reassign duties based on METT-T and standing operating procedures (SOPs).

1-6. BATTERY COMMANDER

The battery commander is responsible for all aspects of the operations of his battery. He locates where he can best command the battery, considering the factors of METT-T and the level of unit training. His responsibilities may include the following:

- a. Supervise and standardize the operations of the platoons.
- b. Reconnoiter and select platoon position areas after receiving direction from the controlling headquarters (Chapter 2).
- c. Determine the azimuth of fire if it is not given by higher headquarters.
- d. Plan and direct unit marches and movements in accordance with tactical plans established by higher headquarters (Chapter 2).
- e. Plan for survey control and, when necessary, conduct hasty survey (Chapter 5).
- f. Ensure an effective defense posture is maintained in the platoon areas (Chapter 3).
- g. Maintain communications and electronics security (Chapter 9).
- h. Plan for ammunition resupply (Chapter 12).
- i. Plan for logistic resupply of food service, supply, and maintenance items (Chapter 12).
- j. Keep the battalion TOC and battery personnel informed.
- k. Develop and execute the overall battery defense plan (Chapter 3).
- l. Supervise safety during battery operations and conduct risk assessment.
- m. Develop the battery standing operating procedure.

1-7. FIRST SERGEANT

The first sergeant (1SG) is the principal enlisted advisor to the battery commander. His responsibilities may include the following:

- a. Supervise the platoon sergeants, gunnery sergeants, and section chiefs; and, whenever possible, maintain a presence on the gun line.
- b. Assist and advise during reconnaissance and selection of platoon position areas.
- c. Assist the commander in the development and execution of the overall battery defense plan (Chapter 3).
- d. Coordinate administrative and logistical support (less ammunition), to include water and food service, mail, laundry, showers, maintenance, and evacuation of personnel and equipment (Chapter 12).
- e. Monitor the health care, welfare, and sanitation of battery personnel.
- f. Plan, coordinate, and execute the evacuation of casualties to the battalion aid station.

1-8. PLATOON LEADER

The platoon leader (PL) is responsible for everything his platoon does or fails to do. He positions himself where he can best lead the platoon, considering the factors of METT-T. He relies heavily on the platoon sergeant to supervise the firing element and on the gunnery sergeant to supervise the detailed platoon RSOP. His responsibilities may include the following:

- a. Establish and maintain the firing capability of the platoon.
- b. Supervise the displacement, movement, and occupation of the platoon.
- c. Supervise the POC, and be prepared to perform the duties of the FDO to facilitate 24-hour operations.
- d. Supervise the use of the M90 radar chronograph.
- e. Supervise the overall maintenance of platoon equipment.
- f. Ensure continuous security of the platoon (with emphasis during displacement and occupation of position).
- g. Verify minimum (rein) quadrant elevation (QE) for each howitzer.
- h. Ensure the weapon location data are submitted and updated (on DA Form 5698-R [Weapon Location Data]) and DA Form 5969-R (Section Chief's Report) is submitted to the POC.

Note: Reproducible copies of DA Forms 5698-R and 5969-R are at the back of this manual.

- i. Supervise and conduct hasty survey operations for the platoon.
- j. Supervise ammunition management within the platoon.
- k. Supervise safety during platoon operations.
- l. Ensure all reports (personnel, supply, maintenance) are submitted to the battery commander and battalion.

1-9. FIRE DIRECTION OFFICER

The FDO is responsible for the training and supervision of POC personnel. He also must be familiar with the duties of the platoon leader, as he will at times perform his duties also. His responsibilities may include the following:

- a. Decide to attack a target, and issue a fire order.
- b. Ensure accurate and timely determination of firing data.
- c. Ensure that maintenance checks are performed on the section vehicle, radios, computer, and generators in strict compliance with technical manuals.
- d. Ensure that the tactical situation map is current.
- e. Ensure accurate FDC records of missions fired are maintained.
- f. Ensure that data for prearranged fires are disseminated and understood.
- g. Ensure data from the other platoon is recorded and available.
- h. Supervise assumption of control of the fires of the other platoon when necessary.
- i. Perform independent safety computations, and verify the data with the platoon leader.
- j. Maintain muzzle velocity (MV) information for all howitzers.

1-10. PLATOON SERGEANT

The platoon sergeant (PSG) is the primary enlisted assistant to the platoon leader and must be prepared to assume all of the platoon leader's duties. His responsibilities may include the following:

- a. Supervise the firing platoon, and maintain firing capability.
- b. Supervise occupation of the position.
- c. Supervise the overall maintenance of the firing platoon.
- d. Develop and execute the platoon defense plan (Chapter 3).

- e. Provide the 1SG with the platoon defense plan for integration into the overall battery defense scheme.
- f. Ensure that each chief of section knows the route to both alternate and supplementary positions.
- g. Verify the completion of DA Form 2408-4 (Weapon Record Data).
- h. Ensure ammunition is properly handled and protected.
- i. Ensure safety aids are used and safety procedures are followed.

1-11. GUNNERY SERGEANT

The gunnery sergeant (GSG) supervises and executes platoon advance party operations (Chapter 2). He must be prepared to assume the duties of the platoon sergeant. His responsibilities may include the following:

- a. Lay the platoon.
- b. Perform hasty survey as required.
- c. Initiate the development of the platoon defense plan.
- d. Assist in the sustainment of 24-hour operations.
- e. Ensure there is an initial fire direction capability with the advance party.
- f. Compute executive officer's (XO's) min QE for the lowest preferred charge the unit expects to fire.

1-12. HOWITZER SECTION CHIEF

The section chief is responsible for the training and proficiency of his section, the operational readiness of his equipment, and the safe firing of the howitzer. Appendix B presents sample tests to help in training the gunners. The section chief's responsibilities may include the following:

- a. Ensure the weapon is properly emplaced, laid, and prepared for action. The memory aid TLABSPAP will be used as a guide for the accomplishment of the following tasks:
 - T: Trails, spades, and/or firing platform properly emplaced.
 - L: Lay weapon.
 - A: Aiming point emplaced.
 - B: Boresight verified or performed.
 - S: Second circle. Verification of lay performed with a second aiming circle.
 - P: Prefire checks on the weapon system performed.

- A: Ammunition prepared.
- P: Position improvement (site to crest determined, XO's report rendered, alternate aiming points established, azimuth markers emplaced, camouflage, and defensive hardening of position).

Note: Unit SOP and the weapon technical manual will dictate when to dig in spades on towed weapons.

- b. Ensure digital and voice communications with FDC are established and maintained.
- c. Ensure ammunition is properly segregated, stored, handled, and prepared.
- d. Ensure only safe data is fired by verifying firing data, correct sight picture, and bubbles centered.
- e. Ensure DA Form 4513 (Record of Missions Fired) is current, legible, and accurate (Chapter 7).

f. Maintain DA Form 2408-4, and compute and record equivalent full charge (EFC) data.

g. Ensure DA Form 5969-R is completed for each position occupied.

h. Ensure data on DA Form 5212-R (Gunner's Reference Card) are correct and current.

Note: A reproducible copy of DA Form 5212-R is at the back of this manual.

i. Ensure range cards for the howitzer and crew-served weapons are properly prepared, and actively manage the assigned sector of the platoon defense plan.

j. Ensure preventive maintenance checks and services (PMCS) are performed in accordance with the appropriate technical manual.

Section III

CANNON BATTERIES IN BATTERY-BASED FIELD ARTILLERY BATTALIONS

1-13. ORGANIZATION

a. A cannon battery in a battalion consisting of a headquarters battery, a service battery, and firing batteries (without TOE-designated platoons) is considered a battery-based battery.

b. Each cannon battery in a battery-based FA battalion consists of a battery headquarters and a firing battery (Figure 1-2).

(1) The battery headquarters has the personnel and equipment to perform food service, supply, communications, NBC, and maintenance functions. (In some units, food service and maintenance may be consolidated at battalion.)

(2) The firing battery has the personnel and equipment to determine firing data, fire the howitzers, and resupply ammunition. (In some units, ammunition assets may be consolidated at battalion.)

1-14. TACTICAL DUTIES OF KEY PERSONNEL

Paragraphs 1-15 through 1-22 present recommended duties of key personnel in a cannon battery of a battery-based

battalion. The unit MTOE, personnel fills, and individual capabilities may require the commander to modify or reassign duties to fit his circumstances and SOPs.

Note: Key personnel in a US Marine Corps (USMC) battery have the same duties and responsibilities, except where noted.

1-15. BATTERY COMMANDER

The battery commander is responsible for all aspects of the operations of his battery. He must plan and train for continuous operations in an intense combat environment. He locates where he can best command the battery, considering the factors of METT-T and the level of unit training. His responsibilities may include the following:

- a. Supervise and standardize the operations of the battery.
- b. Reconnoiter and select battery positions (Chapter 2).
- c. Supervise the FDC when necessary.

- d. Plan specific actions to enhance the survivability of the battery (Chapter 3).
- e. Plan for survey control; and, when necessary, perform hasty survey (Chapter 5).
- f. Plan unit marches and movements (Chapter 2).
- g. Plan the basic load mix and the resupply actions for the battery.
- h. Plan logistics for the battery supply, mess, and maintenance (Chapter 12).
- i. Establish and maintain communications and electronics security (Chapter 9).
- j. Keep the battalion TOC and battery personnel informed.
- k. Develop and execute the overall battery defense plan (Chapter 3).
- l. Supervise safety during battery operations and conduct risk assessment.
- m. Develop the battery standing operating procedure.

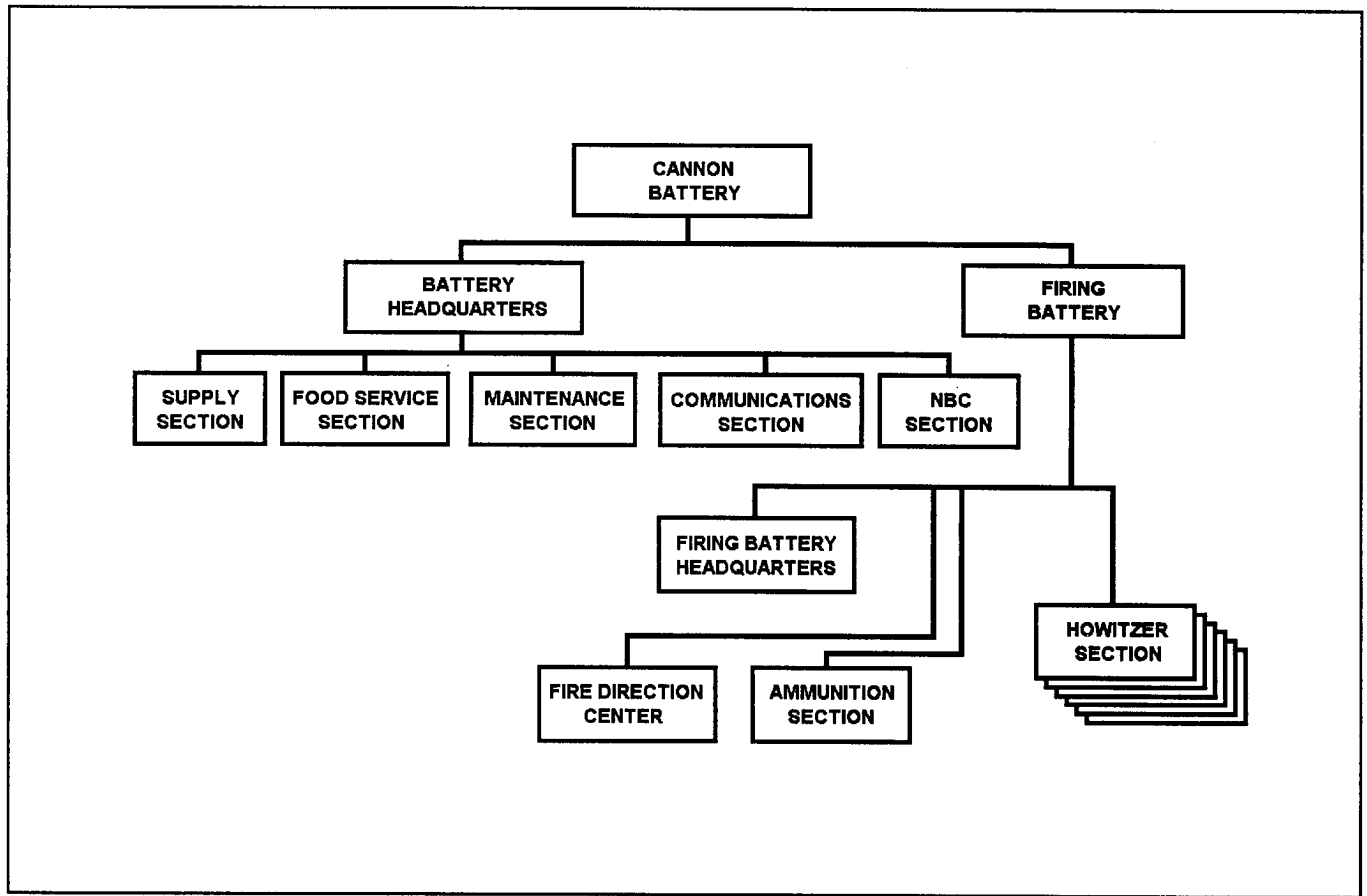

Figure 1-2. Battery-based cannon battery.

1-16. FIRST SERGEANT

The 1SG is the principal enlisted advisor to the battery commander. His responsibilities may include the following:

- a. Supervise the chief of firing battery and gunnery sergeant; and, whenever possible, maintain a presence on the gun line.
- b. Assist and advise the BC during reconnaissance and selection of the battery position.
- c. Assist the battery commander in the development and execution of the overall battery defense Plan (Chapter 3).

Note: In a USMC battery, the local security chief plans and executes overall battery defense.

- d. Coordinate administrative and logistical support (less ammunition), to include water and food service, mail, laundry, showers, maintenance, and evacuation of personnel and equipment (Chapter 12).
- e. Supervise the health care, welfare, and sanitation of battery personnel.
- f. Plan, coordinate, and execute the evacuation of casualties to the battalion aid station.

1-17. EXECUTIVE OFFICER

Usually, the XO commands the firing battery portion of the battery. As the position commander, he is responsible for everything the firing battery does or fails to do. During extended field operations, he spends part of his time supervising technical operations of the FDC. During this time, he relies heavily on the chief of firing battery to supervise the battery. Also, he relies on the GSG to lead the advance party. The XO's responsibilities may include the following:

- a. Establish and maintain the firing capability of the battery.
- b. Supervise the displacement, movement and occupation of the battery.
- c. Supervise the use of the radar chronograph and overall MV management program of the battery.
- d. Supervise the maintenance of the battery equipment.
- e. Ensure continuous security of the battery (with emphasis during displacement and occupation of position).
- f. Verify minimum QE for each howitzer.
- g. Ensure that the weapon location data report is submitted and updated and that the section chiefs reports are submitted to the FDC.
- h. Supervise and conduct hasty survey operations for the battery.

- i. Supervise the ammunition management for the battery.
- j. Supervise safety during battery operations.

1-18. ASSISTANT EXECUTIVE OFFICER (USMC only)

The assistant executive officer (AXO) assists the XO and FDO. He leads the BOC and assists the battery commander during displacement. His responsibilities include the following:

- a. Lay the battery.
- b. Perform hasty survey as required.
- c. Assume the duties of XO or FDO, when required.
- d. Assist in the establishment and maintenance of battery firing capability during advance party operations.
- e. Coordinate resupply and distribution of ammunition with the FDO.
- f. Perform liaison with battalion and other outside agencies, as required.
- g. Ensure there is initial fire direction capability with the advance party.
- h. Compute the XO's min QE for the lowest preferred charge the unit expects to fire.

1-19. FIRE DIRECTION OFFICER

The fire direction officer is responsible for the training and supervision of the FDC personnel. He also must be familiar with the duties of the XO; since he will, at times, perform all those duties. His responsibilities may include the following:

- a. Decide to attack a target, and issue a fire order.
- b. Ensure accurate and timely determination of firing data.
- c. Ensure that maintenance checks are performed on the section vehicle, radios, computer, and generators in strict compliance with the technical manuals.
- d. Ensure that the tactical situation map is current.
- e. Ensure accurate FDC records of missions fired are maintained.
- f. Ensure that data for prearranged fires is disseminated and understood.
- g. Ensure data from the other batteries are recorded and available.
- h. Supervise assumption of control of the fires of other units when necessary.

- i. Perform independent safety computations, and verify the data with the executive officer.
- j. Maintain muzzle velocity information for all howitzers.

1-20. CHIEF OF FIRING BATTERY

The chief of firing battery (CFB) is the primary enlisted advisor to the XO and must be prepared to assume all of the XO's duties. The equivalent USMC billet description is the battery gunnery sergeant (Btry GySgt). His responsibilities may include the following:

- a. Supervise and maintain the firing capability of the battery.
- b. Supervise the occupation of the position.
- c. Supervise the overall maintenance of the firing battery.
- d. Continue to develop and implement the battery defense plan.
- e. Give the 1SG information on the defense plan.
- f. Ensure that each chief of section knows the route to both alternate and supplementary positions.
- g. Verify the completion of the DA Form 2408-4.
- h. Ensure ammunition is properly handled and protected.
- i. Ensure safety aids and procedures are maintained.
- j. In a USMC battery, the battery gunnery sergeant will complete the NAVMC 10558A (gun book) and compute and record EFC data.

1-21. GUNNERY SERGEANT

The gunnery sergeant supervises and executes the battery advance party operations (Chapter 2). The equivalent USMC billet description is the local security chief. He must be prepared to assume the duties of the chief of firing battery or battery gunnery sergeant. Additional responsibilities may include the following:

- a. Lay the battery.
- b. Perform hasty survey as required.
- c. Initiate the development of the battery defense plan when necessary.
- d. Assist in the sustainment of 24 hour-operations.
- e. Ensure there is an initial fire direction capability with the advance party.

f. Compute the XO's min QE for the lowest preferred charge the unit expects to fire.

g. In a USMC battery, the local security chief plans and executes overall battery defense. The AXO lays the battery, performs hasty survey as required, ensures an initial fire direction capability with the advance party, and computes the XO min QE for the lowest preferred charge the unit expects to fire.

1-22. HOWITZER SECTION CHIEF

The section chief is responsible for the training and proficiency of his section, the operational readiness of his equipment, and the safe firing of his weapon. His responsibilities may include the following:

- a. Ensure the weapon is properly emplaced, laid, and prepared for action. The memory aid TLABSPAP will be used as a guide for accomplishment of the following tasks:
 - T: T rails, spades, and/or firing platform emplaced.
 - L: L ay the weapon.
 - A: A iming point emplaced.
 - B: B oresight verified or performed.
 - S: S econd circle. Verification of lay performed with a second aiming circle.
 - P: P refire checks in accordance with operator's manual
 - A: A mmunition prepared.
 - P: P osition improvement (site to crest determined, XO's report rendered, alternate aiming points established, azimuth markers emplaced, camouflage, and defensive hardening of position).

Note: Unit SOP and the weapon technical manual will dictate when to dig in spades on towed weapons.

- b. Ensure digital and voice communications with FDC are established and maintained.
- c. Ensure ammunition is properly segregated, stored, handled, and prepared.
- d. Ensure only safe data is fired by verify firing data, correct sight picture, and bubbles centered.
- e. Ensure DA Form 4513 is current, legible, and accurate (Chapter 7).

FM 6-50, MCWP 3-1.6.23

f. Maintain the DA Form 2408-4, and compute and record EFC data. In a USMC batter, the battery gunnery sergeant will complete the NAVMC 10558A, and compute and record EFC data.

g. Ensure DA Form 5969-R is completed for each position occupied.

h. Ensure data are correct and current on DA Form 5212-R.

i. Ensure range cards for the howitzer and crew-served weapons are properly prepared, and actively manage assigned sector of the defense plan.

j. Ensure PMCS are performed in accordance with the appropriate technical manual.

CHAPTER 2
**RECONNAISSANCE, SELECTION, AND
OCCUPATION OF A POSITION**

This Chapter Implements STANAG 2041, QSTAG 520 and STANAG 2154/QSTAG 539.

Section I
RECONNAISSANCE AND THE ADVANCE PARTY

2-1. DEFINITION AND REQUIREMENTS

Reconnaissance, selection and occupation of position ensures the rapid and orderly movement to and occupation of a firing position. On the battlefield, a sophisticated enemy can locate and engage a battery in various ways. To survive, we may have to move often. Frequent movement, however, reduces responsiveness; it necessitates greater reliance on other batteries to assume the mission during displacement. To minimize movement time, all key personnel must be able to do the reconnaissance, selection, organization, occupation, and movement tasks quickly and efficiently. The key to a successful RSOP is discipline and team effort. Reconnaissance is the examination of the terrain to determine its suitability for use in accomplishing the mission.

2-2. CONSIDERATIONS

A continuous and aggressive reconnaissance is essential to timely and accurate fire support. The BC or his representative must continually perform this reconnaissance and plan ahead to meet any contingency. The BC must have a clear understanding of the tactical situation, of both friendly and enemy forces, while planning and executing any movement. The headquarters controlling the movement of the battery directs the essential elements of the movement—when, where, and how. The BC will advise the controlling headquarters of any factors to be considered in determining the essential elements of the move.

2-3. RECEIPT OF THE ORDER

The battery commander may receive movement orders ranging from a five-paragraph operation order (OPORD) to a simple authenticated radio message. A movement order from higher headquarters should include the general location of the new position, the azimuth of fire, no earlier than (NET) time the unit can cease firing capability, no later than (NLT) time to be in position ready to fire, route (if applicable), and any specific instructions (danger areas, intelligence, alternate positions, movement techniques). Unit

SOP should determine which, if any, of the above items are delegated to the battery commander.

2-4. ARTILLERY TROOP LEADING PROCEDURES

Troop leading procedures (TLPs) provide a mental framework to ensure complete preparation, dissemination and execution of the battery mission. The process provides a checklist for the commander from receipt of the mission to execution. The steps may occur out of order or simultaneously after receipt of the mission.

a. Receive the Mission. Upon receipt of the FA support plan (FASP) or a warning order, the commander must analyze the mission in order to identify critical fire support tasks. He defines the task, purpose, method and success for each task to determine specific ammunition, logistics and unit preparation requirements. He should identify the precombat checks (PCCs) in priority that the sections must accomplish. A battery SOP should have PCCs that support routine tasks. These checklists streamline mission preparation. Finally, the commander needs to set a timeline for all critical events from issuing the warning order to execution.

b. Issue the Warning Order. The commander takes his battery mission, critical fire support tasks, PCC priorities and timeline and issues a warning order to maximize battery preparation time. Even incomplete information can allow the sections to accomplish most of their required preparations. A modified five paragraph order works well.

c. Make a Tentative Plan. The commander must gather information to make his plan by focusing on battery level METT-T and intelligence preparation of the battlefield (IPB), if available. The commander is concerned with positioning, movement, logistic support, rehearsals and defense as he makes his plan.

d. Initiate Movement. If the mission requires repositioning, the commander should start his battery

movement as early as possible (in accordance with METT-T) to make use of available time.

e. Conduct Reconnaissance. Depending on METT-T, the reconnaissance may be a simple map reconnaissance. Ideally, it will consist of ground reconnaissance, establishing and verifying survey control, fully preparing the position to receive the battery, and developing the battery defense. Coordination for survey, engineer support, route security, adjacent unit coordination, and fire support can be accomplished.

f. Complete the Plan. The commander must organize the information into a coherent order to issue to his sections. The level of detail is METT-T dependent, but as a minimum must convey the essential information to accomplish the critical fire support tasks. Prepare a terrain sketch or map board to use to issue the order. Rehearse to ensure a focused and clear delivery.

g. Issue the Order. Key players must be present for the brief. Headquarters and BOC personnel should attend so they understand their role. Be concise, but specific in the subunit missions to each section. Once complete, use backbrief techniques to make sure your orders and priorities are understood. Have the XO and other key leaders back brief you after they have had time to analyze and implement their part of the plan. State the specific items you will check or have another leader check. Update your time line and rehearsal schedule.

h. Supervise. This is the most important step. Leaders must conduct precombat inspections (PCIs) and spot-check the plan to ensure standards are met. In the defense especially, leaders must ensure weapons range cards, fighting positions, observation posts, and knowledge are to standard. Use subordinate leaders to assist, but the commander must conduct the priority PCIs. The requirements for effective PCIs are outlined in FM 7-123, pages 2-33 to 2-35.

Note: Appendix C of this manual provides a sample battery field artillery support plan checklist, sample precombat checklists, a sample warning order, a mission analysis work sheet, and a sample battery operations order.

2-5. RSOP OPERATIONS

The BC is responsible for the overall RSOP. He or his representative performs general reconnaissance and leads the advance party. He selects a battery or two firing platoon positions and a battery trains position (if applicable). The gunnery sergeants will then conduct the detailed RSOPs for their locations.

2-6. METHODS OF RECONNAISSANCE

The three methods by which the battery commander and platoon leaders may conduct a reconnaissance are map, air, and ground. The best reconnaissance is one which uses a combination of all three. Normally, the commander is able only to make a map inspection, followed by a ground reconnaissance.

a. Map Reconnaissance.

(1) Any reconnaissance begins with a map inspection. Potential positions and routes to the new position can be chosen. This method is very fast and allows unsuitable routes to be eliminated. In addition, likely ambush sites can be identified on the map. The BC or platoon leader can also determine an initial order of march for the howitzers. The rule he applies here is that the howitzer which will travel the farthest into the new position will be the first vehicle in the column. There are also two major disadvantages to conducting only a map inspection:

(a) Terrain and other features may have been altered. For example, a bridge shown on the map may no longer exist. Military load classifications of bridges are not listed on maps. Bridges must be physically inspected.

(b) The surface conditions of the route and position cannot be determined. For example, the ground may not support an M109A3-A6 howitzer or an M198 howitzer and its prime mover.

(2) If available, aerial photographs should be used to supplement maps. They are usually more recent, show more detail, and present a clear picture of the current condition of the terrain to be crossed.

(3) In addition to aerial photographs, the battery commander can ask his battalion S2 or higher headquarters intelligence section for products from the *terra-base* computer program concerning his subsequent position areas and routes.

b. Air Reconnaissance. If time and resources are available, information gained from an air reconnaissance may be very beneficial in the selection of routes to be used and areas to be occupied. Although a fast method, true surface conditions may not be distinguishable or may appear distorted. The battery commander must be careful that his flight plan does not compromise the route or the new position area. Normally this method will not be available to the battery commander.

c. Ground Reconnaissance. The best method of reconnaissance is the ground reconnaissance. The suitability of routes can be physically examined. The true condition of the terrain is especially critical if the surface has been affected by enemy action (NBC attack) and/or weather

conditions. The ground reconnaissance is the slowest method.

2-7. PLANNING THE RECONNAISSANCE

To maximize the tactical benefit, the reconnaissance must be thoroughly planned. As part of the planning phase for any operation order or RSOP, the factors of METT-T **must** be considered before any action is taken.

a. Mission. The mission is the governing factor in planning the RSOP. The unit must remain able to perform its mission with minimal degradation as a result of tactical or survivability moves. The battery commander must perform, or have previously done, his mission analysis with respect to his current and subsequent positions. Then he can identify the battery's critical tasks in each of these positions, and determine a list of movement and positioning criteria.

Movement Criteria Examples:

- The battery cannot lose firing capability. Therefore, the battery must move by platoon.
- Battery is out of range to execute their portion of the fire support plan. Therefore, move by battery using fastest movement technique.
- Battalion has two batteries moving at the same time. The battery could receive an emergency mission. Therefore, the battery must consider an internal platoon order of march and perform a reconnaissance of areas along the planned route to assist the battery on meeting this contingency.

b. Enemy Situation. The current enemy situation must be thoroughly understood. The disposition, intentions, and capabilities of enemy forces must be analyzed before the RSOP, particularly their local capabilities as revealed in current combat information.

Enemy Situation Examples:

1. If the most likely enemy action during the battery's movement is from air attack, then:
 - The BC requests a change to the given route to support a terrain march for certain segments of the planned route where there is not adequate concealment for the battery.
 - The route must allow the march units to conduct their immediate action drills for air attack.
 - A route reconnaissance must be performed to determine easily identifiable features to serve as air target reference points (TRPs).

- If a terrain march is too slow, move in an open column.

2. If the most dangerous enemy action during the battery's movement is ambush, then:

- Each march element, to include the reconnaissance and advance parties, must lead with an armored vehicle and/or crew served weapon.
- Coordinate with higher headquarters to determine possible ambush sites and clear those areas so that advance parties or main bodies can conduct reconnaissance by fire.

Positioning Criteria Examples:

1. If the most likely threat in the subsequent position is enemy counter-battery fire, then the battery commander must ensure position areas support maximum dispersion and hardening.

2. If the most dangerous threat to the battery in the subsequent position is from mechanized forces, then:

- The battery commander must ensure the position is not located on platoon-sized or larger avenues of approach.
- He must perform a reconnaissance of possible observation posts (OP) to provide for early warning to execute hasty displacements or the activation of howitzer direct fire and/or tank-killer teams.
- He must make a reconnaissance of the position area for supplemental positions for howitzer direct fire and/or tank-killer teams.
- He must make a reconnaissance to determine if the position provides adequate defilade and terrain masking.

c. Terrain and Weather. The BC and/or platoon leaders must analyze the routes to be used by the unit assets and the time and distance required to make the move. The ability to move one firing platoon while keeping the other in position and firing is critical to the platoon-based operations and the accomplishment of the battery mission. Moving the battery over long, difficult routes requires well planned, coordinated movement orders and unit SOPs. The effects of the weather on the terrain to be crossed must be analyzed to facilitate rapid movement. Weather affects visibility (fog, haze) and trafficability (ice, rain-softened ground).

d. Troops. The current troop strength and level of training must be considered. The mission may not change; but the troops available to accomplish it will. As the other factors of METT-T vary, so will the number of troops necessary

to perform the mission. Because of casualties and these varying conditions, adjustments must be made during the planning phase.

e. Time. The amount of time available for the RSOP will effect all phases of its accomplishment. The time factor will change due to events on the battlefield. Whether minutes or hours are allowed for the RSOP, adjustments must be made.

2-8. THE RECONNAISSANCE PARTY

The reconnaissance party should consist of enough individuals to accomplish successful RSOP. An example of a reconnaissance party is: the commander, the GSG, and representatives from each howitzer FDC; and support section. If enough survey or position azimuth determining system (PADS) sections are available, a survey capability

should be allocated to the commander. This capability will depend upon survey priority established by the battalion S3. The commander of a firing battery chooses position areas for the platoons or the battery and determines the azimuth of fire. The GSG then performs detailed position area RSOP.

2-9. ASSEMBLING THE ADVANCE PARTY

For either a deliberate or a hasty occupation, a prearranged signal or procedure should be used to alert and assemble the advance party. The signal should be in the unit SOPs, which will also list the personnel, equipment, vehicles, and place of assembly (see Tables 2-1 and 2-2). The advance party is normally assembled no later than the prepare-to-march-order phase.

Table 2-1. Advance party equipment

| PERSONNEL | EQUIPMENT |
|--------------------------------|--|
| Battery Commander and Driver | Vehicle with radio, map, compass, binoculars, chemical detection equipment M8A1, M256 kits, M8 paper, and IM-93 and IM-174 radiac meter or radiac set AN/VDR-2, GPS if available, NVGs as needed. |
| First Sergeant | Map, grid sheet, overlay paper, coordinate scale, and protractor (The 1SG supervises mine detector operations, if applicable.) |
| Gunnery Sergeant | Vehicle with radio, map, compass, binoculars, aiming circle, TA-312, DR-8 with RL-39, and chemical detection (M8A1, M256, M8 paper) and radiac equipment (IM-93, IM174, or radiac set AN/VDR-2) as required, GPS if available, NVGs as needed. |
| POC or FDC Guide | TA-312, DR-8 with RL-39, OE-254, M17 plotting board, tabular firing tables (TFTs), subtense tables, and DA Form 5698-R. |
| Gun Guides | Compass, marking stakes with tape, TA-312, DR-8 with RL-39, hammer, and panoramic telescope marker, two flashlights with extra batteries. |
| Communications Representatives | TM-184 or MX-155, TA-312, and DR-8 with RL-39. |

Table 2-2. Primary duties of advance party personnel

| JOB | RECONNAISSANCE PHASE | SELECT AND/OR ORGANIZE PHASE | OCCUPATION PHASE |
|---------------------------|--|--|--|
| Battery Commander | Conduct map reconnaissance. Select primary and/or alternate routes and checkpoints. Determine platoon order of march. Brief platoon leaders, GSGs, and other key leaders. Conduct ground reconnaissance. | Select platoon position areas. Select azimuth of fire if not given. Direct emplacement of survey control (if survey support is available), or perform hasty survey. Select trains location if trains are not collocated with a platoon. Reconnoiter alternate and/or supplementary positions. | Supervise occupation by the platoons. |
| First Sergeant | Assist BC on reconnaissance. | Plan battery defense. Coordinate defense efforts of all battery elements. Organize trains position, and select support vehicle positions. Direct security and defense of battery. | Brief platoon sergeants on defense plan and platoon responsibilities in the plan. |
| Gunnery Sergeant | Assemble the platoon advance party. Brief the advance party. Supervise security. | Supervise the security sweep. Make plan for occupation. Designate howitzer, FDC, aiming circle, and TM-184 locations. Set up and orient the aiming circle. Determine initial deflection, distance, and vertical angle to guns. Develop track plan. Brief guides on occupation plan. Supervise preparation of position. | Lay the howitzers. Begin to prepare the platoon leader's report. |
| Gunnery Sergeant's Driver | Help in radio communications during security sweep. | Help in security sweep. Lay wire from aiming circle to TM-184, and help set up OE-254. Monitor NBC detection equipment. Position M8A1 chemical agent detector upwind of selected position if advance party brings M8A1 forward. Monitor M8A1. | Guide platoon from release point (RP) if necessary. Guide vehicles into service area if necessary. |
| POC or FDC Guide | Help in security measures. | Help in security sweep. Lay wire from TM-184 to POC or FDC position. Set up OE-254. Record initial deflection, distance, and vertical angle on updated DA Form 5698-R. Reconnoiter route from RP to section position. Compute terrain gun corrections. | Meet section at RP, and guide it to assigned position. |

Table 2-2. Primary duties of advance party personnel (continued)

| JOB | RECONNAISSANCE PHASE | SELECT AND/OR ORGANIZE PHASE | OCCUPATION PHASE |
|-------------------------------|-------------------------------------|---|---|
| Gun Guides | Help with security during movement. | Help in security sweep. Prepare section position. Lay wire from TM-184 to assigned gun position. Hold subtense bar or M16 to aid GSG in collecting TGPC information. Record initial deflection, and pass it to section chief upon occupation. Determine initial site to crest with M2 compass. Reconnoiter route from RP to section position. | Meet howitzer at RP, and guide it to assigned position. Align weapon on azimuth of fire, and give gunner initial deflection. |
| Communications Representative | Help with security during movement. | Emplace TM-184. Establish internal wire communications for transmission of firing data. Establish communication with outposts, and make wire drops to designated locations. | Meet section vehicle at RP, and guide it to assigned position (unless communications vehicle was with advance party). |

2-10. TAKING A FIRING CAPABILITY FORWARD

Depending upon the mission and tactical situation, the BC may direct that a howitzer section go forward with the advance party. Reasons for taking howitzers forward may be:

- To confuse enemy moving target locating radars, as part of the infiltration plan.
- To determine the suitability of the route and firing position when conditions are doubtful.
- To conduct a registration or an offset registration.

2-11. MOVEMENT BRIEFING

a. Before departing to reconnoiter the new position, the BC briefs the platoon leaders and other key personnel on the movement information.

- Situation:
 - Enemy situation. Rear area activity. Major avenues of approach. Air activity. Potential ambush sites.

- Friendly situation. Changes in tactical missions and locations of friendly maneuver units and supporting artillery.
- Mission: Changes in the mission of the supported maneuver unit and supporting artillery.
- Execution:
 - Concept of the operation. General location of the battery and/or platoon positions, azimuth of fire, routes, order of march, location of start point (SP) and RP and times.
 - Mission-oriented protective posture (MOPP) status.
 - Areas of known chemical and/or nuclear contamination.
- Administration and logistics: When and where to feed unit personnel, priority for maintenance recovery, ammunition resupply, and refuel location.
- Command and signal:
 - Command: Changes in location of the battalion command post (CP) and battalion support operations

center, and the location of battery commander. It also includes a contingency plan if the BC does not return or report back by a predetermined time or event.

- Signal: Movement radio frequencies and net control restrictions. Signals for immediate actions at the halt and during movement.

b. After being briefed by the BC, the platoon leader or XO briefs the remaining key personnel by using the movement order format in Figure 2-1.

2-12. ROUTE RECONNAISSANCE

a. After making a map inspection, planning the reconnaissance, and briefing the necessary personnel,

the BC is now ready to make a ground reconnaissance. Accompanied by the advance party, the BC or his representative departs on the route reconnaissance. The primary purpose of this reconnaissance is to determine the suitability of the route of the units movement. Items to be analyzed include possible alternate routes, cover, concealment, location of obstacles, likely ambush sites, contaminated areas, route marking requirements, and the time and distance required to traverse the route.

b. Once these areas are analyzed, any information considered pertinent should be sent back to the firing unit. Radio traffic must be carefully monitored to ensure that information does not compromise unit movement.

| | |
|--|--|
| <ol style="list-style-type: none"> 1. Situation: 2. Mission: 3. Execution: <ol style="list-style-type: none"> a. General. b. Organization. c. Composition of column. d. Instructions. <ol style="list-style-type: none"> (1) Air observers. (2) Reconnaissance element. (3) Route markers. (4) Start point. (5) Checkpoints. (6) Rally points. (7) Release points. (8) Route of march. (9) Alternate routes. (10) Lights. e. Unblocked ambush. f. Blocked ambush. g. Air attack. h. Artillery attack. | <ol style="list-style-type: none"> i. Hip shoots. 4. Administrative instructions: <ol style="list-style-type: none"> a. Ammunition. b. Fuel. c. Food. d. Maintenance. 5. Command and communications: <ol style="list-style-type: none"> a. XO's or platoon leader's and FDO's locations. b. CFB's or platoon sergeant's location. c. BC's location. d. Battalion or battery headquarters location. e. Other locations. f. Signals: <ol style="list-style-type: none"> (1) Unblocked ambush. (2) Blocked ambush. (3) Air attack. (4) Hip shoot. (5) NBC attack. (6) Artillery attack. (7) Radio. |
|--|--|

Figure 2-1. Movement order format

Section II

SELECTING THE NEW POSITION

2-13. POSITION SELECTION CONSIDERATIONS

The BC selects a battery position or two firing platoon position areas and the battery trains area (if needed). Once the general areas have been determined, the gunnery sergeants conduct the detailed RSOP of their respective position areas and select alternate and supplementary positions. Position selection considerations are discussed below.

a. Mission. This is the most important consideration. The position must facilitate tire throughout the maximum area of the supported maneuver force.

b. Communications. The position must facilitate communications with stations within assigned and monitored radio nets.

c. Defilade. Defilade is protection from enemy observation and direct fire weapons by use of a terrain mask. Defilade positions should be used; however they should not be so close to the mask that low-angle fire capabilities are restricted.

d. Defensibility. The position should facilitate both active and passive defense so that it:

- Can be entered without enemy observation.
- Offers effective cover and concealment, with emphasis on concealment. Also, survivability positions can also be dug by engineers to enhance both cover and concealment.
- Avoids high-speed enemy approaches.
- Has more than one entrance and exit route, preferably in the rear of the position.

e. Trafficability. Soil should be firm enough to support all vehicles.

f. Weather. The effects of weather on terrain must be considered.

g. Survey Control. Survey must be established or it must be available in a short amount of time.

2-14. TYPES OF POSITIONS

The BC or platoon leader must select primary, alternate, and supplementary positions.

a. A primary position is one from which the firing element will accomplish its assigned mission.

b. An alternate position is the one to which the unit moves in case its primary position becomes untenable. Since the unit will continue its mission from the alternate position, it must meet the same requirements as the primary position and should be far enough away to escape the effects of enemy indirect fire on the primary position. It should be reconnoitered and prepared for occupation. Each section chief must know the route to the alternate position, because movement to that position may be by section.

c. A supplementary position is one selected for accomplishment of a specific mission, such as offset registration, adjustment with a roving gun, or defense of the primary position.

(1) Supplementary position(s) for defense should be selected to cover likely enemy avenues of approach.

(2) Position(s) for offset registrations and roving guns should be far enough away so that counterfire will not affect the primary position.

Section III

ORGANIZING THE NEW POSITION

2-15. ADVANCE PARTY PREPARATIONS

a. Having arrived in the new position area, the advance party conducts a security sweep and prepares the position for occupation. The purpose of the advance party security sweep is to perform position area reconnaissance to confirm its suitability for occupation by the main body in accordance

with METT-T and the absence of enemy, mines, booby traps, NBC hazards, and so on. Natural cover must be used to the maximum. Security is continuous throughout advance party operations.

b. The advance party is not normally manned or equipped to clear areas of organized enemy activity, mines, or NBC hazards. If these threats or conditions are present in the

proposed position area, the advance party breaks contact with any enemy forces or marks minefield and hazards and moves on to find another position area. The battery commander can coordinate for additional assets, or augment the advance party with internal assets, to provide the additional ability to clear areas of small enemy forces, obstacles, and minefield.

c. The following are some tactics, techniques, procedures, and considerations units should incorporate when performing advance party security sweeps.

(1) Maximum use of the senses:

(a) *Sight*. Advance party members look for:

- Enemy personnel, vehicles, and aircraft.
- Sudden or unusual movement.
- Smoke or dust.
- Engine exhaust fumes.
- Unusual movement of farm or wild animals.
- Vehicle tracks.
- Signs or evidence of enemy occupation.
- Recently cut foliage or vegetation.
- Lights, fires, or reflections.
- Muzzle flashes.

(b) *Hearing*. Advance party members listen for:

- Running engines.
- Track sounds.
- Voices.
- Metallic sounds.
- Gunfire.
- Dismounted movement through brush or woods.

(c) *Smell*. Advance party members smell for:

- Cooking food.
- Vehicle exhaust.
- Burning petroleum products.
- Burning tobacco products.

d. Advance parties use reconnaissance methods that they have trained and rehearsed in detail. The correct reconnaissance technique will maximize security and mission accomplishment.

(1) **Mounted reconnaissance** of a position area should be used when:

- Terrain is open and provides maximum visibility.
- Time is limited.
- Very detailed reconnaissance is not required.
- Minefield and obstacles in the area are not expected.
- Enemy contact is not likely.

The advantages of a mounted reconnaissance include:

- Speed.
- The use of the advance party vehicle, depending on which type of vehicle is used (radio, GPS, possible armor protection, firepower).
- Easy to break contact and move on.

The disadvantages of a mounted reconnaissance include:

- Loss of stealth.
- Loss of some reconnaissance detail.

(2) **Dismounted reconnaissance** is used when:

- Detailed reconnaissance is required.
- Maximum stealth is necessary.
- Enemy contact is expected or likely.
- Terrain is restrictive or is surrounded by wooded areas.
- Time is not limited.
- Mines are likely in the area.

The advantages of a dismounted reconnaissance include:

- Allows the advance party to obtain detailed information about the position area.
- Less chance of enemy stay-behind forces remaining undetected.
- Allows for maximum security of the advance party.

The disadvantages of a dismounted reconnaissance include:

- Time consuming.
- Difficult to overwatch entire advance party with a crew-served weapon.
- Advance party is removed from the support of their vehicle (comm, GPS, and so on).
- More difficult to command and control.

(3) In **reconnaissance by fire**, advance parties place direct fire on positions where there is a reasonable suspicion of enemy occupation; the goal is to cause the enemy to

disclose his presence by movement or returning fire. Advance parties use this technique when enemy contact is expected and time is limited. Reconnaissance by fire does not work in all cases. For example, disciplined troops in prepared positions will not react to the advance party's fires. Some situations in which reconnaissance by fire may be employed include:

- Bunker complexes that may or may not be occupied.
- Existence of an obvious enemy kill zone.
- Signs of recent enemy activity.

Key considerations for reconnaissance by fire include:

- Indirect fire is very difficult to coordinate and requires much more time to execute and control.
- Direct fire will disclose the advance party's location.
- Requires a high degree of situational awareness to ensure that no friendly units are fired upon or return fire.

(4) Some situations might dictate a combination of mounted and dismounted reconnaissance. In any case, battery commanders and gunnery sergeants can use the following guidelines to ensure maximum security and mission accomplishment:

- Always use an element with appropriate firepower to overwatch the reconnaissance party.
- If possible, use prominent terrain to gain a vantage point to visually sweep the area with binoculars or night vision devices prior to entering.
- If dismounting, select a concealed, secure, dismount site well outside the position area.
- Develop and rehearse a contingency plan for each security sweep.

e. The following are positioned in the battery or firing platoon area:

- Howitzer locations.
- The aiming circle.
- FDC or POC.
- MX-155 or TM-184 terminal strip.
- M8A1 automatic chemical agent alarm.

f. If the battery support elements are present, they will be positioned with full consideration for survivability and operability as the tactical situation dictates. FM 6-20-1

presents information and guidance on determining positions for CSS elements.

2-16. FORMATIONS

a. The factors of METT-T must always be considered when howitzers are emplaced. The main emphasis is on mission and enemy. The artillery will most likely face a general threat of counterfire, air attack, ground attack, and radio electronic combat. To counter that threat, the BC or platoon leader must consider techniques such as dispersion, movement, hardening, and concealment when selecting positions for his howitzer.

b. The enemy counterfire threat and air attack threat may be so great that the BC or platoon leader will consider dispersing his howitzers over a large area and maximizing the natural cover and concealment offered by the local terrain. This type of howitzer positioning is called terrain gun positioning (Figure 2-2). The capabilities of the LCU and battery computer system (BCS) to compute individual piece locations have enhanced terrain gun positioning.

c. The enemy ground attack, guerrilla, and special forces threats may cause the BC to position the howitzers in a tight and defensible position area. Key personnel in the battery must consider hardening and unit defense. The diamond formation in platoon-based units (Figure 2-3) and the star formation in battery-based units (Figure 2-4, page 2-12) are optimal in these circumstances. They provide excellent 6400-mil firing and unit defense capabilities.

d. Linear formations such as the "line" and "lazy W" can best be used during situations such as emergency and hasty occupations which require immediate fire support. These formations provide an optimum standard sheaf in the target area and offer excellent command and control. However, they are vulnerable to air attack. Position improvement such as dispersion and concealment should be considered as time and the tactical situation permit.

e. The bumper number of a particular howitzer section is associated with each howitzer number (1 through 8). This association does not change from position to position. If a howitzer becomes disabled or lost en route to a new location, its associated howitzer number and all other howitzer numbers **do not change**. For example, once a weapon is designated Number 7, it remains Number 7. The LCU and BCS are initialized with individual howitzer muzzle velocity data which corresponds to a specific howitzer. Use of this procedure allows convenience in referring to pieces based on location and at the same time eliminates the requirement to vary the data base in each position. The howitzers are numbered from right to left and from front to rear when facing the azimuth of fire.

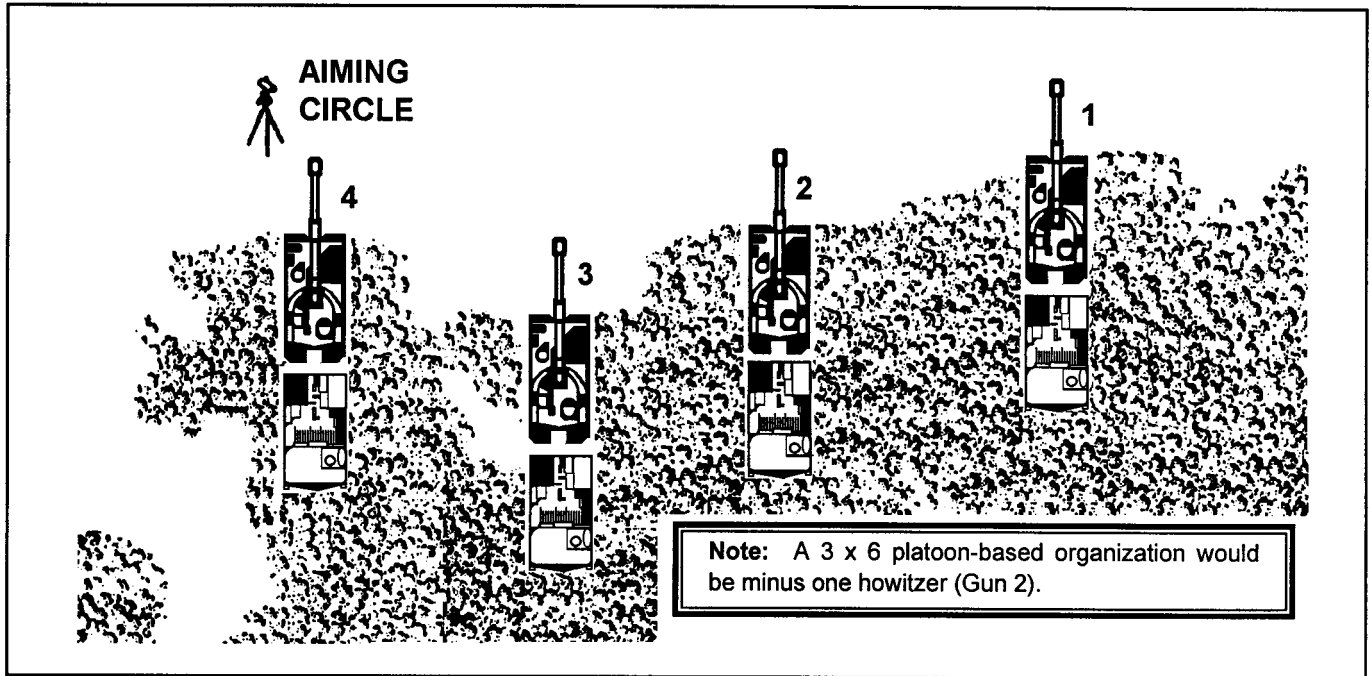

Figure 2-2. Terrain gun positioning

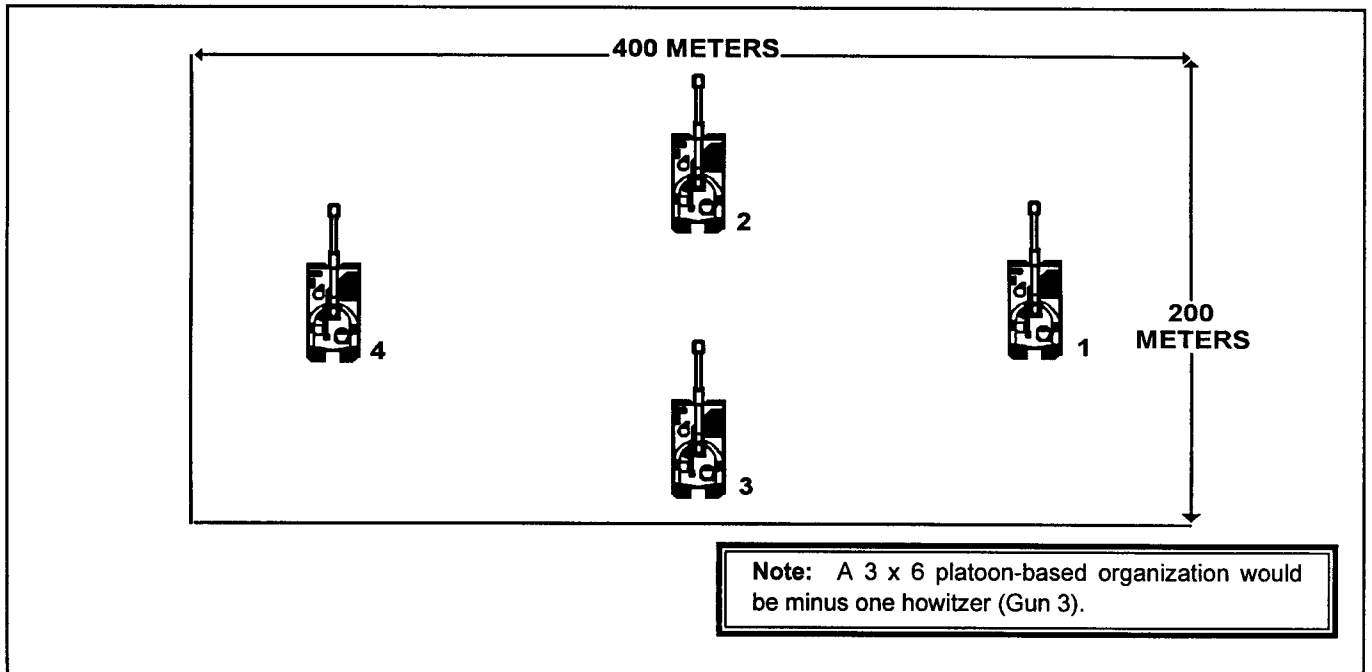

Figure 2-3. Diamond formation

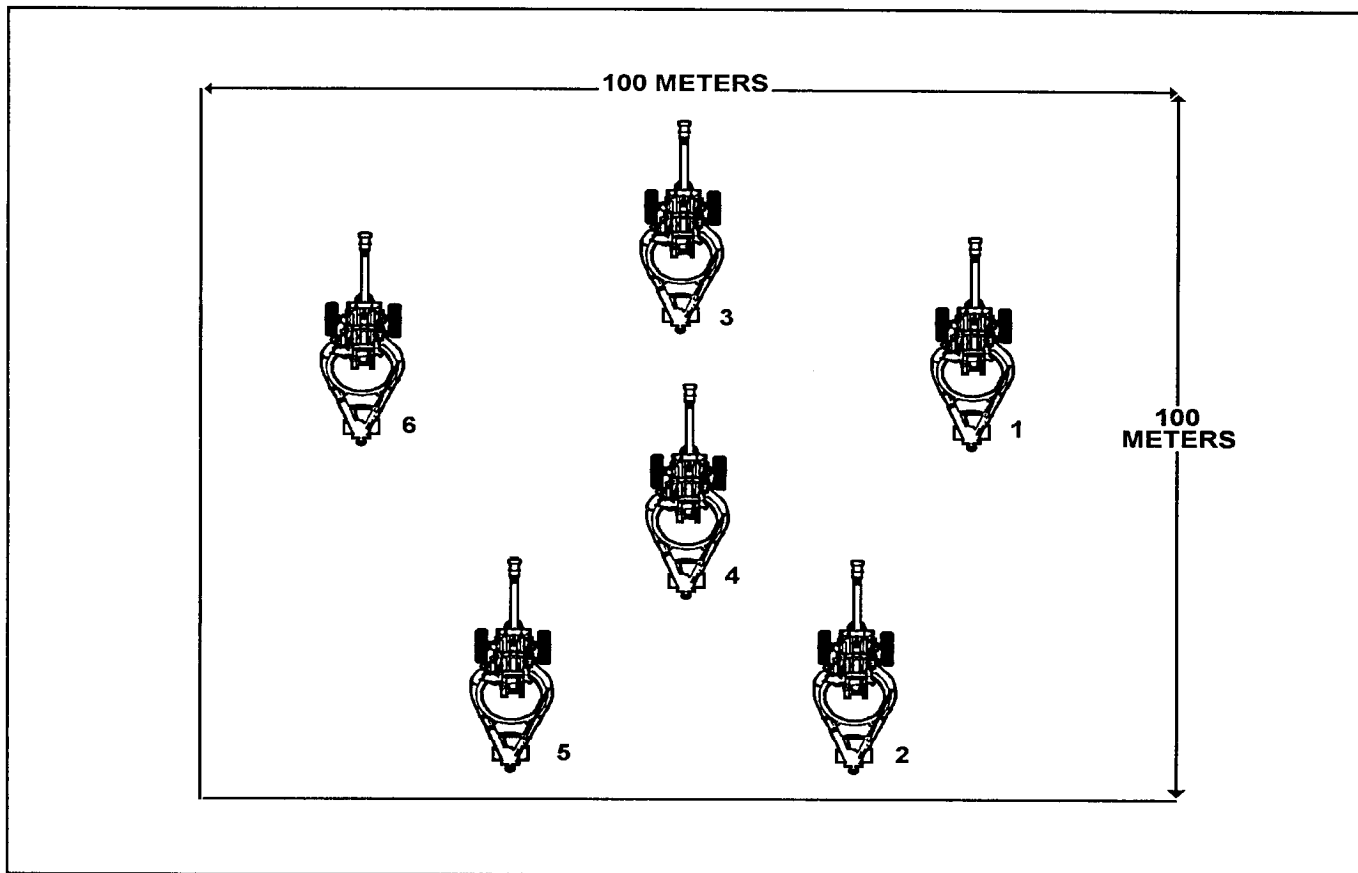

Figure 2-4. Star formation

Section IV

PREPARATION FOR OCCUPATION

2-17. DAYTIME OCCUPATION

a. The BC finalizes his plan of occupation. He gives priority to performing those tasks that facilitate immediate fire support. The plan is not limited to, but should include, the following:

- The general location for the FDC or POC and howitzer positions.
- The azimuth of fire materialized by a terrain feature or by pointing his vehicle in the direction of fire.
- Entrance and exit points and guidance to the gunnery sergeant for the track plan.
- Guidance on the scheme of defense.

- Location of the ground guide pickup point.

b. The first sergeant or gunnery sergeant establishes the track plan, organizes the vehicle dispersal area, selects a position for each element in the service area, and plans the defense of the position. Considerations are as follows:

- (1) Use existing roads.
- (2) Select separate exit and entrance routes.
- (3) Ensure routes follow natural terrain features such as gullies and tree lines and take advantage of natural overhead cover and concealment.
- (4) Brief vehicle guides on the track plan. If concealment is critical, the gunnery sergeant may dictate

the exact route of each vehicle. In SP units, sharp pivoting, which will disrupt ground cover, must be avoided.

c. The gunnery sergeant does the following:

(1) He sets up and orients the aiming circle where it will have line of sight to the howitzers. If survey is available, he directs the survey team to emplace an orienting station (ORSTA) where it will have line of sight to the howitzers and an end of orienting line (EOL) where it can be easily identified from the ORSTA. Additionally, he briefs the survey team on any marking requirements, in addition to unit SOP, necessary for the EOL. He then sets up the aiming circle over the ORSTA and verifies survey, by measuring the azimuth to the EOL (direction) and map spot/GPS (position and altitude), before releasing the survey team.

(2) As soon as the gun guides emplace panoramic telescope (pantel) marking stakes, the gunnery sergeant measures and records the initial deflection to each stake and records the azimuth (az) to the howitzer on DA Form 2698-R

(Figure 2-5). Priority is to announce the initial deflection to each gun guide over the wire line to check communications. If wire is not in, gun guides will come to the aiming circle and record the initial deflection. The gun guide gives his initial deflection to his gunner and section when the platoon arrives.

(3) He determines the distance and the vertical angle (VA) to each howitzer (see Chapter 4).

(4) Having determined the deflection, VA, and distance from the aiming circle to each weapon, the gunnery sergeant gives the data (Figure 2-5) to the FDC representative. The data are applied to the M-17 plotting board for computation of TGPCs (see Appendix D).

(5) He obtains site to crest and piece to crest range from each gun guide. He then determines XO's min QE for the lowest preferred charge the unit expects to fire in the position. Add a 20 mil safety factor to allow for the accuracy of the M2 compass.

| WEAPON LOCATION DATA | | | | | | |
|--|---------------|-------------|----------------------------------|-------------------|-----------------------|------|
| For use of this form, see FM 6-50; the proponent agency is TRADOC. | | | | | | |
| AZIMUTH OF FIRE _____ | | | | ORIENTING STATION | | |
| | | | | EASTING _____ | | |
| | | | | NORTHING _____ | | |
| | | | | ALTITUDE _____ | | |
| HOWITZER NUMBER | METHOD OF LAY | DEFLECTIONS | AZIMUTH TO HOWITZER ¹ | DISTANCE (METERS) | VERTICAL ANGLE (MILS) | GRID |
| 1 | | | | | | |
| 2 | | | | | | |
| 3 | | | | | | |
| 4 | | | SAMPLE | | | |
| 5 | | | | | | |
| 6 | | | | | | |
| 7 | | | | | | |
| 8 | | | | | | |

¹AOF + DF = AZ TO HOW
 ADD 3200 IF RED NUMBER IS USED (M12 ONLY)
 SUBTRACT 6400 IF SUM EXCEEDS 6400

DA FORM 5698-R, AUG 88

Figure 2-5. Weapons location data

d. Each gun guide does the following:

(1) He emplaces the pantel marking stake in the designated location. This stake marks the location of the pantel of the weapon.

(2) He stops the weapon parallel to the guide stake or tape so that when the weapon is emplaced, the pantel will

be over the hole left by the pantel marking stake. The proper emplacement of the pantel marking stake and guide stakes for SP units is shown in Figure 2-6 and for towed units in Figure 2-7.

(3) Lays wire from the TM-184 to his cannon position and hooks up to his TA-312 telephone.

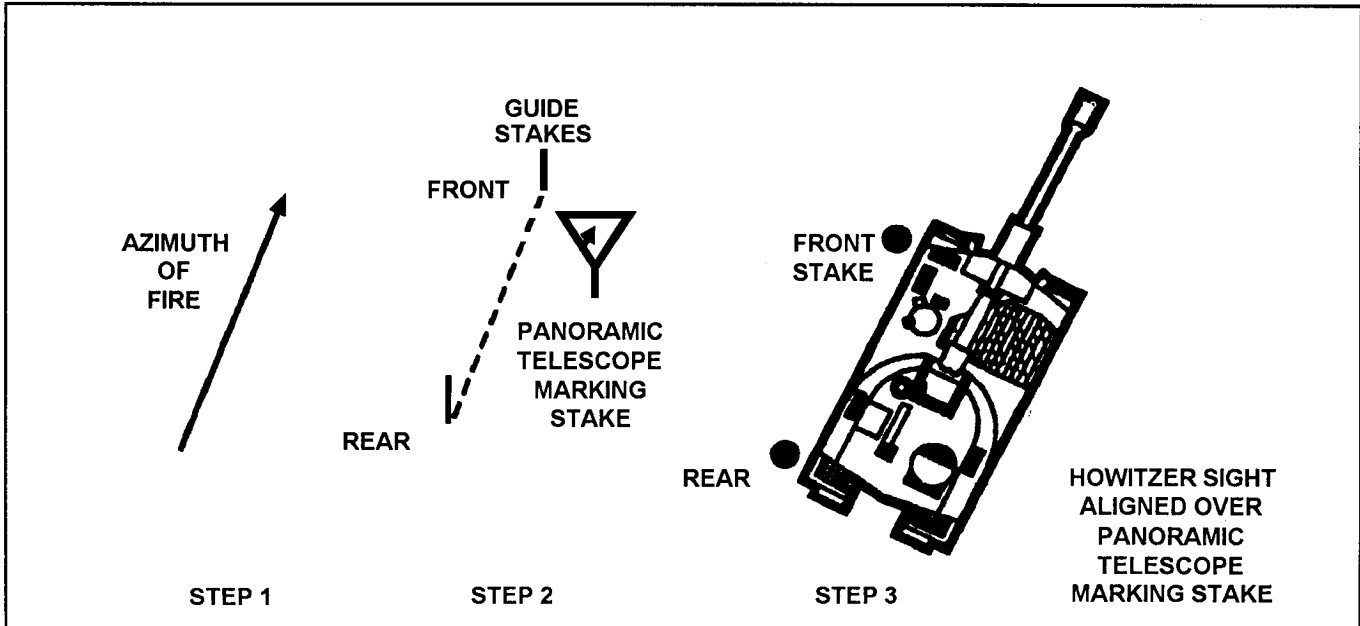

Figure 2-5. Use of stakes for self-propelled weapons

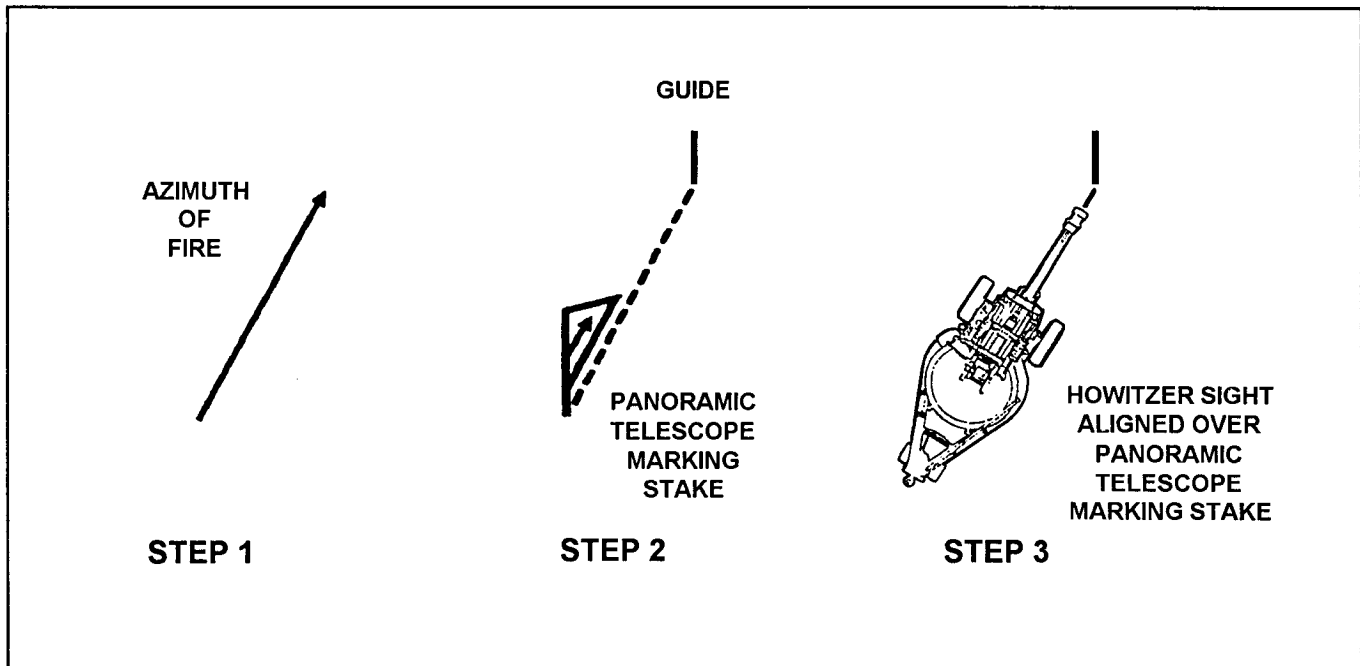

Figure 2-5. Use of stakes for towed weapons

(4) Receives and records the deflection to his pantel marking stake.

(5) He helps the GSG determine the distance from the aiming circle to his gun position. The primary means of determining distance from the aiming circle to each howitzer position is the subtense method. With this technique, the gun guide positions a 2-meter subtense bar (see Table 5-6, page 5-16) or M-16 rifle (see Table 5-7, page 5-17) over the pantel marking stake while the GSG measures the angle. If necessary, the gun guide paces the distance from his howitzer position to the aiming circle and reports the distance to the GSG. He double-checks the distance by pacing back from the aiming circle to the pantel marking stake.

(6) He determines site to crest by using the M2 compass or M2A2 aiming circle (see chapter 4). He then determines piece-to-crest range and relays site to crest and piece-to-crest range to the GSG.

(7) He walks the track plan as directed by the GSG. He walks the selected route from the battery or platoon entry point to the howitzer position and makes sure that there are no obstacles. He uses the existing roads and trails. Selected routes should follow natural terrain features, such as gullies and tree lines, and should take advantage of cover and concealment.

(8) He takes up a defensive position as directed by the GSG.

(9) He and the other gun guides assemble at the pickup point when directed by the GSG.

e. The FDC or POC representative does the following:

- Emplaces the TM-184 (when the communications representative is not present).
- Lays wire from the TM- 184 to the FDC position.
- Guides the FDC or POC vehicle into position.
- Erects the OE-254 antenna.
- Over a secure radio, relays survey and lay data to the main body.

f. The communications representative does the following:

- Emplaces the TM-184.
- Ensures that all other wire lines are laid, tagged, and properly connected to the TM-184, and lays wire to the aiming circle.
- Assists with erection of the OE-254 antenna.

Note: The communications representative's first priority is to establish internal wire communications to transmit firing data. His second priority is to establish communications with outposts and make drops at various other locations the GSG indicates.

2-18. LIMITED TIME PREPARATIONS

a. When the advance party has limited time to prepare a position, the BC or GSG must establish priority tasks. As a minimum, he must ensure the following:

- (1) Cannon positions are selected.
- (2) Aiming circle is set up.

(3) Cannon positions are prepared, to include placing of howitzer and pantel marking stakes and recording of initial deflections.

(4) Minimum essential internal wire communications are established.

(5) Attempt is made to pass survey and lay data to the main body.

b. Duties are decentralized. As soon as the BC or GSG selects the position, the gun guides select positions for their howitzers.

c. The battery commander's or GSG's driver is left at the release point to guide the entire platoon into position. Gun guides meet their vehicles as they approach their positions.

d. The FDC or POC representative and the GSG conduct their normal duties as much as time permits.

2-19. NIGHT OCCUPATION

Night occupation priorities are similar to daylight occupations. However, they require more planning, more time, and additional techniques to ensure a smooth and orderly occupation.

a. **Gunnery Sergeant.** The GSG is especially concerned with noise and light discipline, security, and communications between advance party members.

b. **Gun Guides.** Guides must be thoroughly briefed and should pace their routes before and after darkness. They should be equipped with filtered flashlights to guide the vehicles. Color coding of individual howitzer sections will facilitate section identification during night operations (example: first or fifth section-blue, second or sixth section-red, third or seventh section-yellow, and fourth or eighth section-green). Light discipline must be controlled.

2-20. SECTION CHIEF'S REPORT

a. DA Form 5969-R (samples in Figures 2-8 and 2-9) enables the platoon leader to consolidate information in preparation of his report and in his determination and verification of the minimum QE. The report should contain the following information:

- Date-time group (DTG).
- Howitzer number and bumper number.
- Azimuth of fire.
- Lay deflection (from the lay circle or other howitzer number).
- Distance from the lay circle to the howitzer.
- Site to crest (in mils).
- Distance to crest (in meters).

- Crest object (such as a tree or ridge line).
- Minimum quadrant elevation.
- Maximum quadrant elevation.
- Left and right deflection limits.
- Propellant temperature.
- Sensitive items.
- Ammunition status, which consists of projectile types, square weights, amounts, and lot numbers; fuze types and amounts; and primer types and amounts.

b. The report is required for each position area or firing point occupied. For centralized control of the report, the section chief will submit the report directly to the FDC. The position commander and FDO will take necessary actions.

| SECTION CHIEF'S REPORT | | | | | |
|---|-----------------|----------------------|-----------------|------------------------|-----------|
| (For 105-mm, 155-mm, and 203-mm Howitzers) | | | | | |
| For use of this form, see FM 6-50. The proponent agency is TRADOC. | | | | | |
| GENERAL DATA | | | | | |
| DTG | HOWITZER NUMBER | BUMPER NUMBER | AZIMUTH OF FIRE | LAY DF | METERS |
| 101420 | 7 | B-17 | 0600 | 2653 | 137 |
| SITE TO CREST | | PIECE-TO-CREST RANGE | | NATURE OF CREST | DF |
| +87 MILS | | 300 METERS | | TREE | 3513-3528 |
| SITE TO CREST | | PIECE-TO-CREST RANGE | | NATURE OF CREST | DF |
| +184 MILS | | 700 METERS | | HILL | 3072-3140 |
| SITE TO CREST | | PIECE-TO-CREST RANGE | | NATURE OF CREST | DF |
| MILS | | METERS | | | |
| MIN QE | MAX QE | LEFT DF LIMIT | RIGHT DF LIMIT | PROPELLANT TEMPERATURE | |
| | 1268 | 3610 | 2810 | +37 | |
| SENSITIVE ITEMS | | | | | |
| YES or <input checked="" type="radio"/> NO M2 COMPASS SERIAL #1486 LOST LAST POSITION | | | | | |

Figure 2-8. Sample section chief's report (front)

| PART II. AMMUNITION STATUS FOR 155-MM HOWITZERS | | | | | | |
|---|-------------------------------|------------|-----------------------|-----|---------|------|
| PROJECTILES | | | PROPELLANTS | | FUZES | |
| HE | 4 <input type="checkbox"/> 68 | LOT MH43C | M3A1 GREEN BAG | | M577 | M565 |
| | 5 <input type="checkbox"/> 24 | LOT MHN88 | 30 LOT RAD81C | LOT | 5 | 6 |
| WP [M110] | 8 <input type="checkbox"/> 6 | LOT BC 43H | M482 WHITE BAG | | M564 | M739 |
| | <input type="checkbox"/> | LOT | 79 LOT IND87K | LOT | 68 | 56 |
| HC | <input type="checkbox"/> | LOT | M119A1 CHG 8 WB | | M582 | M732 |
| | <input type="checkbox"/> | LOT | LOT | LOT | 18 | 24 |
| RAP | <input type="checkbox"/> | LOT | M119A2 CHG 7 RED BAG | | M728 | M577 |
| | <input type="checkbox"/> | LOT | LOT | LOT | | |
| ICM | <input type="checkbox"/> | LOT | M203 CHG 8S RED BAG | | | |
| | <input type="checkbox"/> | LOT | LOT | LOT | | |
| DPICM | <input type="checkbox"/> | LOT | M203A1 CHG 8S RED BAG | | PRIMERS | |
| | <input type="checkbox"/> | LOT | LOT | LOT | M82 109 | |
| ADAM | <input type="checkbox"/> | LOT | ILLUM | | | |
| | <input type="checkbox"/> | LOT | 6 LOT 519M | LOT | | |
| RAAMS | <input type="checkbox"/> | LOT | REMARKS | | | |
| | <input type="checkbox"/> | LOT | | | | |
| SMK WP [M825] | 6 <input type="checkbox"/> 5 | LOT MC83J | | | | |
| | <input type="checkbox"/> | LOT | | | | |

| PART III. AMMUNITION STATUS FOR 203-MM HOWITZERS | | | | | | |
|--|--------------------------|-----|------------------------------|-----|-------|------|
| PROJECTILES | | | PROPELLANTS | | FUZES | |
| | <input type="checkbox"/> | LOT | M1 GREEN BAG | | M557 | M739 |
| | <input type="checkbox"/> | LOT | LOT | LOT | | |
| | <input type="checkbox"/> | LOT | M2 WHITE BAG | | M564 | M565 |
| | <input type="checkbox"/> | LOT | LOT | LOT | | |
| | <input type="checkbox"/> | LOT | M188 CHG 8 WHITE BAG | | M577 | M582 |
| | <input type="checkbox"/> | LOT | LOT | LOT | | |
| | <input type="checkbox"/> | LOT | M188A1 CHG 8 AND 9 WHITE BAG | | M728 | M732 |

Figure 2-9. Sample section chief's report (reverse)

Section V
TACTICAL MARCHES

2-21. METHODS OF MOVEMENT

A tactical march is the movement of a unit or elements of a unit under actual or simulated combat conditions. There are several methods of moving the platoon in a tactical configuration. Each method has its specific advantages and disadvantages. The BC or platoon leader decides which method or combination of methods is best. The methods discussed in this section are open column, close column, infiltration, and terrain march.

2-22. OPEN COLUMN

The open column road movement is used for daylight movements when there is an adequate road network that is not overcrowded, when enemy detection is not likely, when time is an important factor, and when there is considerable travel distance involved. Vehicle interval in an open column is generally 100 meters.

a. Advantages of this method are as follows:

- Speed (the fastest method of march).
- Reduced driver fatigue.
- Improved vision on dusty roads.
- Ease in passing individual vehicles.
- Ease in dispersing vehicles as a passive defense measure against an air attack.
- Less chance of the entire unit being ambushed.

b. Disadvantages of this method are as follows:

- Greater column length requires more road space.
- Other traffic often becomes interspersed in the column.
- Communication within the column is complicated.

2-23. CLOSE COLUMN

For close column movement, the vehicle interval is less than 100 meters. At night each driver can observe the "cat-eyes" of the blackout markers on the vehicle in front of him and maintain an interval of 20 to 50 meters (Figure 2-10). If the driver sees two marker lights, the interval is too great. If the driver sees eight marker lights, he is too close. If the driver sees four marker lights, he is maintaining the proper interval. During daylight, close column is used when there is a need for maximum command and control; for

example, during periods of limited visibility or when moving through built-up or congested areas.

a. Advantages of this method are as follows:

- Simplicity of command and control.
- Reduced column length.
- Concentration of defensive firepower.

b. Disadvantages of this method are as follows:

- Column is vulnerable to enemy observation and attack.
- Strength and nature of the column are quickly apparent to enemy observers.
- Convoy speed is reduced.
- Driver fatigue increases.

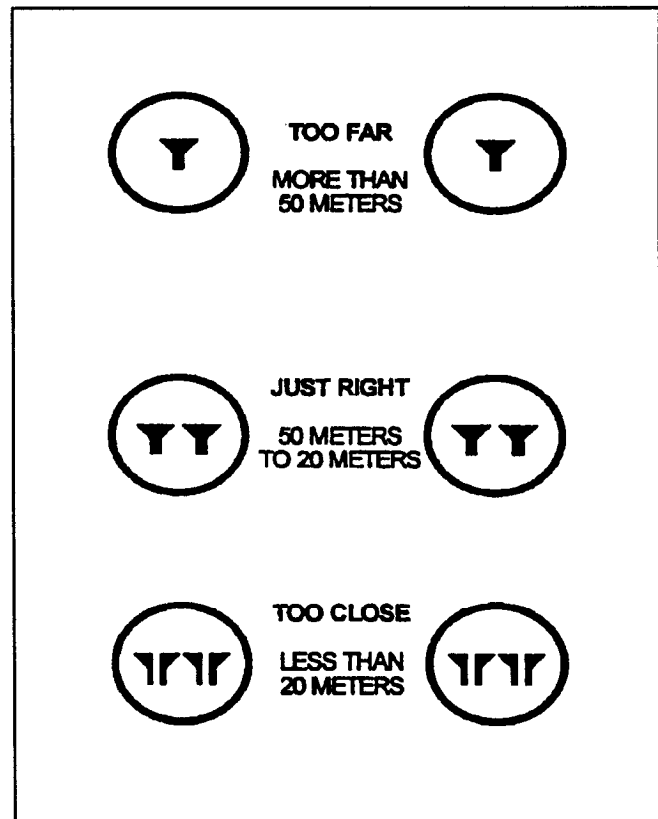

Figure 2-10. Blackout markers (cat's-eyes)

2-24. INFILTRATION

When the platoon moves by infiltration, vehicles are dispatched individually or in small groups without reference to a march table. This technique is time-consuming and the vehicles are difficult to control. It is used when the enemy has good target acquisition means and quick reaction capabilities.

a. Advantages of this method are as follows:

- Least vulnerable to hostile observation.
- Ideal for covert operations.
- Provides passive defense against air and artillery attack.
- Deceives the enemy as to the size of the unit.

b. Disadvantages of this method are as follows:

- Time-consuming.
- Most difficult to command and control.
- Small elements are more vulnerable to ground attack.
- Individual vehicles may get lost.

2-25. TERRAIN MARCH

The terrain march is an off-road movement. A unit using this type of movement should travel close to tree lines, along gullies, and close to hill masses (see Figure 2-11). A terrain march should be conducted when enemy observation or interdiction by artillery fire or air attack is likely. A platoon may move safely on a road for some distance and change to a terrain march at a point where enemy observation becomes likely or vehicle congestion provides the enemy an inviting target.

a. Advantages of this method are as follows:

- Strength and nature of a column are difficult to determine.
- Avoids traffic.
- Provides passive defense against air and artillery attack.

b. Disadvantages of this method are as follows:

- Displacement time may be increased.
- Ground reconnaissance is required.
- Soil conditions may complicate this type of movement.
- Improper movement leaves wheel or track marks to the new position.
- Extensive coordination is required to avoid traveling through other unit areas.

c. The battery using the terrain march may move in open or close column or by infiltration. The battery can displace either as a unit or by echelon. Continuous fire support is essential.

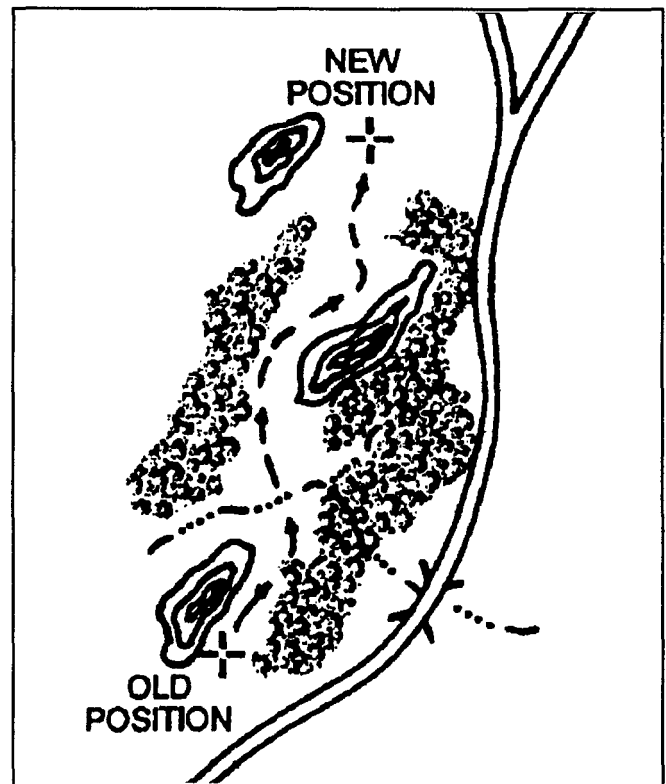

Figure 2-11. Terrain march

Section VI

PREPARING FOR MOVEMENT

2-26. ORDERS

The details given in a march order depend on the time available, the tactical situation, and traffic conditions. The order may be supplemented by strip maps, sketches, and march tables. The main items in a march order are based on the battery commander's reconnaissance order. They are as follows:

- Situation.
- Mission.
- Destination.
- Organization, to include order of march and composition of the column.
- Instructions from the XO or platoon leader to the main body. These should include start point, checkpoints, designated rally points, release point, times for arrival at and clearance of these points, rate of march, vehicle interval, route of march, order of march, and review of immediate actions to take in case of trouble.
- General instructions regarding restrictions on use of roads, maximum speed of march units, catch-up speeds, alternate routes, detours, use of lights and any special instructions regarding march discipline or defense against air or ground attack.
- Communication instructions regarding the use of radio, messengers, flags, whistle or horn signals, pyrotechnic signals, and hand and arm signals.

2-27. LOAD PLANS

A load plan prescribes efficient loading of personnel and equipment for movement. Each vehicle should have one. A good load plan is insurance that a unit will move into the new position with all its equipment. The load plan for a vehicle must be such that the equipment most essential to the mission is loaded last. The load plan should be recorded and graphically portrayed. Load plans should be identical between like sections within the same battalion. The load plan should be combat configured (complete rounds), based on the "go to war" basic load. Steps in preparing the load plan include the following:

- Examining the battery TOE to determine the personnel, equipment, and vehicles authorized for each section.

- Carrying non-TOE property in the section responsible for using it.
- Listing the personnel and equipment to be carried in each vehicle. Equipment should be located to facilitate identification under blackout conditions.
- Practice loadings to test the validity of the load plan.
- Establishing a list of items that must be removed from the vehicle and carried forward if the vehicle becomes disabled.
- Using load plans. Operator manuals and Appendix E of this publication present examples.
- Indicating that howitzers and ammunition vehicles use separate camouflage nets.

2-28. MOVEMENT PREPARATIONS

When the command **PREPARE TO MARCH ORDER** is given, everything possible will be done to quickly displace the unit. However, these actions must not hamper the ability to continue to deliver fire. Actions may include, but are not limited to, the following:

a. Stow section equipment.

Note: The collimator and any equipment or item forward of the howitzers remains in place until receipt of the final command MARCH-ORDER.

b. Upload all ammunition. Transload ammunition from the ammunition vehicle to the howitzer to allow maximum ammunition availability at the next position.

c. Stow camouflage nets.

d. Load all service elements (mess, maintenance, and so forth).

e. Ensure that security is continuous.

2-29. ORGANIZATION OF THE COLUMN

The organization of the battery or platoon column varies according to the tactical situation, the threat, and the position area to be occupied. The following points should be considered:

- a. In areas where enemy attack is probable, the cannons should be dispersed throughout the entire column.**

b. If feasible, there should be two air guards per vehicle. One scans the sky forward of the vehicle while the other scans the sky rearward.

c. Machine guns should be distributed evenly throughout the column and should be aimed alternately to the left and right sides of the route of march.

d. Unit instructions should specify that some personnel fire 3-5 round bursts and some personnel fire on semiautomatic to maintain continuous fire.

e. The NBC detecting and monitoring equipment should be located with the lead vehicle of the convoy. The unit could upgrade its MOPP level during movement.

Section VII

CONDUCTING THE MARCH

2-30. MARCH DISCIPLINE

a. Officers and NCOs ride where they can best control the march. The senior person in each vehicle is responsible for ensuring that all orders concerning the march are carried out.

b. Key personnel should disperse throughout the column. This should preclude losing a disproportionate number of these persons as a result of enemy action.

c. The column must keep moving. Procedures for the pick up of mission-essential personnel and equipment if a vehicle breaks down should be indicated in the unit SOP. For example, the driver stays with the vehicle and the maintenance representative stops to help. If the disabled vehicle cannot be repaired in a reasonable time or recovered by the platoon, the position and condition of the vehicle are reported to the BC for recovery. The maintenance representative must proceed along the route of march as soon as possible to be available to the rest of the platoon.

d. Each vehicle commander is responsible to watch for signs, markers, signals, and other traffic.

e. The specific objective of march discipline is to ensure intelligent cooperation and effective teamwork by march personnel. Teamwork includes the following:

- Immediate and effective response to all signals.
- Prompt relaying of all signals.
- Obedience to traffic regulations and control personnel.
- Use of cover, concealment, camouflage, dispersion, blackout precautions, smoke, and other protective measures against air, ground, armor, and NBC attack.
- Maintaining correct speeds, positioning, and intervals between vehicles within the column.
- Ability to recognize route marking signals and signs.

2-31. CONVOY CONTROL MEASURES

The control measures discussed below help in convoy movement:

a. The **start point** is normally a geographical feature identifiable on the ground and on a map. The first vehicle of the convoy must cross the start point at the specified start time. The BC is responsible for determining the route to the start point and the time it will take to get there. If the unit is displacing as part of a battalion move, the start point is also the point at which control of the marching element is normally assumed by battalion.

b. Normally, a **checkpoint** is a geographical feature identifiable on the ground and on a map. It is used in reporting progress along the route of march. It may be used as a target when planning fires in defense of the convoy.

c. Normally, the **release point** is normally a geographical feature identifiable on the ground and on a map. The last vehicle of a convoy must cross the RP at the specified time. The BC is responsible for determining the route from the RP to the new position area. If the unit is displacing as part of a battalion move, the RP is also the point at which control of the marching element is regained by the platoon. The BC or GSG may send a vehicle from the advance party to the release point to lead the unit into the new position area.

d. A **pickup point** is a location, normally within the position, where the gun guide meets the howitzer and guides it into position.

e. Normally, a **rally point** is a geographical feature identifiable on the ground and on a map. It is used as a point of assembly and recovery from dispersion due to enemy attack. The designated rally point(s) should be located near or on the alternate route to the new position.

f. **Route marking** aids in the move. The route-marking detail marks the route by posting signs and/or personnel at those critical locations where elements of the march might

make a wrong turn. Details concerning traffic control and route marking are presented in FM 55-30 and FM 19-25.

g. Predetermined signals should be established to aid in convoy control. Colored flags in daylight and flashlights at night can aid in simple but important communications within the column. (See FM 21-60.)

2-32. HALTS

a. During administrative marches, halts are made at regular intervals or at selected sites. They allow personnel to rest, to service the vehicles, and to check the loads. Normally, halts are not scheduled for tactical marches.

b. During extended vehicle marches, wooded areas, built-up areas, and appropriate terrain should be selected as halting places. They provide concealment and do not present a straight line of vehicles for attack by enemy aircraft. Avoid stopping near crossroads, railroads, and other easily identifiable reference points.

2-33. MARCH COLUMN CONTINGENCIES

a. Immediate Action Procedures. A unit must always assume that it is a high-priority target and vulnerable to all kinds of attack while moving. Preplanned immediate actions can decrease vulnerability. In establishing immediate action procedures, the BC or platoon leader should consider the following:

- The enemy situation-with what he expects to be attacked.
- The organic resources for countering the different types of attack.
- The nonorganic support available for countering attacks.
- The amount of time available for training the platoon in the particular immediate actions (for example, infantry squad tactics in response to a blocked ambush).
- The type of communications to be employed with the immediate actions-flags, radio, arm and hand signals, and so forth.
- How best to neutralize the attack.
- Planned tires along the route of march.

In all cases of enemy attack, conduct immediate action procedures and then report the situation to higher headquarters.

b. March Column Under Artillery Attack. The immediate actions in defense against hostile artillery fire are to move out of the danger zone, report the situation to

higher headquarters, and request immediate counterfire. If a platoon expects hostile artillery fire during the march, it can reduce its vulnerability by moving-

- By open column or infiltration.
- Under the cover of darkness or during other periods of reduced visibility.
- By terrain march.

c. March Column Under Air Attack. In the event of an air attack, all available personnel should engage the aircraft immediately. On order of the convoy commander, the column either disperses or halts. If ordered to halt, vehicles should disperse alternately off both sides of the road. A high-performance aircraft cannot be engaged effectively by leading it with low-volume, independent small arms fire. As the aircraft approach, all personnel fire their weapons in the air to form a wall of bullets through which the aircraft must fly.

d. Roadblocks. An element may be halted by a roadblock. The maximum amount of firepower available, including howitzer direct fire, should be placed immediately on the roadblock and on both sides of the roadblock. If nonorganic support, such as close air support, covering artillery, or armor is available, it should be called on immediately to help. If the roadblock cannot be neutralized, the unit must try to disengage under cover of supporting fires. Upon disengaging, the element should meet at a designated rally point and resume its march by an alternate route. An attempt to crash vehicles through a roadblock before it is checked for mines may result in unnecessary losses and a complete blocking off of the road by disabled vehicles.

e. Ambush.

(1) There are two types of ambushes-blocked and unblocked. Both must be countered in the same manner-get out of the kill zone, neutralize the ambushing force with firepower, and report.

(a) *Blocked ambush.* If the route is blocked, maximum available fire should be placed immediately on the attacking forces. Personnel in the kill zone should immediately dismount, attack as infantry and report. Staying in the kill zone is the worst course of action. The portion of the element that is not in the kill zone must also react immediately. There are few ambushing forces that can equal the organic firepower of an artillery unit. Use the howitzers to place fire on the ambushing force; then roll up the flanks of the enemy.

(b) *Unblocked ambush.* In an unblocked ambush, the element should increase speed and move through the ambush area while placing the maximum amount of small arms and automatic weapons fire on the attackers and report.

(2) A consideration in employment of the main armament of the howitzer from the kill zone is that the targets may be too close for proper fuze action. Only the 105-mm antipersonnel round (M546) can be set for muzzle action to engage targets close to the weapon.

(3) If the area was identified during the map inspection as a likely ambush site, on-call fires are executed. Otherwise, a fire request is sent immediately to the battalion FDC.

(4) If the ambush or any other enemy action is of such magnitude as to cause the column to break up, individual elements should proceed to the new position or designated rally point on their own.

2-34. OTHER MOVEMENTS

a. Detailed descriptions of the various types of movements and marches are in the following manuals:

- FM 55-30, which includes information on the organization of motor movements, the movement of personnel, and the planning of motor movements.
- FM 100-50.
- FM 101-10-1, which includes planning guidance for movements.

b. When the unit moves by rail, air, or water, it normally moves as an element of the FA battalion or with a supported unit. In any case, the battery receives detailed instructions in the form of a movement order or pertinent extracts from

the movement order. A warning order alerts the battery and gives enough information of the impending movement for the battery to make plans and to take the necessary preliminary action. The references listed below provide adequate information for the following types of movement:

- Movement by rail—FM 55-15, TM 55-601.
- Movement by air—FM 55-9, FM 55-12, FM 90-4, and FM 101-10-1.
- Movement by water—FM 55-15 and FM 101-10-1.

2-35. MOVEMENT PROCEDURES

The BC ensures that movement procedures are included in the unit SOPs. He should consider the following items before establishing a movement SOP:

- Tips on establishing a realistic movement SOP (paragraph 2-41).
- References identified in this chapter.
- STANAG 2041 and QSTAG 520, *Operation Orders, Tables and Graphs for Road Movement* (see FM 55-30 for applicable details).

STANAG 2154 and QSTAG 539, *Regulations for Military Motor Vehicle Movement by Road* The applicable details of this agreement to be included in unit SOPs are extracted from STANAG 2154 and are shown below.

* * * * *

EXTRACT STANAG 2154 (Edition 6) REGULATIONS FOR MILITARY MOTOR VEHICLE MOVEMENT BY ROAD

* * * * *

5. Composition of Columns.

- a. A column may be composed of a number of organized elements.
- b. Each organized element includes:
 - (1) A commander whose location may vary.
 - (2) In the first vehicle: a subordinate commander known as the pace setter.
 - (3) At the end a subordinate commander known as the trail officer.
- c. A reporting officer* is to precede each column. His function is to report the details of the column to each traffic control post or border crossing point as applicable.
- d. A reporting officer* (who may be the trail officer) is to be appointed to report to each traffic control post once the column has passed, giving details of any occurrences including vehicle casualties.
- e. Each vehicle must have a vehicle commander, who may be the driver. He is responsible for both crew discipline and the execution of the mission.

* May be of any rank as considered appropriate by the column commander.

6. Identification of Columns.

a. Movement Number (Example at Annex A).

- (1) Each column which has been allocated a movement credit must be identified by a number known as the "movement number." This number identifies the column during the whole of the movement, including the crossing of national boundaries.
- (2) The movement number is to be placed on both sides of each vehicle. It must be permanently legible, from ground level, at a minimum distance of 6 meters in normal daylight.
- (3) The movement number must be white or yellow and remain legible in all weather during the whole movement. It must be removed as soon as the movement is completed.

b. Minimum Lighting and Flagging.

- (1) In peacetime, headlights of all vehicles moving in the column must be on at all times (low beam).
- (2) The first vehicle of each element must display a blue flag mounted on the front left-hand side of the vehicle.
- (3) The last vehicle of each element must display a green flag mounted on the front left-hand side of the vehicle.
- (4) The column commander should display a white and black flag at the front left-hand side as indicated below:



- (5) The driver of a broken down vehicle must remove the flag(s) and filter (light) and if technical assistance is required, a yellow flag is to be attached to the vehicle so that it is visible to approaching traffic.
- (6) Flags must be approximately 30 cm (12 in) x 45 cm (18 in) in size.
- (7) To obtain legal rights for column movements for different countries, see Annex D.

7. Movement Credit. A movement credit is issued by the National Movement Staff or the appropriate authority, on whose territory the movement starts. The credit is coordinated by that staff or authority with the movement staff or authority of another nation where the crossing of international boundaries is concerned. It is required for:

- a. Columns of vehicles in accordance with national regulations (see Annex C).
- b. Outsize or heavy vehicles in accordance with national regulations (see Annex B).
- c. In the case of border crossing movement, see STANAG 2176.
- d. Hazardous cargo (in accordance with national/military regulations).

8. Special Regulations for the Execution of Movement.

a. Halts.

- (1) Short halts made by columns normally are to last 10 minutes and should be taken where possible after every 2 hours of operation.
- (2) Long halts made by columns for at least 30 minutes must always be specifically plotted on road movement graphs.
- (3) The movement control staff can give additional instructions concerning time, duration and/or place of halts.
- (4) Particular attention is to be paid to the following aspects of traffic discipline during halts:
 - (a) When making a halt, single vehicles, or vehicles forming part of a column, should move off the roads as much as possible.
 - (b) If this practice cannot be observed, the commander of a column which is halted must take all necessary measures to facilitate movement of other road users and to avoid accidents or traffic jams. The measures to be taken will vary according to conditions and the width of the road and should include:

i. Warning at sufficient distance from the front and rear of the column (guards, warning flags, lights or flares).

ii. Organizing and directing a system of one-way traffic along the column.

b. Overtaking of Columns.

(1) Single vehicles are authorized to overtake columns during their halts or if there is a large speed differential. Vehicles may only overtake if it is safe to do so.

(2) Columns may only be authorized to overtake other columns by the movements control authorities and, if so, the overtaking maneuver has to be supported by traffic regulation personnel.

(3) A column without movement credit may overtake another column in the following circumstances:

(a) When the other column is halted and it is safe to do so.

(b) When the column commander of the leading column gives clear intention that the following column may overtake and it is safe to do so.

c. Road Movement of Outsized or Heavy Vehicles/Equipment (Special Movement). Special application for the movement of outsize or heavy vehicles must be made before movement credits are granted. National restrictions, above which special application to move must be made, are contained in Annex B.

d. Tactical Situation.

(1) On principle, the directions from the local police and from the military police must be obeyed. In times of crisis or in wartime the tactical situation may require a deviation from one or more regulations laid down in this agreement. Such situations may occur for the units in case of immediate danger of enemy threat.

(2) In times of crisis or in wartime, night movements will also have to be accomplished without or with restricted lighting (black out lighting) depending on the situation, with due regard to regulations in force to the host nation. It is desirable that a device be incorporated in the vehicle lighting switch, in order to prevent the driver inadvertently switching on driving lights, passing lights or direction indicators while the vehicle is operating under black out conditions.

* * * * *

ANNEX A TO STANAG 2154 (Edition No. 6)

REGULATIONS FOR MILITARY MOTOR VEHICLE MOVEMENT

BY ROAD

TERMS AND DEFINITIONS

* * * * *

2. Terms and Definitions used for the purpose of this Agreement.

a. Column. A group of vehicles moving under a single commander, over the same route, at the same time in the same direction.

b. Organized Element. Marching groups, convoys, packets (STANAG 2155 refers).

c. Movement Number. Number, allocated to a movement by the movement control staff responsible for the issue of a movement credit. The movement number should comprise:

(1) Two figures indicating the day of the month on which the movement is due to commence.

(2) Three or more letters indicating the movement agency issuing the movement credit, the first two letters being the national symbols of the movement agency (see STANAG 1059).

(3) Two or three figures indicating the serial number of the movement.

(4) One letter to identify the element of the column (this is optional).

Example below:

15 NLA 41D

d. Special Movement. Road movement of vehicles/equipment with or without load which requires movement credit because of class, dimension or movement restriction based on national requirements.

e. Trail Officer. A subordinate commander in each column who travels at the rear of the column. His duties are to be determined by the column commander. His duties may include:

- (1) Reporting type and location of dropped-out vehicles.
- (2) Organizing the safety measures at the rear of the column required at halts.
- (3) Observing and reporting column discipline.

* * * * *

ANNEX B TO STANAG 2154 (Edition No. 6) REGULATIONS FOR MILITARY MOTOR VEHICLE MOVEMENT BY ROAD SPECIAL MOVEMENT

All vehicles/equipment exceeding dimensions or qualifications listed below must be considered as special movement and need road movement credit (see Annex C).

* * * * *

| Country | all measures in meters | | | | | | | class MLC |
|---------|-----------------------------------|------------------|---|---|--------------------|-------------|-------------------------------|------------------|
| | width (including all projections) | length in meters | | | | motor coach | total height (including load) | |
| | | single vehicles | combined vehicles (prime and semi vehicles) | articulated vehicles (tractor and trailers) | | | | |
| | | | | total length of train | length of one unit | | | |
| BE | 2.5 | 12 | 15.50 | 18 | 11 | 12 | 4 | <50 |
| CA(2) | 2.6 | 12.2 | 20.0 | 23.0 | — | 12.2 | 4.5 | ? |
| DA | 2.5 | 12 | 15.50 | 18 | 12 | 12 | 3.60 | <35 |
| FR | 2.5 | 11 | 15 | 18 | 11 | 12 | — | <50 |
| GE | 2.5 | 12 | 15.50 | 18 | 12 | 12 | 4 | — |
| GR | 2.5 | — ⁽⁴⁾ | 14 | 18 | — | 12 | 3.8 | ? |
| IT | 2.5 | — ⁽⁴⁾ | 15.50 | — ⁽⁵⁾ | 12 | 12 | 4 | (3);(6) |
| LU | 2.5 | — ⁽⁷⁾ | 15 | 20 | — ⁽⁴⁾ | 12 | 4 | <40 |
| NL | 2.6 | 12 | 15.50 | 18 | — | 12 | 4 | — ⁽⁸⁾ |
| NO | 2.5 | 12.4 | 15 | 18 | — | 12.4 | 3 | <50 |
| PO | 2.5 | 12 | 18 | 12 | 12 | 12 | 4 | <50 |
| SP | 2.5 | 12 | 16.5 | 18 | — | 12 | 4 | ? |
| TU | 2.5 | 10 | 14 | 16 | — | 11 | 3.8 | ? |
| UK | 2.5 | 11 | — ⁽¹⁰⁾ | 18 | — ⁽¹¹⁾ | (12) | — ⁽¹³⁾ | <50 |
| US | 2.438 | 10.668 | 15.24 | 18.288 | 10.668 | 12.192 | 3.81 | <50 |

Explanatory notes

1. a. Generally in most provinces and designated highways, size limits exceed the limitations quoted;
 - b. In some provinces certain types of articulated trains are not permitted;
 - c. Weight limitations are based on axle loads, axle spacing and tire size. They vary by provinces and designated highways. Restrictions on weight may be imposed during spring thaws.
2. For vehicles and trailers with pneumatic tires the permissible axle load and the permissible total width must not exceed the following values:
 - a. Single axle load
 - (1) single axles: 10.0 t
 - (2) single axles (live), except for two-axle busses: 10.0 t
 - b. Double axle load, taking into consideration the regulations for the single axle load:
 - (1) axle distance less than 1.00 m: 11.0 t
 - (2) axle distance 1.00 m to less than 1.30 m: 11.0 t
 - (3) axle distance 1.30 m to less than 1.30 m: 16.0 t
 - (4) axle distance more than 1.90 m: 20.0 t
 - c. Triple axle load, taking into consideration the regulation for the single axle load and the double axle load:
 - (1) axle distance 1.30 m or less: 21.0 t
 - (2) axle distance more than 1.30 m to 1.40 m: 24.0 t
 - d. Total weight of individual vehicles, except for semi-trailers, taking into consideration the regulation for axle loads:
 - (1) vehicles with not more than 2 axles:
 - (a) vehicles: 16 t
 - (b) vehicles with live axle according to point a(2): 17.0 t
 - (c) trailers: 18.0 t
 - (2) vehicles with more than 2 axles:
 - (a) vehicles and trailers: 24.0 t
 - (b) busses which are constructed as articulated vehicles: 28.0 t
 - (c) vehicles with 2 double axles, the centers of which are at least 4.00 m apart: 32.0 t

e. Total weight of vehicle combinations (towing vehicles and semi-trailers) taking into consideration the regulations for axle loads and individual vehicles:

- (1) vehicle combinations with less than 4 axles: 27.0 t
 - (2) two-axle vehicle with two-axle trailer or semi-trailer: 35.0 t
 - (3) other vehicle combinations with more than 4 axles: 34.0 t
 - (4) vehicle combinations with more than 4 axles: 40.0 t
 - (5) three-axle vehicle with two- or three axle semi-trailer which transports a 40 foot ISO container in combined freight traffic within the meaning of Directive 73/130/EEC on the determination of common rules for specific transports in combined freight traffic between member nations in the version dated 28 July 1982 (Official EC Bulletin No. L247, page 6): 44.0 t
3. Motor vehicles with one rear-axle: 11 m (IT motor coaches excluded). Motor vehicles with two or more axles: 12 m.
 4. 18 m; less if turning radius (a) exceeds 12 m and/or circular crown of turning way (b) is more than 5.30 m.

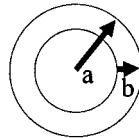

5. =<50; highways can be considered up to class 120; in peacetime forbidden for tracked vehicles.
6. Vehicles with:
 - a. 1 axle: 7 m;
 - b. 2 axles: 10 m;
 - c. 3 or more axles: 12 m.
7. Maximum:
 - total weight: 50,000 kg (50 tons);
 - single axle load: 10,000 kg (10 tons);
 - double axle load: 8,000 kg (18 tons);
 - : 20,000 kg (20 tons), axle distance>2.00 m;
 - triple axle load: 24,000 kg (24 tons).
8. 15 m; for container transporters a maximum length of 15.50 m is allowed.
9. Max. load per single axle: 13 t
Max. load per tandem axle: 21 t
(Two single axles separated 1.5 m or less are considered a tandem axle)
From a separation of 1.35 m down, the maximum limit of 21 t has to be reduced in 700 kg for each decrease of 0.05 m in the distance between the twin axles.
Vehicles with two axles, max weight: 20 t
Vehicles with three axles, max weight: 26 t
Vehicles with more than three axles, max weight: 38 t
Combined or articulated vehicles, max weight: 38 t
Max load density between farthest axles: 5 t per meter
Max pressure to the road: 9 Kg per square centimeter.

10. In UK there is no legal limit applied to the length of a semi-trailer, however, due to the constraints of the Construct and Use Regulations (UK) which limit the maximum tractor/semi-trailer combination length to 15 m, the semi-trailer-length cannot exceed 12.2 m; in practice this is reduced normally to 12 m.
11. 12 m; for trailers with 4 or more wheels and a distance between the heart of the two outmost rear axles of more than three/fifth of the trailers overall length and provided that own weight of the tractor is 2030 kg or more; otherwise the length of a trailer may not exceed 7 m.
12. 12 m for a motor coach fit up for more than 8 seated passengers which can turn within a circle of 24 m diameter.
13. 4.57 m; for a large motor coach as described at note (12). For motorlorries there is no limit, but certain vehicles over 3.658 m height must carry a notice stating height in feet and inches in the cab. Bridge heights on secondary roads allow vehicles up to 3.962 m height.

* * * * *

ANNEX C TO STANAG 2154 (Edition 6)
REGULATIONS FOR MILITARY MOTOR VEHICLE
MOVEMENT BY ROAD
TABLE LISTING THE MINIMUM NUMBER OF VEHICLES FOR WHICH
A MOVEMENT CREDIT IS REQUIRED

* * * * *

| NATION | | BE | CA | DA | FR | GE | GR | IT | LU | NL | NO | PO | TU | UK | US |
|--------------------|-----------|----|----|----|----|----|----|----|----|----|----|----|----|----|----|
| Number of vehicles | Peacetime | 20 | 31 | 20 | 20 | 31 | 1 | 10 | 20 | 10 | 4 | 10 | 1 | 5 | 6 |
| | Wartime | 20 | 31 | 20 | 20 | 31 | 1 | 10 | 20 | 10 | 4 | 10 | 1 | 5 | 6 |

* * * * *

| | |
|----------------|---------------------|
| LEGEND: | |
| BE = Belgium | LU = Luxembourg |
| CA = Canada | NL = Netherlands |
| DA = Denmark | NO = Norway |
| FR = France | PO = Portugal |
| GE = Germany | TU = Turkey |
| GR = Greece | UK = United Kingdom |
| IT = Italy | US = United States |

* * * * *
ANNEX D TO STANAG 2154 (Edition 6)
NATIONAL MARKING OF COLUMNS AND LEGAL RIGHTS
* * * * *

Country BE and DA

1. Flagging

See 6.b. "Minimum lighting and flagging".

2. Lighting

See 6.b. "Minimum lighting and flagging".

3. Legal rights

None.

Country GE

1. Flagging

- a. Columns consisting of three or more vehicles are to be marked by flags. All vehicles except for the last vehicle display a blue flag. The last vehicle displays a green flag.
- b. If a column is separated in several independent elements and if the distance between the last vehicle of the following element exceeds the distance ordered between the individual vehicles each element of the column is to be marked by flags according to the provisions for a column.

2. Lighting

Also during the day the headlights of all vehicles moving in column must be on.

3. Other provisions

In order to warn the following rapid traffic on highways and freeways the last vehicle may display an omnidirectional amber light, or if this light is not available the last vehicle may display operating hazard warning lights instead.

4. Legal rights

Closed formations moving in column must leave gaps for the remaining traffic at appropriate intervals. Such traffic must not interrupt the column at any other point. Hence follows that a closed formation or an element thereof is to be considered one road user. That also applies at crossings and junctions. If a part of the formation has already moved into a crossing, the next vehicle must not wait when a vehicle approaches on the road with right-of-way or from the right. It is, however, not justifiable that that right of way is called upon without warning the remaining road users.

The warning tasks (no traffic regulation) may be accomplished by military police forces or other military personnel unless police forces regulate the traffic. Military police forces or military personnel detailed for warning must be clearly recognizable as military traffic posts (warning posts), e.g. by brassards or respective clothing.

When accomplishing their tasks, military traffic posts are to use the same signals as prescribed for traffic regulation by police forces (STANAG 2025). Other signals to warn road users-where necessary and appropriate-must, however, not be excluded. Warning of the other road users must not be accomplished as a traffic regulation function. Only the German Police has traffic regulation authority over civilian road users.

The priority rights of closed formations must not be called upon if:

- the traffic is regulated in another way by police forces;
- other road users call upon priority by displaying a blue flashing light together with a signal horn. Such vehicles must always be given free way;
- a threat to other road users cannot effectively be prevented by traffic regulation by police forces, warning by military police forces or other military personnel detailed for that tasks. That applies especially if the traffic is regulated by alternating lights, permanent lights (traffic signals) or by the traffic signs "Stop! Give way" or "Give way!".

Country GR

1. Flagging

- a. See 6.b. "Minimum lighting and flagging";
- b. The driver of a broken down vehicle must remove the flag and filter (light) and, if technical assistance is required, a yellow flag is to be attached to the vehicle so that it is visible to approaching traffic.

2. Lighting

- a. The first vehicle of each element must display a blue filter on the front left-hand side headlight or a blue light;
- b. The last vehicle of each element must display a green filter on the front left-hand side headlight or a green light.

3. Legal rights

If part of the column/element, complying to the above stated national requirements, has already moved into a crossing, the next vehicles have right of way. This right should be exercised with necessary caution. Civilian drivers are not to disturb or obstruct a column.

Country: NL

NL requirements for marking of columns in peacetime only:

1. Flagging

- a. Two blue flags displayed on the first vehicle of an element mounted on the left- and right-hand front side of the vehicle;
- b. One blue flag displayed on each following vehicle of an element, except for the last vehicle, mounted on the right-hand front side of the vehicles.

2. Lighting

- a. Headlights (low beam) of all vehicles moving in column must be switched on at all times;
- b. Each vehicle except the last of each element must display a blue filter in the front right-hand side headlight;
- c. The last vehicle of each element must display a green filter on the front right-hand side headlight.

3. Legal rights

If a part of the column/element, complying to the above stated national requirements, has already moved into a crossing, the next vehicles have right of way. This right should be exercised with necessary caution. Civilian drivers are not to disturb or disrupt a column.

Country: NO

1. Flagging
 - a. See 6.b. "Minimum lighting and flagging";
 - b. One sign displayed on the front-side of the first vehicle and one sign displayed on the rear-side of the last vehicle of an element stating "MILITAER KOLDNNE" (black capital characters on a white board).
2. Lighting

See 6.b. "Minimum lighting and flagging".
3. Legal rights

Columns complying to the above stated national requirements have right of way. Civilian drivers are not to disturb or obstruct a column.

Country: SP

1. Flagging

See 6.b. "Minimum lighting and flagging".
A red flag must be displayed on vehicles carrying explosives or ammunition, dimensions are not required.
2. Lighting

See 6.b. "Minimum lighting and flagging". In order to warn the following rapid traffic on highways and freeways the last vehicle may display an omnidirectional amber light.
3. Other provisions

A hazard triangle must be displayed at the front of the first vehicle and at the rear of the last vehicle:

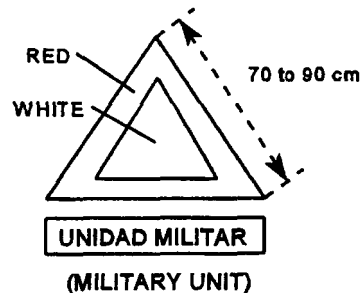

4. Legal rights

None.

Country: UK

1. Flagging

In the UK the national regulations do not recognize column flagging of any sort.
2. Lighting

See 6.b. "Minimum lighting and flagging".
3. Legal rights

None.

* * * * *

Section VIII

OCCUPYING THE POSITION

2-36. TYPES OF OCCUPATION

This section describes three types of occupation—deliberate, hasty, and emergency. Also, the key functions performed in laying and readying the battery or platoon for firing and for sustaining operations are addressed. Regardless of the type of occupation, local security must be established and maintained.

a. A deliberate occupation is one that has been planned. The advance party precedes the unit and prepares the position. The occupation may be during daylight hours following a daylight preparation, at night after a daylight preparation, or at night following a nighttime preparation. A common error in a deliberate occupation is allowing too much activity during preparation, thereby risking compromise. Only the minimum number of vehicles and personnel should go forward. When the tactical situation allows, a very good method of occupying a new position is to do the advance preparation prior to darkness and move by night. Nighttime movement following a nighttime reconnaissance is often necessary, but it can be more time-consuming.

b. The hasty occupation differs from the deliberate occupation mainly in the amount of time available for reconnaissance preparation. Generally, it results from unforeseen circumstances. The hasty occupation begins as a deliberate occupation, but due to limited time for advance party preparation of the next position, it becomes a hasty occupation. It reinforces the importance of the battery commander's planning ahead and establishing priority tasks.

c. An emergency occupation results when a call for fire is received while the battery or platoon is conducting a tactical movement.

2-37. DELIBERATE OCCUPATION

a. A guide meets the battery or platoon at the pickup point and leads the vehicles to the entrance of the position area. There the vehicle guides are waiting to lead the vehicles to their selected locations.

b. Each gun guide aligns his weapon on the azimuth of fire and gives the initial deflection to the gunner.

c. Intrabattery communications are used for laying.

d. The GSG implements the security and defense plan as personnel become available.

e. Other considerations for night occupations areas follow:

(1) Light discipline must be practiced. Proper preparation for a night occupation will minimize the need for lights. Vehicle blackout drive and blackout marker lights should be turned off as soon as the ground guide has begun to lead the vehicle into position. During the laying process, only the aiming circle (AC) and the weapon being laid should have any night lights on.

(2) Noise discipline is most important, since noise can be heard at much greater distances at night.

(3) The time for occupation is increased.

(4) Each vehicle guide should know where his vehicle is in the order of march so the platoon can move smoothly into position without halting the column.

(5) Filtered flashlights are used to lead the vehicles.

CAUTION

Each driver must stop his vehicle whenever he cannot see the light from the guide's flashlight.

(6) Vehicles will not move within the position without a guide.

2-38. HASTY OCCUPATION

In a hasty occupation, day or night, the platoon requires more time to occupy. This is because some preparatory tasks were not accomplished due to the limited time available. This may result in the following:

- Delay in getting the vehicles off the route of march.
- Laying by voice.
- Increased laying time, since gun guides might not have aligned the stakes on the azimuth of fire or obtained initial deflections.
- Increased FDC preparation time because not all initial updated location data will be available.

2-39. EMERGENCY OCCUPATION**a. General.**

(1) The nature of the emergency occupation requires a modification of the normal procedures used to occupy and lay. The procedures apply to all artillery units, towed and self-propelled.

(2) The key to success for the mission is a well-rehearsed SOP.

(3) The XO or platoon leader must know exactly where he is at all times during a road march. He must constantly be selecting possible emergency mission firing positions by map and visual reference. If possible, the BC or gunnery sergeant should identify suitable position areas for emergency missions along the route while performing his reconnaissance and pass this information to the platoon leader or XO.

b. Actions Upon Receipt of the Mission.

(1) The XO, platoon leader or FDO receives the call for fire and does the following:

- Authenticates the mission.
- Ensures FDC personnel monitored the call.
- Notifies the driver.
- Signals the convoy.
- Selects a firing position and passes the proposed coordinates to the FDC personnel.
- Determines the best method to lay the unit. In order of preference, the methods areas follows:
 - Grid azimuth method.
 - Howitzer backlay method.
 - Aiming point-deflection method.

(2) The FDC does the following:

- Determines the azimuth of fire.
- Starts computing initial data. See Appendix F for BCS emergency occupation procedures.

c. Communications. Data **must** be passed quickly and efficiently. The small unit transceiver (if available) is an effective tool. Wire can be used if the battery internal wire system is designed for very rapid emplacement. In the absence of these systems or if some elements are not operational, all key personnel must have relays and/or runners in position to get data as they become available. For example, as each nonadjusting howitzer is emplaced, a relay should move immediately to the aiming circle to get his deflection. Another runner should get firing data from the FDC.

d. Aiming Points. Aiming points will be established in the following priorities:

- Distant aiming point (DAP).
- Collimator.

- Aiming posts.

e. Security. In M109A3-5 units, for security, the M992 should automatically disperse in a semicircle from the right front around the rear of the position to the left front. They should be well outside the gun line and not be a factor in line of sight between the aiming circle and the howitzer. In towed weapon units where ammunition is carried separately, the prime mover should move to the rear as soon as possible to reduce line-of-sight problems and congestion. Administrative vehicles and their occupants should move into security positions.

f. Position Improvement. Upon completion of the mission, the tactical situation dictates whether the unit moves on or continues position improvement. The unit should make the five requirements for accurate predicted fire a priority. (A more detailed discussion of the five requirements is in FM 6-40.)

g. Teamwork. There are few tactical activities which require more teamwork than an emergency occupation. Everyone (drivers, gunners, relays, chiefs) must know his job and do it automatically. Remember, engines will be running, and if success depends on a leader shouting commands and directives to untrained personnel, the mission will surely fail.

2-40. SUSTAINING ACTIONS

a. Once the occupation is completed and the unit is ready to answer calls for fire, sustaining actions begin. They are continuous and done in the priority determined by the BC or platoon leader. These actions may include the following:

- Improve position defense plans.
- Improve camouflage.
- Bury and overhead wire lines.
- Harden critical elements.
- Perform maintenance.
- Rehearse reaction forces.
- Conduct training.
- Resupply all classes of supply.
- Complete position area survey.
- Be prepared to march-order.
- Improve the technical solution to meet the five requirements for accurate predicted fire.

b. Care must be taken in the way ammunition is resupplied and vehicles are refueled, particularly in SP units. These

activities can reveal the location of the battery. If possible, these tasks should be done at night.

c. The advance party should always be prepared to leave at a moment's notice.

2-41. TRAINING TIPS

a. During combat, a unit keeps proficient in those skills that are used day-to-day. If not used or practiced, skills that may be required later can be lost. Consideration should be given to conducting training during combat lulls. Such training will ensure that a platoon stays able to perform all skills required.

b. Training in convoy operations and immediate action procedures should conform to the unit SOP. This will ensure that personnel are adequately trained to cope with situations that may confront them. Some considerations for establishing a training program are discussed below:

(1) Establish a realistic movement SOP. It should conform to battalion SOPs and should cover, as a minimum, the following:

- Approval authority for displacing the battery or platoon.
- Duties of convoy commanders.
- Convoy organization.
- Weapons and ammunition to be carried.
- Hardening of vehicles.
- Protective equipment to be worn by personnel.
- Preparation of vehicles (detailed instructions regarding tarpaulins, windshields, and tailgates).
- Counterambush action.
- Drills in reaction to air or artillery attack.
- Security measures.

- Maintenance and recovery of disabled vehicles.
- Any scheduled refueling and/or rest halts.
- Establishment of rally points.

(2) Stress estimating and maintaining the specified interval between vehicles, especially if the column halts. Put interval-marking signs on your motor pool exit to help train drivers.

c. Teach the drivers to habitually evaluate the terrain in light of the cross-country mobility of their vehicles. Even in a well-developed area with a good road net, a driver may be required to make an off-road detour to bypass a roadblock or a section of damaged highway. The habit of constant terrain evaluation enables him to make a quick decision and select the most practical route promptly.

d. Practice terrain movement in small elements.

e. Practice immediate action. Include vehicle breakdowns, equipment transfer, and vehicle repair or recovery. Many such items can be in the SOPs.

f. Practice blackout movements to accustom the drivers to using the blackout lights. As they become proficient, restrict them to "cat's eyes" only.

g. Consider the following tips for increasing the units capability for rapid and secure tactical vehicle marches.

(1) Do not limit training to those times when the entire unit is available. Whenever two or more vehicles are going to the same place, conduct the movement as a tactical march.

(2) Find out how fast the unit can travel, both on and off the road, without losing the slowest vehicles. (Putting the slowest vehicles up front will automatically pace the column.)

(3) As a planning guide, on roads and trails the battery or platoon will average 25 kilometers (km) per hour in an open column and 10 km per hour in a close column (at night).

CHAPTER 3 BATTERY DEFENSE

This Chapter implements STANAG 2113, STANAG 2047/ QSTAG 183, and STANAG 2934, Chapter 13/QSTAG 503.

Section I INTRODUCTION

3-1. THREAT CAPABILITIES

The enemy will direct actions against the field artillery to suppress, neutralize, and/or destroy our capability to fight. All field artillerymen must know and apply passive and active defense measures against artillery, air, and ground attacks if they are to survive and provide continuous and responsive fire support.

a. Detection. The enemy will try to detect FA elements. Detection is done through the study of our doctrine and the processing of signals intelligence (SIGINT), imagery intelligence (IMINT), and human intelligence (HUMINT).

(1) Signals Intelligence.

(a) Using signal intercept and radio direction finding (RDF) equipment, the enemy collects various frequency modulated (FM) and amplitude modulated (AM) transmissions. Through triangulation, the enemy finds the signal. FM monitors are closer to the forward line of own troops (FLOT) because of the limited range of FM radios; AM radio direction finding monitors follow the front echelon. About 25 seconds after communications begin, the enemy targeting sequence can continue even if our communications stop. Within 2 to 3 minutes the information can produce a jamming mission, fire mission, or a combat mission. Tactical FM radios operating on low power can be picked up by enemy RDF units at distances in excess of 10 kilometers. High power signals can be detected at distances up to 40 kilometers. However, directional antennas will improve survivability.

(b) Other targeting means are radars, sound, and visual target detection teams. Radars can detect firing weapons within 100 meters or less. Higher trajectories produce more accurate results. Seismic and sound ranging can produce targets with a target location accuracy of 1 percent of range up to 10 km (error of 100 meters). However, their accuracy is diminished by other battle noise and they are affected by weather and the soil. Unaided

visual observations depend on line of sight and their accuracy varies. Visual, sound, and radar collectors are commonly organic to the front line units; and immediate targeting can be expected. About 10 percent of enemy detection of friendly artillery is by RDF; sound and flash provide about 20 percent and radar and/or visual assets provide the remaining 70 percent.

(2) Imagery Intelligence. This effort is normally coordinated, cued by other sensors. It consists of photographic electro-optical imagery, thermal detection, radar location, and laser imagery. The product from these sensors may require laboratory processing. Data may have to be transcribed to a map sheet during the analysis. The processing of IMINT requires no more than 2 hours. Target location errors from IMINT will be no more than 100 meters.

(3) Human Intelligence. Long range patrols, spies, partisans, and enemy prisoners of war (EPWs) are the HUMINT collectors. Although HUMINT relies primarily on visual observation, the peculiar equipment, predicted activities, bumper markings, spoils of the war, and rubbish that is left behind, add to the accuracy of the targeting effort.

b. Attack. A battery can be suppressed and destroyed by the following:

- Counterfire. Enemy attacks with up to 600 rounds fired into a 200- x 100-meter area (See FM 100-2-1, page 9-23).
- Air attack (high-performance aircraft and helicopters).
- Ground forces (mounted forces of tanks and motorized infantry; dismounted forces of infantry, airborne and/or air assault, and partisans and/or guerrillas).
- Radio electronic combat (REC). REC combines SIGINT, direction finding, intensive jamming, deception, and destructive fires to attack enemy organizations and systems.

3-2. BATTERY RESPONSIBILITIES

a. The BC is responsible for general planning, coordination, and execution of his battery defense. The BC analyzes the S2's IPB and develops an overall defensive plan. On the basis of the tactical situation, the BC must develop his own engagement area based upon avenues of approach, lines of intervisibility, and the expected threat. The BC must be able to conduct a modified terrain analysis of the position area and surrounding terrain to determine from where the enemy will attack. The BC must graphically portray to his leaders how he intends to defend his position. With this as a beginning, the platoon leader can develop a plan to defend his platoon. He will coordinate with his platoon sergeant for positioning of listening posts (LPs) and/or OPs, fighting positions, direct fire targets, target reference points, or range markers to direct the firepower of the platoon into the engagement area.

b. The first sergeant is responsible overall for the execution of battery defense. The first sergeant integrates the platoon defense plans into an overall battery defense plan. This may not be possible due to the distances platoons may be dispersed from each other. If this is the case, the 1SG will review both platoon defensive plans and forward them to battalion. He also will coordinate for resupply all Class IV material and support as necessary.

Note: In a USMC battery, the local security chief is overall responsible for the execution of battery defense.

c. Once the BC's time line and defensive priorities are established, the platoon leader will coordinate with the platoon sergeant to accomplish the following:

- Establish a rally point immediately upon occupation.
- Develop the platoon defensive plan.
- Supervise the defense forces.

- Direct and sight in the positioning and preparation of the following:
 - Crew-served weapons.
 - Antitank weapons.
 - Observation posts and/or listening posts.
- Ensure that communications are installed, checked, and functioning.
- Designate air TRPs.
- Select positions for TRPs and range markers.
- Organize and rehearse the reaction force.
- Ensure that unit members know equipment and/or material destruction procedures.
- Ensure that howitzer direct fire targets are established and integrated into overall defensive plan.
- Ensure that killer junior targets are computed by the FDC and distributed to each howitzer section and that each section chief knows how to compute 10/R.
- Ensure there is a plan for medical evacuation.

d. The section chief does the following:

- Ensures that the howitzer range card is prepared according to the sectors assigned by the platoon sergeant/1SG.
- Studies the route to and locations of alternate and supplementary positions.
- Ensures that the crew-served weapons range cards are prepared in accordance with assigned sectors.
- Ensures that individual and crew-served fighting positions are properly prepared and have overhead cover.

e. All battery leaders must become familiar with the defense plan, rehearse the plan, and brief their subordinates on its execution.

Section II

CONSIDERATIONS FOR DEFENSE

Note: Paragraph F-10 and Appendix H provide further guidance and checklists for battery defense.

3-3. USE OF TERRAIN

a. Camouflage. If it can be seen, it will be hit. If it can be hit, it will be killed. A battery that is concealed or cannot

be recognized has greatly increased its odds for survival. There are six factors of recognition: position, color, shape, shadow, texture, and movement. Following the principles of concealment (camouflage construction, light and noise discipline) helps the battery avoid detection.

(1) Use artificial camouflage. Two artificial camouflage measures that reduce the chance of recognition are pattern painting of equipment with the NATO three-color patterns and proper use of the lightweight screening system.

(2) Properly site electronic equipment to reduce signatures, and position all battery equipment to eliminate exposure and detection.

(3) Make use of all camouflage. Trees and shrubs can hide a battery or platoon. Built-up areas are great for hiding equipment, because man-made items look like other man-made items and do not contrast with natural surroundings.

(4) Use whatever terrain and natural concealment are available to blend into the surroundings.

(5) Maintain light and noise discipline.

(6) Use the track plan. The most common signs of military activity in an otherwise well camouflaged area are tracks, spoil, debris, and movement. The BC must enforce his track plan. Existing roads and trails must be used. If none are available, some should be created with heavy vehicles to give the appearance that a unit has moved through the area. The roads and trails must have logical starting and ending points.

b. Fortification.

(1) Occupy positions that have natural advantages for defense, such as interior tree lines and ravines.

(2) Harden battery positions and dig in whenever possible. FM 5-103 shows good examples of hardened positions.

(3) Whenever possible, construct obstacles to delay, stop, divert, or canalize an attack force. All obstacles should be covered by fire. Types of man-made obstacles and techniques for their employment are found in FM 5-103.

(4) In fast-moving situations, or when emergency displacement is anticipated, hardening might be limited to digging fighting positions on the perimeter, placing sandbags around sensitive equipment such as collimators and tires, and constructing individual shelters for prone personnel. Placing sandbags on or around the engine compartment and the ballistic shield improves survivability of the howitzer. If natural cover is limited or unavailable, individual fighting positions should be constructed. FM 7-7 gives instructions

on how to construct fighting positions, machine gun positions, range cards, and how to establish sectors of fire with crew-served weapons.

(5) Camouflage the spoil from position hardening.

3-4. DEFENSE IN DEPTH

Defensive operations should be planned so that the BC and platoon leaders are warned of an impending attack soon enough to displace the unit or defend the position. Maneuver forces operating in the same area can provide early warning of enemy attacks. The BC should talk to these elements. OPs and LPs are also key elements for early warning. When determining the location of the OPs and/or LPs, consider observation and field of fire, cover and concealment, obstacles, key terrain, avenues of approach, and METT-T. How far from the battery area OPs and LPs are located depends on terrain, visibility, likely threats, and how much time the battery requires to displace or occupy preselected fighting positions. Locate OPs to observe likely avenues of approach so the enemy can be engaged at long range with artillery, mortars, or close air support. Man OPs with at least a two-man team and provide them with antitank weapons, a map, binoculars, night vision goggles, food, water, and two means of communications. OPs must be able to quickly identify target reference points (TRPs) in avenues of approach and communicate to higher. OPs must be briefed on their responsibilities and the enemy situation.

3-5. SECURITY

The cannon battery/platoon is highly vulnerable to attack as it occupies or displaces from a position. The first order of business is establishing security. Due to personnel constraints, a unit may not be able to both fully man an effective defensive perimeter and provide continuous fire support. In accordance with the factors of METT-T, the commander may consider alternatives such as requesting an element from the supported maneuver unit, or "calling out" one of his sections to man the perimeter.

a. Upon occupying a position, each section must have a predetermined sector of responsibility. It must make maximum use of primary weapons and ensure there is a coordinated, all-around defense with interlocking fires. The defense plan includes defensive resources (see Table 3-1, page 3-4) and is visually depicted by a defense diagram (see Section III). The defense diagram is based on the data for each howitzer and each machine gun range card. It includes the fields of fire for grenade launchers, antitank weapons, and individual weapons. The diagram is prepared by the platoon sergeant and approved by the platoon leader. If howitzer sections are dispersed over great distances, the section becomes responsible for its defense. It must be able to defend itself until help arrives.

Table 3-1. Battery defensive resources

| MINES THAT MAY BE ALLOCATED TO A CANNON BATTERY | | | | |
|--|---|--|-------------------|---|
| Mine | Type | Range or Radius | | |
| M15 | Antitank | | | |
| M16 | Antipersonnel | 30 meters | | |
| M18 (Claymore) | Antipersonnel | 50 meters | | |
| M19 | Antitank | | | |
| M21 | Antitank | | | |
| Note: Source is FM 101-10-2. | | | | |
| WEAPONS THAT MAY BE AVAILABLE FOR MUTUAL SUPPORT | | | | |
| Weapons | Munitions | | | |
| Cannons (indirect fire) | DPICM, HE/VT, Q, smoke, illuminating, and FASCAM | | | |
| Attack helicopters | TOW, 2.75-inch rockets, MG, and 40-mm and 20-mm cannons | | | |
| USAF tactical air | Guns, bombs, rockets, napalm, missiles (Mavericks), guided bombs, and cluster bombs (all varieties) | | | |
| Mortars | HE, WP, and illuminating | | | |
| Naval gunfire | Armor piercing, HE/VT, Q, CP, and illuminating | | | |
| NUMBER OF NIGHT OBSERVATION DEVICES IN FIRING BATTERIES | | | | |
| Device | 105-mm Battery | 155-mm Towed Battery | 155-mm SP Battery | |
| AN/PVS-7B (night vision goggles) | 6 | 6 | 6 | |
| AN/PVS-5 (night vision goggles) | 6 | 6 | 6 | |
| AN/PVS-4 (night vision sight, tripod mounted) | 4 | 4 | 4 | |
| WEAPONS ASSIGNED TO A CANNON BATTERY | | | | |
| Weapon | Issue or Caliber | Max Effective Range | Reference | Notes |
| M16A2 | One per individual | 800 meters | FM 23-9 | May select fully automatic or semiautomatic fire |
| M203 grenade launcher | Per TOE | 400 meters (area); 200 meters (point) | FM 23-9 | M433 HEDP excellent against personnel carrier |
| M60 light MG: Tripod mounted | Per TOE | 1,100 meters (600 meters [grazing]) | FM 23-65 | |
| Air defense | | 325 meters | FM 23-67 | |
| M2 heavy barrel (50 cal): Tripod mounted Ring mounted Air defense | One or two per howitzer section (SP) | 2,430 meters (area); 1,800 meters (point) 1,500 meters (area); 1,000 meters (point) 725 meters | | Best used on tripod with traverse and elevating mechanism |

Table 3-1. Battery defensive resources (continued)

| Weapon | Issue or Caliber | Max Effective Range | Reference | Notes | | | | | | | | | | | | | | | | | | | | |
|--|--|--|---|----------------------------------|---------------------------------|-----------------------------|----------------|------------------|---------------|-----------|-------------------------------|------------|--|-----------------------|--------------------------------------|---|---------------------|--------------------------------|---|---------------------------|------------------------------------|-----------------------|------------------------------|--|
| M72A2 LAW: Target stationary Target moving AT-4 | Issued as ammunition | 250 meters 100 meters 500 meters | FM 23-33 | Used in pairs | | | | | | | | | | | | | | | | | | | | |
| Cannons: Direct fire (AP) Killer Junior (HE/T) APERS M546 Direct fire (antitank) HE/Q HEP, M327 Stinger Surface-to-air Vulcan | 155-mm 155-mm 105-mm 155-mm/105-mm 105-mm 105-mm Multibarrel 20-mm cannon | Minimum reliable range 500 meters + Muzzle + (See TM on weapon system) (See TM on weapon system) (See TM on weapon system) Excess of 3,000 meters 1,200 meters | App I FM 44-18 FM 44-3 FM 101-52-6 | Teams assigned from battalion | | | | | | | | | | | | | | | | | | | | |
| LEGEND | | | | | | | | | | | | | | | | | | | | | | | | |
| <table border="0"> <tr> <td>AP = antipersonnel (also APERS)</td> <td>LAW = light antitank weapon</td> </tr> <tr> <td>app = appendix</td> <td>MG = machine gun</td> </tr> <tr> <td>cal = caliber</td> <td>Q = quick</td> </tr> <tr> <td>CP = concrete-piercing (fuze)</td> <td>T = tracer</td> </tr> <tr> <td>DPICM = dual-purpose improved conventional munitions</td> <td>TM = technical manual</td> </tr> <tr> <td>FASCAM = family of scatterable mines</td> <td>TOW = tube-launched, optically tracked, wire-guided missile</td> </tr> <tr> <td>HE = high explosive</td> <td>USAF = United States Air Force</td> </tr> <tr> <td>HEAT-T = high-explosive antitank—tracer</td> <td>VT = variable time (fuze)</td> </tr> <tr> <td>HEDP = high-explosive dual-purpose</td> <td>WP = white phosphorus</td> </tr> <tr> <td>HEP = high-explosive plastic</td> <td></td> </tr> </table> | | | | | AP = antipersonnel (also APERS) | LAW = light antitank weapon | app = appendix | MG = machine gun | cal = caliber | Q = quick | CP = concrete-piercing (fuze) | T = tracer | DPICM = dual-purpose improved conventional munitions | TM = technical manual | FASCAM = family of scatterable mines | TOW = tube-launched, optically tracked, wire-guided missile | HE = high explosive | USAF = United States Air Force | HEAT-T = high-explosive antitank—tracer | VT = variable time (fuze) | HEDP = high-explosive dual-purpose | WP = white phosphorus | HEP = high-explosive plastic | |
| AP = antipersonnel (also APERS) | LAW = light antitank weapon | | | | | | | | | | | | | | | | | | | | | | | |
| app = appendix | MG = machine gun | | | | | | | | | | | | | | | | | | | | | | | |
| cal = caliber | Q = quick | | | | | | | | | | | | | | | | | | | | | | | |
| CP = concrete-piercing (fuze) | T = tracer | | | | | | | | | | | | | | | | | | | | | | | |
| DPICM = dual-purpose improved conventional munitions | TM = technical manual | | | | | | | | | | | | | | | | | | | | | | | |
| FASCAM = family of scatterable mines | TOW = tube-launched, optically tracked, wire-guided missile | | | | | | | | | | | | | | | | | | | | | | | |
| HE = high explosive | USAF = United States Air Force | | | | | | | | | | | | | | | | | | | | | | | |
| HEAT-T = high-explosive antitank—tracer | VT = variable time (fuze) | | | | | | | | | | | | | | | | | | | | | | | |
| HEDP = high-explosive dual-purpose | WP = white phosphorus | | | | | | | | | | | | | | | | | | | | | | | |
| HEP = high-explosive plastic | | | | | | | | | | | | | | | | | | | | | | | | |

b. The PSG or platoon leader will assign supplementary positions and ensure that they are depicted on the defense diagram. These positions will reinforce the primary position and allow the unit to perform specific missions such as direct fire. The signal to occupy supplementary positions will be disseminated throughout the unit and the movement to those positions should be rehearsed by the platoon leader and platoon sergeant with all howitzer sections.

c. If the platoon is attacked or penetrated by enemy forces, the reaction force will respond by assembling at the predetermined location to:

- Assess the situation and deploy to augment the existing perimeter.
- Deploy using fire and maneuver to expel and/or destroy the enemy.
- Notify the FDC/BOC of the situation as it develops.
- Re-establish the perimeter.

d. A suggested composition of the reaction force is as follows:

- Reaction force NCO in charge; for example, the platoon sergeant.
- One man per howitzer section.
- One man from the fire direction center or POC.
- One man from the communications section (if available).
- One man from the maintenance section (if available and in position).

Note: This is only a guide; actual SOP may be different. The battery may also consider making one howitzer section the reaction force. This ensures that there is an NCO in charge and that the force does not have to assemble to be effective; that is, they are already assembled.

3-6. DISPERSION

Dispersion minimizes the effects of an air attack or a counterfire attack. When using this technique, units should disperse, as a minimum, over a 200 by 400 meter area with howitzers no closer than 100 meters apart. The FDC should be positioned approximately 100 meters from either flank howitzer. Figure 3-1 shows a platoon position with elements not dispersed. Figure 3-2 shows a platoon position with elements dispersed. Dotted lines in both figures indicate the area normally covered by enemy counterfire.

Note: With the use of the BCS, and LCU, howitzers can be accurately located over a widely dispersed area of operation. Refer to Chapter 2 for further discussion of weapons dispersion.

3-7. PRIORITIES

a. The BC or platoon leader may be instructed to continue his mission in the position despite hostile counterfire. In that case, he might establish the following tasks in the priority indicated:

- Harden critical items of equipment.
- Prepare individual fighting positions.
- Prepare defensive positions.
- Select alternate positions, displacement routes, and a signal in case movement is unavoidable. Brief key personnel on this information.
- Camouflage.

b. The BC or platoon leader may be instructed to displace upon receiving fire. In that case, he would have a different list in mind. For example, he might establish the following tasks to be done before receiving incoming fire:

- Camouflage.
- Prepare limited protection for personnel and equipment.
- Reconnoiter and/or select alternate positions, displacement routes, and march-order signal.
- Prepare alternate positions.

- Prepare defensive positions.
- Improve individual protection.
- Improve equipment protection.

c. The duties of the section members may be different if they are ordered to continue the mission or displace on receiving fire. Tables 3-2 and 3-3 (page 3-8) are samples of duty breakdowns. Actual work priorities should be included in unit SOPs.

3-8. DEFENSE IN ALL DIRECTIONS

The enemy can attack from any direction; so the platoons must be able to defend in all directions. Based upon METT-T, the unit may consider dispatching patrols to maintain security. Refer to FM 7-8 for specific instructions on the conduct of patrols.

3-9. MUTUAL SUPPORT

Mutual support is one unit helping another unit or one soldier helping another soldier. Battery and/or platoon defensive fire plan targets should be submitted to the battalion FDC and updated as needed. Reports of any type of enemy attack should be forwarded to the battalion as soon as possible after contact is made to use mutual support. Within the platoon, one section must be ready to support another section. Apply the same concept to the individual soldier and you can build a formidable defense. Range cards for crew-served weapons are essential to a good defense. The BC or platoon leader should plan indirect fire targets for the defense of his position. These might include illumination targets if self-illumination is not possible.

3-10. CONTROL

All leaders must control their personnel and firepower before, during, and after an attack so the correct actions can be taken at the right time. Battery leadership should review FM 71-1 for techniques of focusing and controlling fires. Something as simple as what sections will suppress with heavy machine guns, as others direct fire their howitzers, will be difficult to control without rehearsing. The use of range markers out to 1,500 meters or TRPs greatly enhances the effectiveness of massing the fire power in a platoon or battery. Battery and platoon SOPs must be developed and followed to maintain control.

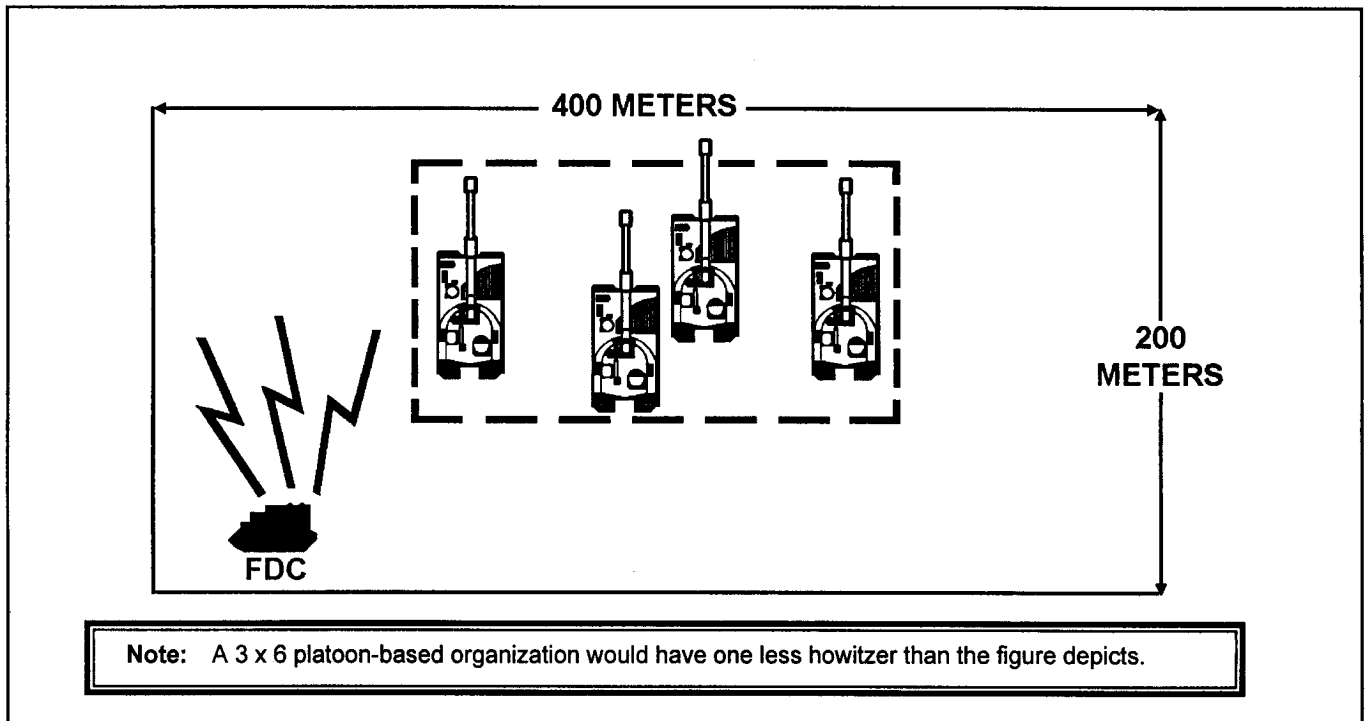

Figure 3-1. Platoon position, elements not dispersed

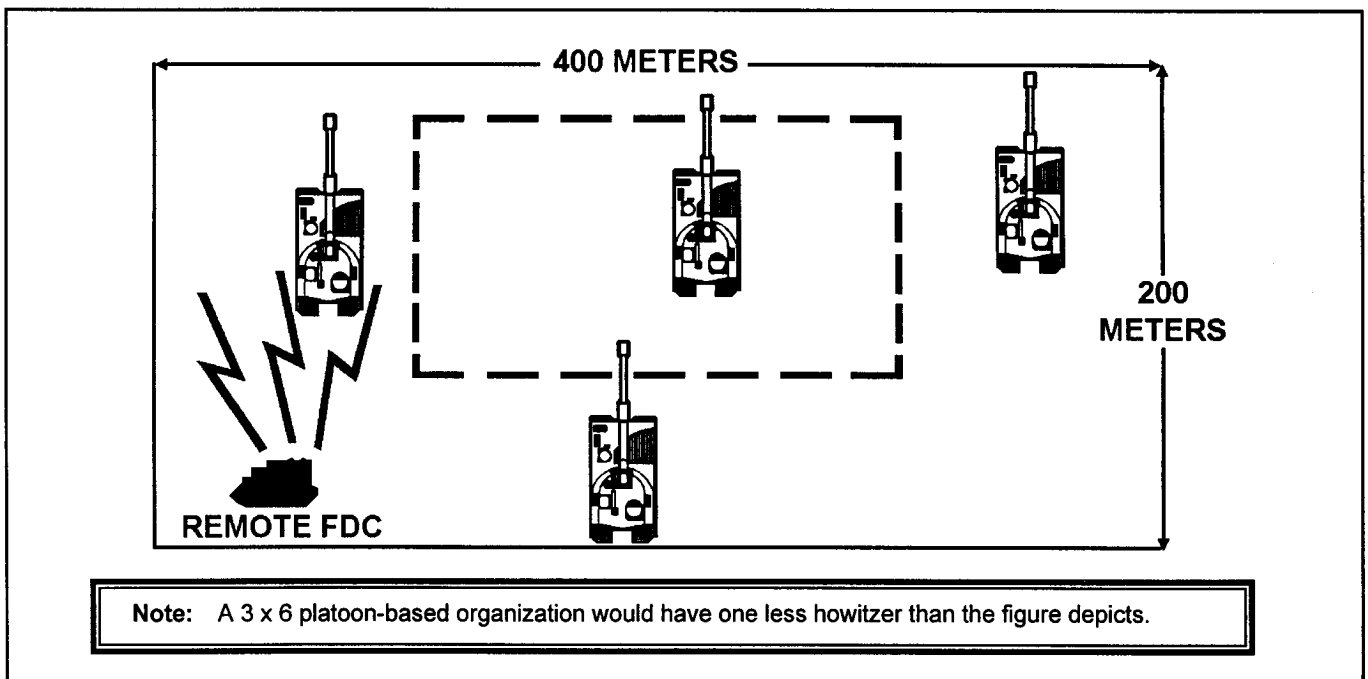

Figure 3-2. Platoon position, elements dispersed

3-11. FLEXIBILITY

No tight will ever go exactly as planned, so the BC and platoon leaders must respond quickly to the unexpected.

They must constantly evaluate METT-T and be prepared to deal with situations that are not in the plan.

Table 3-2. Sample duties assigned (unit to maintain present position)

| SECTION CHIEF | GUNNER | ASSISTANT GUNNER | SECTION MEMBERS | DRIVER |
|---|--|---|--|---|
| <p>Prepare range card</p> <p>Brief personnel on displacement route(s), alternate position, and signals to be used.</p> <p>Supervise at supplementary position; assign members to ¹ crater analysis team.</p> <p>Take cover, mask and/or vest, and man defensive positions as necessary.</p> <p>Continue the mission.</p> | <p>Sandbag the collimator.</p> <p>Help with camouflage.</p> <p>Continue to improve camouflage.</p> | <p>Install camouflage net.</p> <p>Continue to improve camouflage; for example, use natural vegetation.</p> <p>Prepare supplementary position.</p> | <p>Harden critical items of equipment with sandbags (M992, all truck tires, and so forth.)</p> <p>Prepare individual and defensive positions.</p> <p>Selected members prepare supplementary positions.</p> | <p>Bury the wire.</p> <p>Become familiar with displacement route(s).</p> <p>Help at supplementary position.</p> |
| <p>¹ Crater analysis data should be reported by use of the shelling report (SHELREP), bombing report (BOMREP), rocketing report (ROCKREP), or mortar bombing report (MORTREP) format outlined in FM 6-121 and STANAG 2008.</p> | | | | |

Table 3-3. Sample duties assigned (unit allowed to displace)

| SECTION CHIEF | GUNNER | ASSISTANT GUNNER | SECTION MEMBERS | DRIVER |
|---|--|---|--|---|
| <p>Prepare range card</p> <p>Brief personnel on displacement route(s), alternate position, and signals to be used.</p> <p>Supervise preparation of individual and defensive position.</p> <p>Take cover; mask and/or vest as necessary.</p> <p>Continue the mission while awaiting signal to displace.</p> <p>Displace as per prior instructions.</p> | <p>Sandbag the collimator.</p> <p>Supervise preparation of alternate position.</p> <p>Supervise improvement of equipment protection.</p> | <p>Install camouflage net, and improve with vegetation.</p> <p>Continue to improve camouflage.</p> <p>Help at individual and defensive positions.</p> | <p>Help with camouflage.</p> <p>Selected members continue camouflage and prepare alternate position.</p> | <p>Bury the wire.</p> <p>Become familiar with displacement route(s).</p> <p>Help at supplementary position.</p> |

Section III

DEFENSE DIAGRAM

3-12. PURPOSE

The defense diagram graphically portrays the position area with respect to the azimuth of fire. The diagram shows the position area, all section positions, all defensive positions (including sectors of fire, TRPs, and adjacent units), and key terrain. It is a key tool to ensure there is a defense plan which can provide 6,400-mil coverage (if necessary) for the battery. Also, this diagram is sent to battalion and is used to develop a battalion defensive fire support plan.

3-13. CONSTRUCTION OF THE DIAGRAM

There are different methods for determining the location of different points for the defensive diagram and constructing the corresponding grid sheet. The LCU or BCS can simplify the process of determining grid coordinates and altitude of positions in and around the platoon or battery area. Computations can be made by using the piece location format. (See ST 6-40-31 or the applicable job aids for the steps.)

a. Constructing the Matrix. There are different methods of constructing a matrix on which to draw your diagram. The key is to pick a scale for your casting and northing grid lines which will enable you to plot all or most of the desired locations. The FDC section has preprinted grid sheets which are scaled to 1:25,000. Each grid square represents 1,000 meters on these sheets. Examples of the scale interval you could choose are as follows:

- 1:12,500—Each grid square represents 500 meters.
- 1:5,000—Each grid square represents 200 meters (Figure 3-3, page 3-10).

b. Constructing the Diagram. The steps to construct a platoon diagram could be as follows:

- Construct the matrix (Figure 3-4, page 3-11).
- Add terrain features including dead space.
- Draw the azimuth of fire to orient the diagram.
- Plot the required positions (such as howitzers, TRPs, FDC or POC, LPs or OPs, crew-served weapons, tank killer team positions, and Killer Junior targets). Use the grid coordinates obtained from the BCS, LCU, PLGR, or from a map spot.

- Draw sectors of fire for howitzers and crew-served weapons (Figure 3-5, page 3-12).
- Record the related information and grids on the back of the defensive diagram (Figure 3-6, page 3-13).
- Verify that the defense diagram depicts the BC's defensive plan and that it graphically portrays the range card data to include TRPs, avenues of approach, and so on. (See Figure 3-6, page 3-13.)

3-14. DISPOSITION OF THE DIAGRAM

Based upon guidance from the BC or 1SG, the GSG begins to construct the defensive diagram during the advance party operations. Once the main body occupies the new position, the GSG gives the platoon sergeant (platoon-based) or 1SG (battery-based) the diagram to be completed or to be checked and verified. If the battery is a platoon-based unit, the 1SG will collect both platoon diagrams and integrate them into the battery defensive diagram. The battery diagram is then sent to the battalion TOC for further consolidation.

3-15. PREPARING RANGE CARDS

a. The platoon sergeant establishes the sectors of fire for the crew-served weapons. When these sectors have been determined and assigned, a range card will be constructed in duplicate, for each primary position. A range card will be partially completed for each alternate and supplementary position. Range cards are continually updated and revised throughout the occupation of the position. Platoon or battery TRPs must be on range cards. This allows the battery leaders the ability to control and mass direct fire assets. The battery leaders must verify the proper construction of all range cards.

(1) **Howitzer range card.** The DA Form 5699-R (Howitzer Range Card) consist of two parts. A sketch of the sector of fire depicts targets and reference points. A data section lists data necessary to engage targets during periods of limited visibility. Procedures for completing DA Form 5699-R are as follows:

(a) Having been assigned a sector of fire, begin a sketch of the area. Depict left and right limits and potential targets and/or reference points in the SECTORS OF FIRE section. Identify the targets and/or reference points in your sketch by numbering them in order from the most probable to the least probable.

(b) While sighting along the bottom of the bore, direct the gunner to traverse and the assistant gunner to elevate or depress until the weapon is sighted on the left limit. Direct the gunner to turn the head of the pantel, without moving the tube, onto the collimator (or primary aiming point) and to read the deflection (df) from the reset counter (or azimuth and azimuth micrometer

scales). Record this deflection on the range card in the space marked LEFT DF. If the left limit is also a target, record the deflection in the DF column on the appropriate line for the target number. Direct the assistant gunner to measure the quadrant and record the quadrant. Complete the DESCRIPTION column by annotating a brief description of the target.

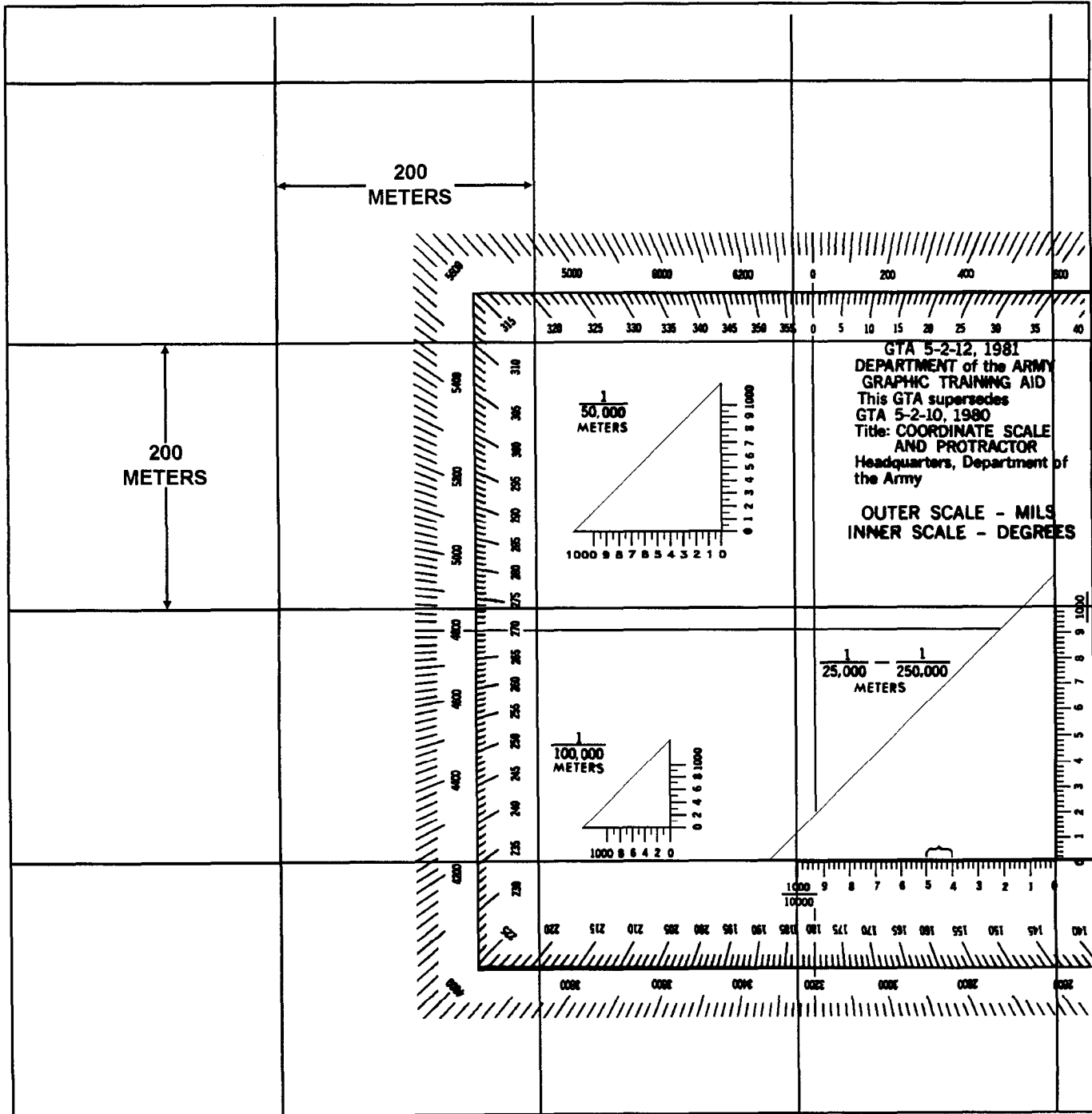

Figure 3-3. Defense diagram matrix with a scale of 1:5,000

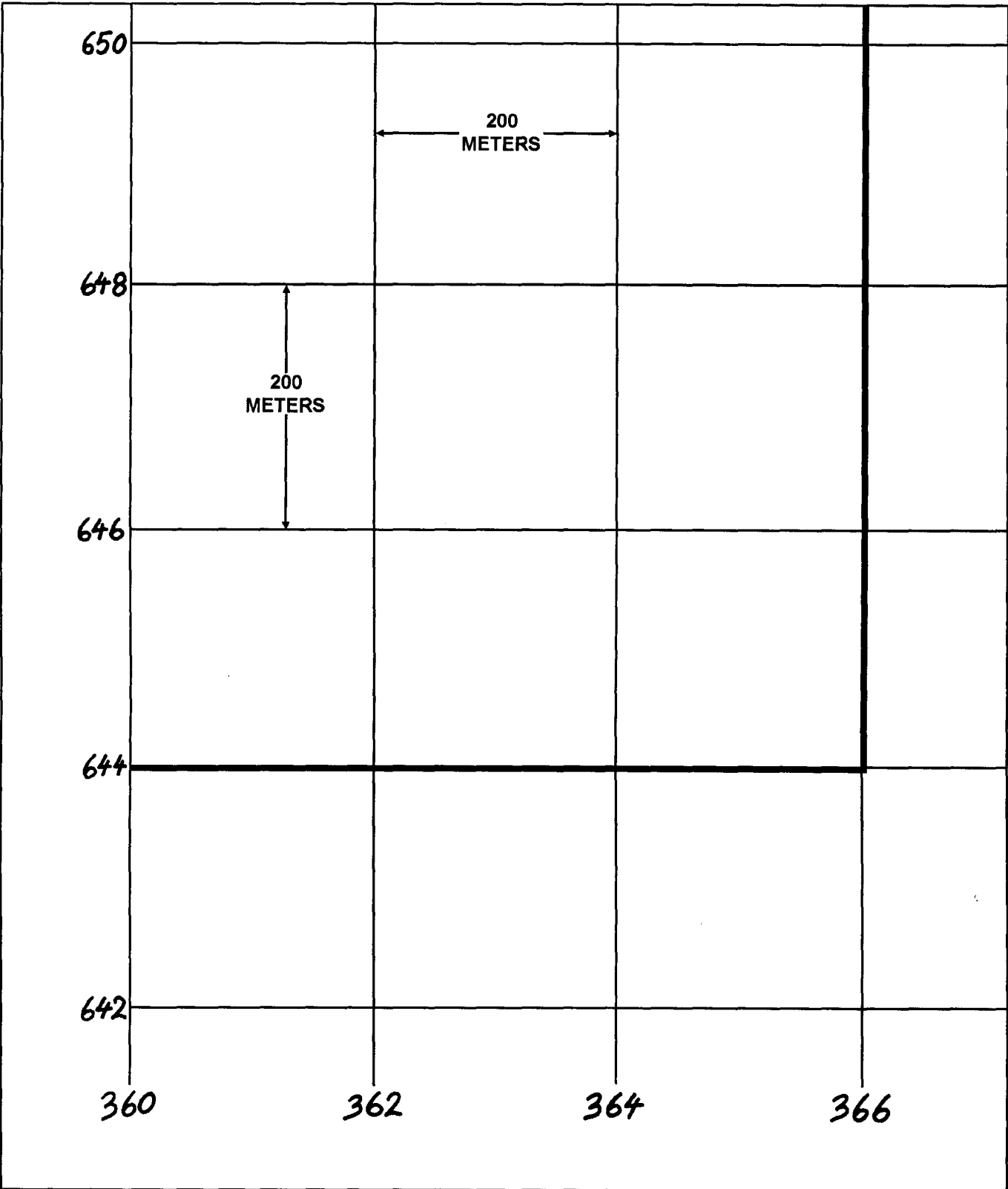

Figure 3-4. Constructing the matrix

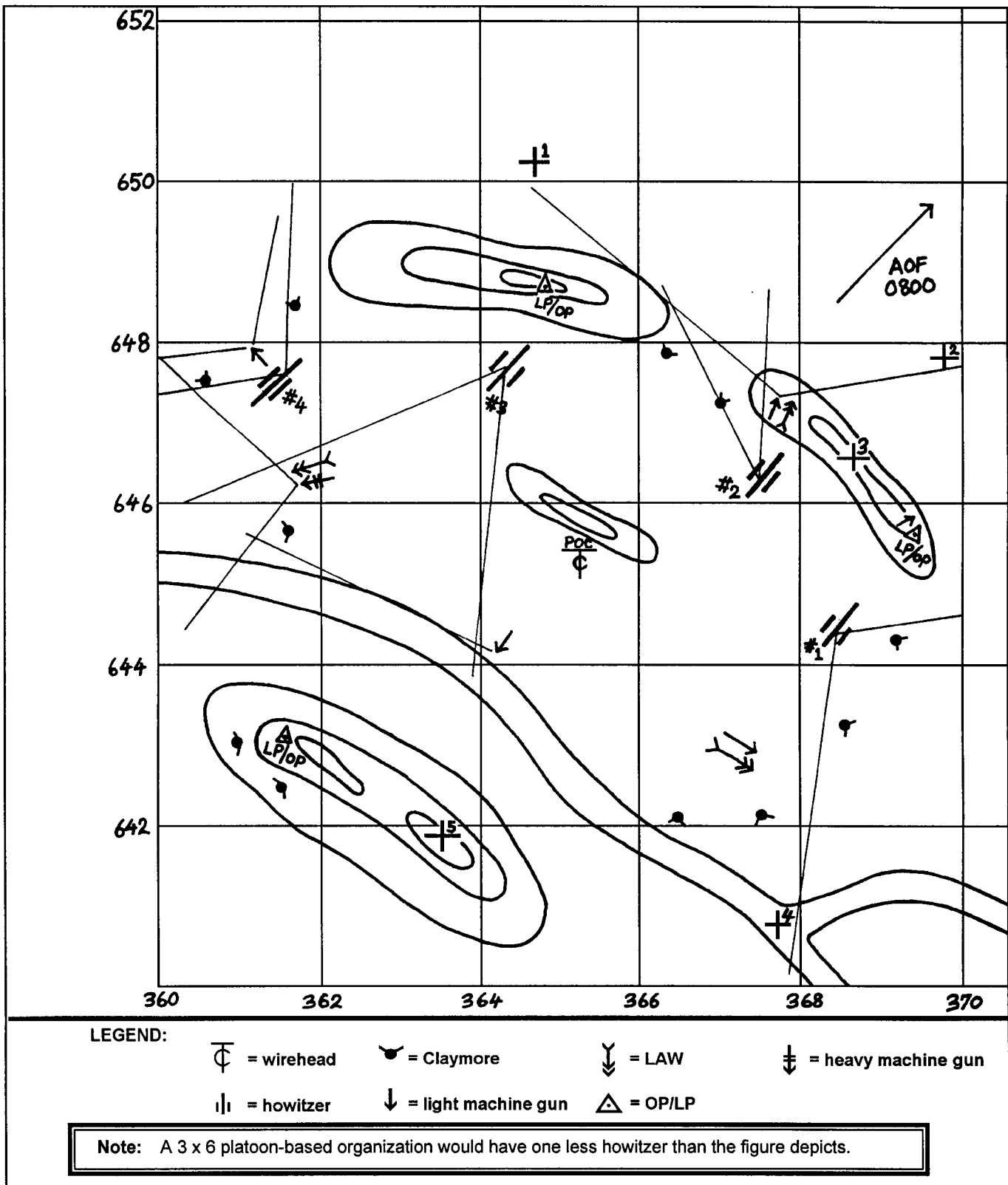

Figure 3-5. Defense diagram (scale 1:5,000) for a platoon

UNIT: 1/A/2-81 FA
 DATE: 09/08/90
 SCALE: 1:5,000

PLT FIRE SPT DEFENSIVE TGTs

| GRID | ALT | DESCRIPTION | REMARKS |
|-------------|-----|-------------|------------------|
| 1-3647 6504 | 400 | DEAD SPACE | KILLER JUNIOR #3 |
| 2-3698 6478 | 400 | DEAD SPACE | KILLER JUNIOR #1 |
| 3-3687 6468 | 450 | HILLTOP | HE/Q |
| 4-3677 6408 | 400 | RJ | DPICM |
| 5-3635 6419 | 470 | HILLTOP | HE/Q |
| | | | |
| | | | |
| | | | |

AIR DEFENSE STINGER/AVENGER TEAM LOCATED AT GD 388642

LEGEND:

alt = altitude spt = support
 RJ = road junction tgt = target

Figure 3-6. Related information

(c) Repeat these procedures for the right limit and for all target reference points. Determine the shell, charge, and fuze to be fired for each target and record that information in the appropriate columns. Use the REMARKS column to indicate additional information needed to engage the target; for example, sweep 200.

(d) The measured quadrant and range should be given to the FDC to be converted into a true quadrant. Then record the true quadrant on the range quadrant in the QE column.

(e) When the range card is completed (example in Figure 3-7), make a duplicate card for the platoon sergeant. Continue to update and review the range card throughout occupation of the position.

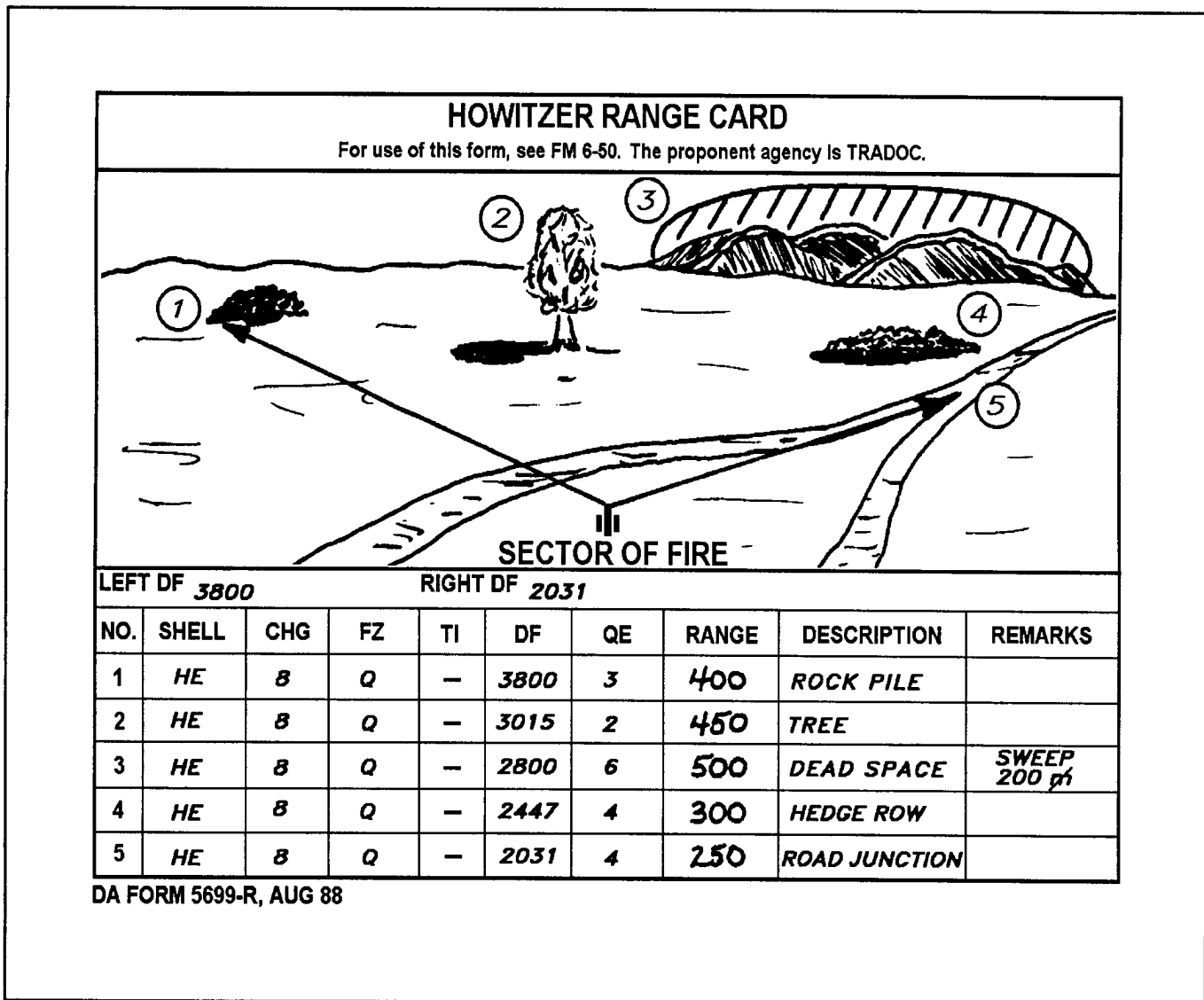

Figure 3-7. Howitzer range card

(2) Machine gun range card. The machine gun range card consists of two parts: a sketch of the sectors of fire and a data section that list data necessary to engage targets during periods of limited visibility. The sketch depicts the primary and secondary sectors of fire, the location of the weapon, azimuths of the left and right limits and/or the final protective line, target reference points, and any dead space. A sample is shown in Figure 3-8.

Note: A reproducible copy of DA Form 5699-R is at the back of this manual. For additional examples of completed range cards and a reproducible copy of DA Form 5517-R, see FM 7-8.

STANDARD RANGE CARD

For use of this form see FM 7-7J. The proponent agency is TRADOC.

| | | |
|---|---|--------------------|
| SQD <u>1st</u> PLT <u>1st</u> CO <u>B</u> | May be used for all types of direct fire weapons. | MAGNETIC NORTH |
|---|---|--------------------|

DATA SECTION

| POSITION | | DATE 22 MAY | | |
|----------------------|----------------------|--------------------------------------|------------|----------------------|
| WEAPON M60 MG | | EACH CIRCLE EQUALS 100 METERS | | |
| NO. | DIRECTION DEFLECTION | ELEVATION | RANGE | AMMO DESCRIPTION |
| 1 | L 4600 | | | PDF |
| 2 | L 3800 | | | L DIRECTION |
| 3 | R 5900 | | | R DIRECTION |
| 4 | R 4880 | | 350 | ROAD JUNCTION |
| 5 | L 4050 | | 750 | LARGE TREE |
| 6 | R 5100 | | 800 | OLD CHURCH |
| REMARKS | | | | |

DA FORM 5517-R, FEB 86

Figure 3-8. Machine gun range card

b. Once the range cards are collected by the platoon sergeant, they are used in constructing the sectors of fire on the defense diagram. The result is a completed defense diagram with all pertinent data for the platoon defense (Figure 3-9).

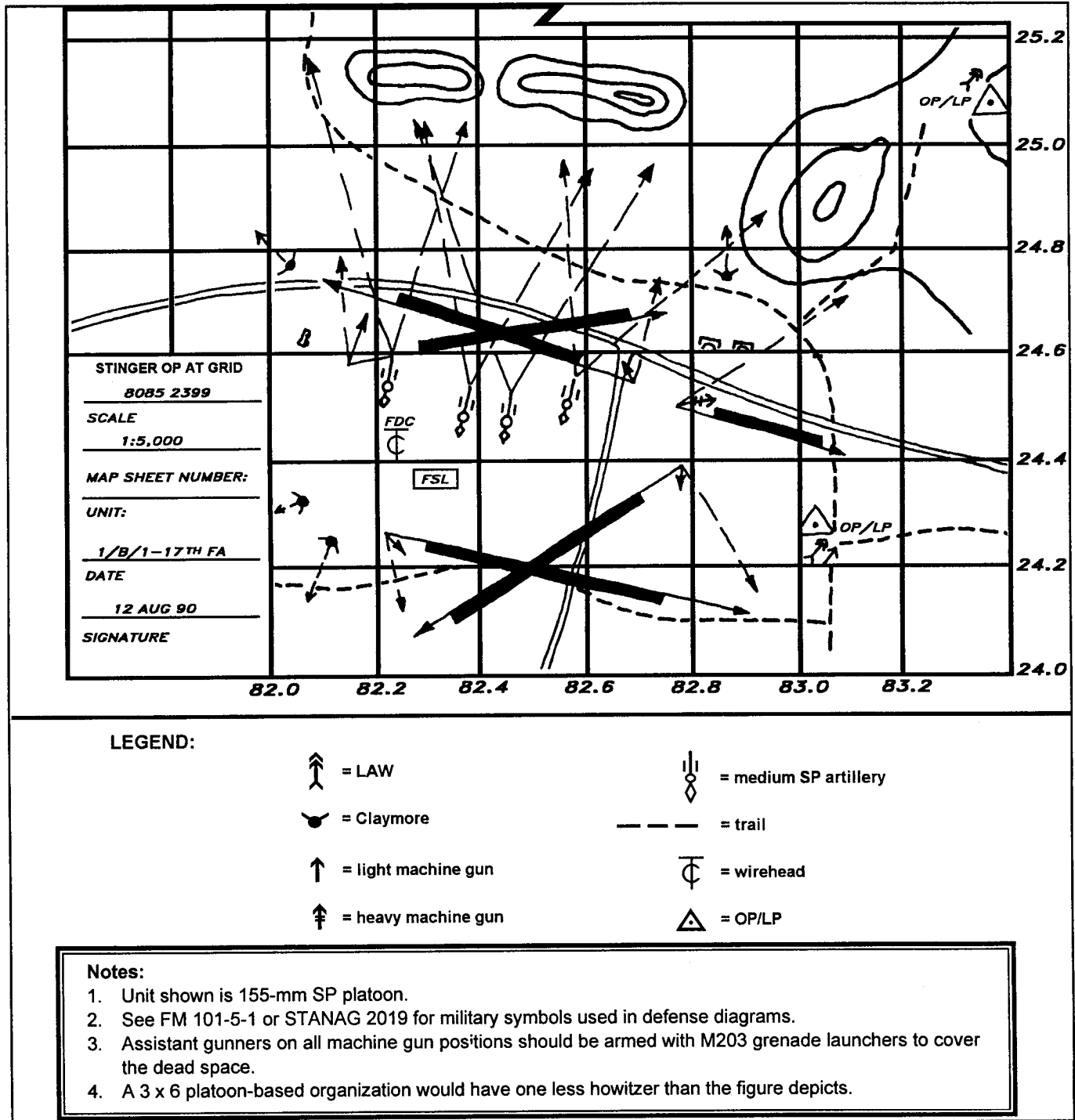

Figure 3-9. Completed defense diagram

Section IV

CONDUCT OF THE DEFENSE

3-16. DEFENSE AGAINST ENEMY ARMOR/MECHANIZED FORCE

a. If an enemy armor or mechanized force detects the battery or its platoons, the enemy can be expected to take the following actions:

(1) Tanks may assault in an attempt to breach or overrun the firing battery positions.

(2) Threat assault vehicles will maneuver to good standoff fighting positions to fire antitank guided missiles (ATGMs), direct fire cannons, and crew-served machine guns.

(3) These actions will be followed by a hasty mounted or dismounted attack through the battery area.

b. The preferred defense against a armor or mechanized ground attack is for the battery or platoon to move to a position from which it can continue the fire support mission (alternate position) without a direct confrontation with the enemy. However, in some circumstances fighting an enemy mechanized force may be unavoidable. Some combat-proven rules for fighting mechanized forces are as follows:

(1) Separate the infantry from the tanks.

(2) Slow down the tanks. Use smoke mixed with HE to obscure the enemy's vision and keep tanks buttoned up.

(3) Canalize tanks into predetermined engagement areas by using obstacles and fire support means.

(4) Use antitank weapons. (Rehearse tank-killer teams.)

Direct fire engagements must be controlled. The unit SOP must address who controls the fires, how to control the fires, and how to mass the direct fire assets. Units may consider self-illumination during periods of limited visibility.

3-17. DEFENSE AGAINST AIR ATTACK

a. The primary way for an FA battery to survive when the enemy has air parity or superiority is to be so well concealed that an enemy cannot detect the battery as a target. If the battery is detected and attacked, the key to survival is dispersion and engaging attacking aircraft with a large volume of fire. Immediate actions against air attack are as follows:

(1) The warning signal for an imminent air attack is given. (See paragraph 3-23).

(2) Every soldier takes cover and prepares to return fire.

(3) All weapons in the battery are used to return fire. Accuracy is not as important as mass (see Figure 3-10).

(4) A lead equal to two football fields should be used for fast-moving aircraft. A lead of one-half of a football field is used for slow moving aircraft (helicopters).

(5) Ring-mounted machine guns (.50 caliber) are the only organic air defense weapons in the battery. Primary or supplementary positions selected by the battery should be occupied by vehicles with ring-mounted weapons (M992) to return fire.

(6) Stinger and/or Avenger teams from the division or corps air defense battalion engage enemy aircraft. If available these teams should be positioned to cover primary low-flight avenues of approach into the battery area. Reference points for engaging enemy aircraft should be planned and their location disseminated throughout the unit. These can be terrain features or TRPs established for ground defense. The battalion S2 can aid in determining the likely enemy air avenues of approach for defense planning purposes. The reaction drill to counter an enemy air attack should be rehearsed thoroughly.

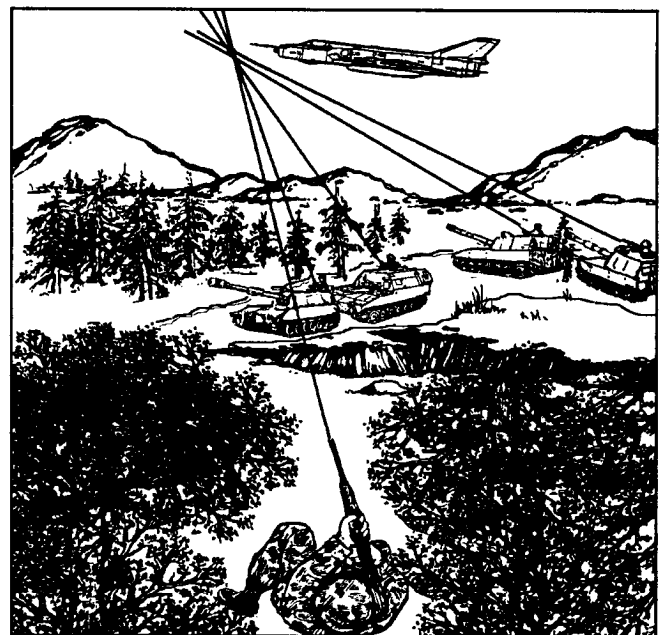

Figure 3-10. Mass battery fires against an air attack

(7) Antitank weapons are very effective against low flying rotary-winged aircraft at short ranges.

b. Defense of convoys against air attack is as follows:

(1) Move the battery at night, on concealed routes, or during periods of reduced visibility.

(2) Consider infiltration if there is a significant air threat.

(3) Post air guards for each vehicle, and assign sectors of responsibility that permit massing small-arms fires.

(4) Immediate action against air attack is to disperse vehicles. Everyone must return fire.

(5) Designated drivers must have strip maps to the battalion station and alternate medical facilities in the area; rehearse the plan.

c. For the employment of the Stinger and/or Avenger teams, see FM 44-18 and FM 44-23-1.

3-18. DEFENSE AGAINST DISMOUNTED ATTACK

a. Dismounted enemy elements will attack by use of the following:

- Ambushes.
- Guerrilla-type attacks (normally not exceeding platoon size and often conducted at night or in adverse weather).
- A diversionary attack and then a main attack.
- Dismounted infantry.

b. A properly equipped 10-man enemy combat patrol can effectively neutralize a cannon battery that is weak in its defense planning or execution. To keep this from happening, the battery must do the following:

- Fight the enemy outside the position.
- Insure fighting positions provide interlocking sectors of fire around the position.
- Use an overwatch technique. One element will cover the movement of another if defense personnel must withdraw to alternate positions.
- Chase the enemy with artillery fires when he is beaten back. Do not dispatch forces to chase him.
- Use mines, barbed wires, and other obstacles.
- Plan Killer Junior on dismounted avenues of approach.

c. An additional defense against a ground attack (mounted or dismounted) is for the battery or platoon to displace to an alternate position.

3-19. DEFENSE IN OPERATIONS OTHER THAN WAR (OOTW)

The battery could be involved in any number of possible contingency missions, to include OOTW. This is particularly true of artillery units that support light forces. The specifics of battery defense in OOTW depend largely on the situation. Also, they are largely determined by the equipment and offensive capability of the threat. In most situations, the threat consists of paramilitary or guerilla forces with minimum heavy weapons, armor, or air support. The primary ground threat to the battery is dismounted attacks by light infantry or infiltration by sappers or saboteurs. In this situation, the best defensive solution is consolidation of battery elements into a strong defensive perimeter, often called a fire base. For additional information on fire base operations and OOTW, see paragraph F-9 and F-10.

3-20. DEFENSE AGAINST INDIRECT FIRE

Counterfire continues to be the greatest threat facing the artillery. Dispersion, hardening, and movement are techniques used to survive the counterfire threat; but those techniques should not be used in isolation.

a. Dispersion is the least expensive method in terms of effort and time. Platoon installations, howitzers, fighting positions, and so forth should be no closer than 50 meters from each other, should not be on line, and should present a deceptively larger element.

b. If the ground threat or the terrain makes wide dispersion of the battery or platoon elements impractical, hardening the position will greatly increase survivability. Fighting positions with adequate overhead cover for crew-served weapons and individual soldiers must be prepared and continuously improved. Gun pits for towed howitzers, and hull-defilade positions for self-propelled weapons substantially increase the ability of the unit to survive and continue the mission.

c. Unplanned movement to an alternate position denies the maneuver force the amount of FA support it requires; it may increase the number of casualties. The point is, do not move unless your position is untenable.

3-21. DEFENSE AGAINST NBC ATTACK

The BC must ensure that the unit SOPs give procedures for dealing with NBC attacks. SOPs should cover chemical and radiological survey teams, protective measures, immediate action, decontamination, and reporting. Guidance for the commander is provided in FM 3-100.

3-22. EQUIPMENT AND MATERIEL DESTRUCTION PROCEDURES

The BC must ensure that the unit SOPs include the procedures for the destruction of unit equipment and material. He designates personnel to perform the destruction and ensure that adequate emergency destruction (ED) material is available. See DA Pamphlet 25-30, appropriate equipment technical manuals, and STANAG 2113 for guidance in preparing unit SOPs. The applicable details from STANAG 2113 are shown below.

* * * * *

EXTRACT
FROM STANAG 2113 (Edition 5)
DENIAL OF A UNIT'S MILITARY EQUIPMENT AND SUPPLIES TO AN ENEMY

* * * * *

AGREEMENT

2. Participating nations agree that:

- a. An enemy should be denied use of military equipment and supplies of allied forces.
- b. The denial to the enemy should, if possible, not preclude the later use by allied forces.
- c. The destruction of military equipment and supplies will only be ordered when their falling into enemy hands cannot be prevented; food and water may be destroyed or removed, but must not be polluted.
- d. After commencement of hostilities, in a tactical emergency, and provided that forces have passed to NATO operational command or control, a NATO commander may order the denial of a unit's military equipment and supplies.
- e. The denial of military equipment and supplies to prevent their use by the enemy is the responsibility of the user.
- f. The provision of instruction and means for, and training in, the denial of military equipment and supplies is a national responsibility.
- g. For the purpose of this agreement, the denial will be accomplished by means of destruction, immobilization, removal and/or pollution. If possible, when multiple same type weapons systems or equipment are to be destroyed or immobilized, identical components are to be destroyed or removed to prevent re-assembly of the weapon system or equipment by the enemy.

DEFINITIONS

3. The following terms and definitions are used for the purpose of this agreement:

- a. Denial. To prevent the enemy use of a units military equipment and supplies by means of destruction, removal or pollution.
- b. NATO Commander. A military commander in the NATO chain of command (AAP-6).

- c. Unit. Any military element whose structure is prescribed by competent authority, such as a table of organization and equipment; specifically, part of an organization (AAP-6).
- d. Unit's Military Equipment and Supplies. This includes unit facilities and installations, civilian equipment and supplies used by allied forces but excludes medical equipment and supplies.
- e. Pollution (pollute). Destroy the purity of or sanctity of; make foul or filthy; contaminate or defile (man's environment).

DETAILS OF THE AGREEMENT.

4. Priorities. The priorities and the extent of the denial of military equipment and supplies must be decided by the commander ordering it, taking into account the their potential value to the enemy. Some examples could be:

a. As a high priority:

- (1) Classified equipment, materials and documents.
- (2) Petroleum, oil and lubricants.
- (3) Sophisticated weapons systems or electronic equipment.
- (4) Heavy weapons and associated ammunition.
- (5) **Communications equipment.**
- (6) Ferrying and bridging equipment.
- (7) Air, sea and land transport.

b. As a second priority: Any other military stores, military equipments and supplies or military facilities which may be of use to the enemy.

5. Implementation of the Denial. Instructions for the denial of an item of military equipment or of supplies should be included in the appropriate national support publication in sufficient detail to enable their direct use to be denied to an enemy and also to prevent the enemy from making use of them after cannibalization between similar equipments.

* * * * *

3-23. EMERGENCY ALARMS OF HAZARD OR ATTACK

The BC must ensure that emergency alarms of hazard or attack are provided in the unit SOPs. The applicable details to be included in the SOPs have been extracted from STANAG 2047 and are shown below.

* * * * *

EXTRACT
STANAG 2047 (Edition 6)
EMERGENCY ALARMS OF HAZARD OR ATTACK (NBC AND AIR ATTACK ONLY)

* * * * *

Audible and visual alarm signals must be given by means which cannot easily be confused with other sounds or sights encountered in combat. The alarm signals will be given in all cases as soon as an attack or the presence of a hazard is detected. The alarm signals will be repeated throughout the unit area by all who hear or see the original alarm signal since most available alarm signals are generally limited in range. Additionally, audible and visual alarm signals should normally be supplemented by simultaneous use of radio, telephone, and public address systems.

DETAILS OF THE AGREEMENT

3. It is unlikely that personnel can understand and react quickly and correctly to more than two alarm signals. The following hazards require fast and correct reaction: use or presence of chemical or biological agents, and an imminent air attack or nuclear operation. Therefore, alarm signals for these two hazards are mandatory (see Note (1)). In the case of radiological contamination, a delay in personnel taking cover may be acceptable.

Note (1): No reference is made to ground attack in order to reduce to a minimum the number of signals. Signals for ground attack, if deemed necessary, remain the prerogative of field commands.

4. The spoken word (vocal alarm signals) remains the most effective means of informing troops in an emergency.

5. Visual alarm signals are included to supplement the audible alarm signals under conditions when audible signals may be lost due to other noises or to replace audible signals when the tactical situation does not permit the use of sound:

- a. Reliance should not be placed on visual alarm signals during the hours of darkness or in conditions of poor light.
- b. Visual alarm signals should be used when purely audible signals may be lost due to other noise.
- c. Visual signals should be used to warn those personnel arriving at a particular location of an imminent hazard.
- d. Apart from the audio-visual signals detailed at paragraph 2, Note 2 of Annex A, normal signal flares are excluded from use as a color alarm signal for NBC and air attack.
- e. Visual signals need not be used by mobile forces.

6. The actual form of a visual signal and method of display are left to the discretion of the local commander. Only the color at Annex A is mandatory. However, to aid recognition, it is recommended that the red signal preferably be square and the black signal preferably be triangular.

7. The alarm signals listed in this agreement are primarily intended to serve as alarms of enemy action. They may be used, however, in an emergency when friendly action could produce similar effects on its own forces.

8. Conflict with civil regulations. Alarm signals for use by NATO forces operating on land are in Annex A. There are some differences between the alarm signals prescribed herein and some national civil defense alarm signals. These differences are considered minor for air attack. Reservations are indicated by each nation where nations or local regulations prohibit NATO Forces operating in their territory for sounding alarm signals in exercises and/or alarm signals incompatible with the public warning system in wartime.

9. Practice alarm signals. In those case where nations or local regulations preclude sounding alarm signals during exercises, local commanders should negotiate with local authorities to obtain authorization to sound alarm signals periodically. In the absence of agreement, small alarm devices emitting sounds similar to the prescribed audible alarm signals and having limited range should be used during exercises to keep personnel familiar with the audible alarm signals.

IMPLEMENTATION OF THE AGREEMENT

10. This STANAG is implemented when the necessary orders/instructions have been issued, directing forces concerned, to put the content of this agreement into effect.

* * * * *

ANNEX A TO STANAG 2047 (Edition 6)
EMERGENCY ALARMS AND WARNING SIGNALS

* * * * *

The following are emergency alarms and warning signs for NATO Forces operating on land. In respect of the audible alarm signal, one or more of the signals listed below should be used.

| TYPE OF HAZARD | VISUAL WARNING SIGN | AUDIBLE ALARM SIGNAL |
|--------------------------|--------------------------------------|---|
| la. Imminent Air Attack. | 1b. Red. Preferably square in shape. | 1c(1) Unbroken warbling siren for one minute. (2) Succession of long blasts on vehicle horns, whistles, bugles or other wind instruments in a ratio of 3:1; approximately 3 seconds on and 1 second off. (3) Vocal "Air Attack" or corresponding national term where only one nation is involved. TYPE OF HAZARD VISUAL WARNING SIGN AUDIBLE ALARM SIGNAL |

| TYPE OF HAZARD | VISUAL WARNING SIGN | AUDIBLE ALARM SIGNAL |
|---|--|---|
| 2a. Imminent arrival of, or presence of, chemical or biological agents or radiological hazards. | 2b(1) Black. Preferably triangular in shape. (2) Donning respirators and taking protective action followed by such hand signals as may be prescribed in local instructions. (See Notes 1,2, and 3.) | 2c(1) Interrupted warbling sound on a siren. (2) Succession of short signals on vehicle or other horns by beating metal or other objects in a ratio of 1:1; approximately 1 second off. (3) Vocal "Gas, gas, gas" or corresponding national term where only one nation is involved. |
| 3a. All Clear. | 3b. Removal of appropriate warning signal. | 3c(1) Vocal "all clear (s-type of attack)" or corresponding national term when only one nation is involved. (2) If used, a steady siren note for one minute or a sustained blast on a vehicle horn, whistle, bugle or other wind instrument to indicate absence of all NBC and air attack hazards. |

NOTES:

1. Automatic alarms for the early and rapid detection of biological and chemical agents and radiological hazards may complement the devices referred to previously.
2. A special audio-visual pyrotechnic signal producing a whistle sound and a yellow, red, yellow display of lights may be used. The combination of colors should be produced as near simultaneously as possible.
3. Wearing respiratory protection in the presence of radiological hazards is not mandatory but will be decided by the local commander.

* * * * *

3-24. BOMBING, SHELLING, ROCKETING, MORTARING, AND LOCATION REPORTS

The BC must ensure that his unit SOPs provide guidance concerning bombing, shelling, rocketing, mortaring, and location reports including the format to be used when preparing these reports must also be included. Guidance for the commander is provided in FM 6-121, in Appendix J of this manual, and in STANAG 2934, Chapter 13.

* * * * *
EXTRACT FROM STANAG 2934 (Edition 1) Chapter 13, Annex A
FORMAT FOR BOMBING, SHELLING, ROCKETING, MORTARING, AND
LOCATION REPORTS
* * * * *

SECTION I: BOMREP, SHELREP, ROCKREP, MORTREP (indicate which)

- A. UNIT OF ORIGIN. Use current call sign, address group or code name.
- B. POSITION OF OBSERVER. Grid reference preferred - encoded if this discloses the location of a headquarters or important observation post.
- C. DIRECTION (FLASH, SOUND OR GROOVE) AND ANGLE OF FALL/DESCENT (omit for aircraft). Grid bearing of flash, sound or groove of shell (state which) in mils, unless otherwise specified. The angle of fall or descent may be determined by placing a stickhod in the fuze tunnel and measuring in mils, unless otherwise specified, the angle formed by the stick/rod in relation to the horizontal plane.
- D. TIME FROM.
- E. TIME TO.
- F. AREA BOMBED, SHELLED, ROCKETED, OR MORTARED.
 - 1. Location to be sent as:
 - a. Grid reference (clear reference is to be used)
 - OR
 - b. Grid bearing to impact point in mils, unless otherwise specified and distance in meters from observer. This information must be encoded if paragraph B is encoded (when this method is used, maximum accuracy possible is essential).
 - 2. Dimensions of the area bombed, shelled, rocketed, or mortared to be given by:
 - a. The radius (in meters)
 - OR
 - b. The length and width (in meters)
- G. NUMBER AND NATURE OF GUNS, MORTARS, ROCKET LAUNCHERS, AIRCRAFT OR OTHER METHODS OF DELIVERY.
- H. NATURE OF FIRE. Adjustment, fire for effect, harassing, etc. (may be omitted for aircraft).
- I. NUMBER, TYPE AND CALIBER (state whether measured or assumed) OF SHELLS, ROCKETS (OR MISSILES), BOMBS, ETC.
- J. TIME OF FLASH TO BANG (omit for aircraft).
- K. DAMAGE (encode if required).
- L. REMARKS. (for additional information on Sections I, II, or III).

SECTION II: LOCATION REPORT

- M. SERIAL NUMBER. Each location which is produced by a locating unit is given a serial number.
- N. TARGET NUMBER. If the weapon/activity has previously been given a target number, it will be entered in this column by the locating units.

P. POSITION OF TARGET. The grid reference or grid bearing and distance of the located weapon/activity.

Q. ACCURACY. The accuracy to which the weapon/activity has been located. CEP in meters and the means of location if possible.

A: CEP is 50 meters or better.

B: CEP between 50 meters and 100 meters.

C: CEP between 100 and 150 meters.

D: CEP between 150 and 200 meters.

E: CEP between 200 meters and 300 meters, and

I: CEP worse than 300 meters.

R. TIME OF LOCATION. The actual time the location was made.

S. TARGET DESCRIPTION. Including dimensions if possible:

1. Radius of target in meters

OR

2. Target length and width in meters (attitude if possible).

SECTION III: COUNTERFIRE ACTION

T. TIME FIRED. Against enemy target.

U. FIRED BY.

V. NUMBER OF ROUNDS-TYPE OF FUZE AND PROJECTILES.

* * * * *

CHAPTER 4

LAYING THE BATTERY, MEASURING, AND REPORTING

Section I

THE AIMING CIRCLE

4-1. DESCRIPTION OF THE AIMING CIRCLE

The M2A2 aiming circle is the primary means of orienting the cannon battery or laying weapons on the azimuth of fire. This section presents information that should be the starting point for any training program on the aiming circle. The aiming circle components are discussed below.

a. Telescope. The telescope is a four-power, fixed focus optical instrument with a reticle pattern like the one shown in Figure 4-1.

Note: Some aiming circles may not be equipped with the P-2 reticle pattern (national stock number [NSN] 1240-01-1 52-8516) which is used to perform the POIARIS 2 method of hasty survey. modification can be made at direct support maintenance. Verify the expiration date in the lower right hand corner of the P-2 reticle pattern. If it has expired, turn in the aiming circle to direct support (DS) maintenance for repair.

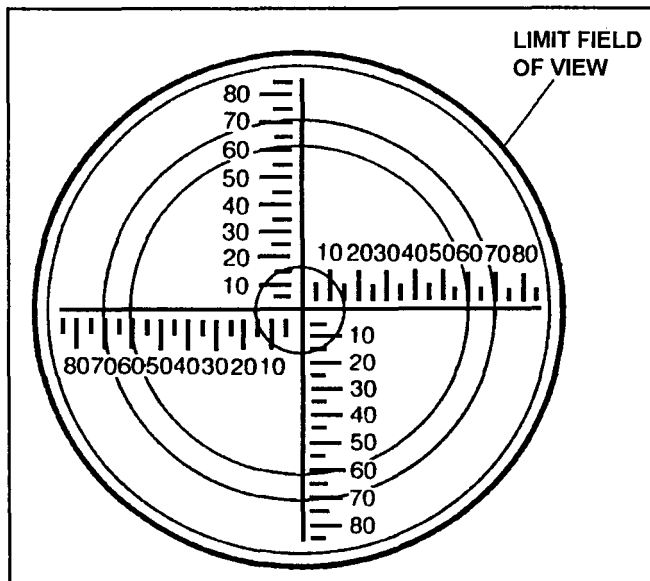

Figure 4-1. Polaris 2 reticle pattern

b. Reflector. The reflector (Figure 4-2, page 4-2) is a plastic signal post mounted on top of the telescope. It is used as an aiming point for other instruments sighting on the aiming circle.

c. Elevation Knob. The elevation knob (Figure 4-3, page 4-2) is used to raise and lower the telescope line of sight. It is also used to measure vertical angles. (See paragraph 4-26.)

(1) Elevation scale. Each graduation on the elevation scale (Figure 4-3) represents 100 mils. The scale is numbered at 100-mil intervals. The black numbers 0 to 1100 indicate elevation (+). The red numbers 0 to 400 indicate depression (-).

(2) Elevation micrometer scale. Each graduation on the elevation micrometer scale (Figure 4-3) represents 1 mil. The scale is numbered at 10-mil intervals. The black numbers 0 to 100 indicate elevation (+). The red numbers 0 to 100 indicate depression (-).

d. Magnetic Compass. The magnetic compass is located in the main housing (Figure 4-3). For rough centering, the magnetic needle may be seen through the windows on top of the body assembly. A small glass magnifier (Figure 4-3) and reticle with three vertical lines are at one end of the recess. These aid in aligning the end of the magnetic needle.

e. Leveling Vials. There are two tubular leveling vials and one circular leveling vial (Figure 4-2) on the aiming circle. One tubular leveling vial (on the left side of the elbow telescope) is used in leveling the telescope so that the operator can measure vertical angles. The other tubular leveling vial (located on the left side of the main housing) or the circular leveling vial (fisheye bubble) is used in leveling the aiming circle for measuring horizontal angles. When the tubular leveling vials are not in use, the protective covers should be closed to prevent damage.

f. Azimuth and Azimuth Micrometer Scales.

(1) The azimuth scale (Figure 4-3) is located below the magnetic compass housing. It is graduated in 100-mil increments from 0 to 6,400 mils and is numbered every 200 mils. The portion of the azimuth scale from 3,200 mils through 6,400 mils has a second 0-3200 scale numbered in red from the black 32 through the large black 0 on the azimuth scale.

Note: Also located on the azimuth scale is an imaginary line called the 0-3200 line. This line starts at the black 0 and goes through the black 32 on this scale. This is the line we orient on the azimuth of fire during the laying process.

(2) On the azimuth scale, the red numbers 0 to 3200 indicate azimuth. The lower row of graduations parallels the 3,200- to 6,400-mil upper row of graduations. This permits the aiming circle to be used with other instruments that have scales labeled from 0 to 3,200 mils. The red numbers are used only in the following instances:

(a) You are reading red numbers to an M12-series sight, and you are measuring a deflection.

(b) You are checking the lay of one aiming circle with a second circle. The operator of only one of the two circles will see red. He can read red to preclude having to add or subtract 3200 to or from the reading.

(3) The azimuth micrometer (Figure 4-3) is located on the azimuth knob on the lower right side of the magnetic needle housing. It is graduated in 1-mil increments from 0 to 100 mils and is numbered every 10 mils. Azimuth micrometer can be read to an accuracy of 0.5 mils.

g. Upper (Recording) Motion. The upper motion allows the operator to place values on the azimuth scale and azimuth micrometer by means of the azimuth knob (Figure 4-3). The values are read on the azimuth scale index, which is located below the magnetic needle magnifier. The upper motion of the instrument has both a fast motion and a slow motion. Pulling back on the azimuth knob enables fast motion. Rotation of the azimuth knob produces slow motion. Horizontal angles are read in two parts--the thousands and hundreds of mils are read from the azimuth scale, and the tens and units of mils are read from the azimuth micrometer.

h. Lower (Nonrecording) Motion. The lower motion is controlled by the orienting knobs (Figure 4-2). It is used to orient the 0-3200 line of the aiming circle without changing the values on the upper motion. Lateral movement of one orienting knob enables fast movement of the lower motion of the aiming circle. The two orienting knobs should be used at the same time for slow movement of the lower motion. Caps are provided for covering the orienting knobs to prevent unintentional use of the lower motion.

i. Leveling Screws. The three leveling screws (Figures 4-2 and 4-3) are used to level the aiming circle. These screws are on a spring plate located below the orienting knobs and above the baseplate assembly.

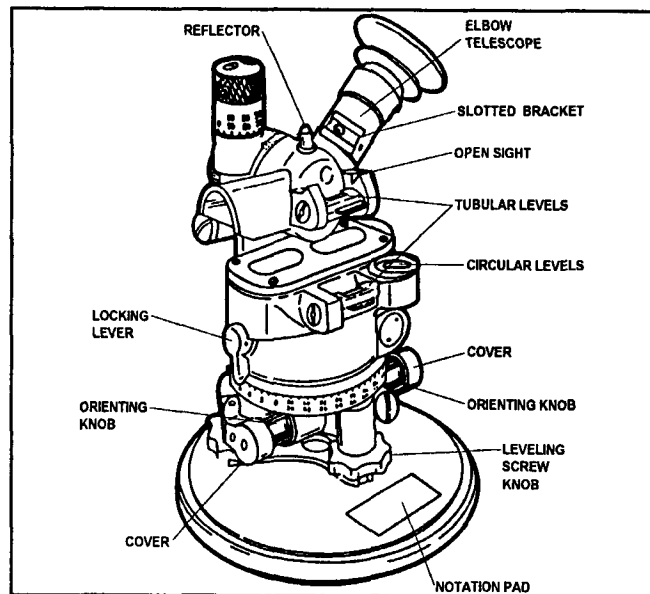

Figure 4-2. Aiming circle (left side view)

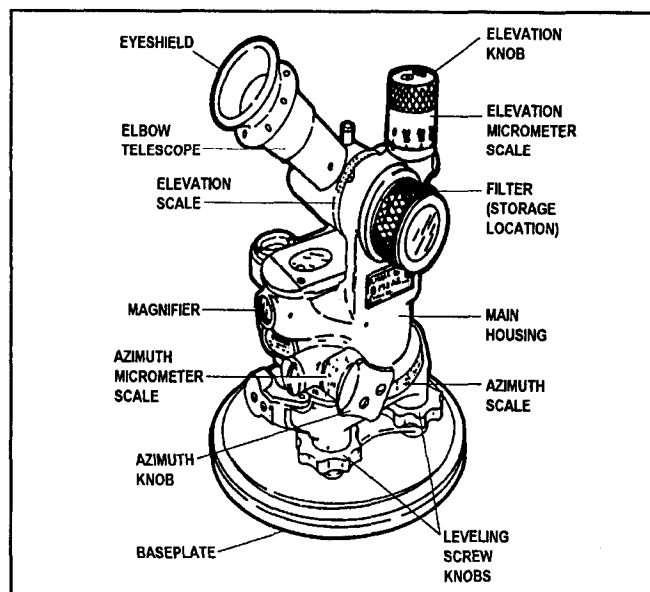

Figure 4-3. Aiming circle (right side view)

j. Base Plate Assembly. The base plate assembly (Figure 4-3) serves as the base of the instrument when it is mounted on the tripod and also serves as the base of the carrying case. It is a flat circular plate to which the instrument is attached by means of the spring plate. An instrument-fixing screw is threaded into a socket on the underside of the base plate assembly to attach the instrument to the tripod. The socket is kept clean and free of obstructions by a spring-loaded cover that remains closed when the instrument is not attached to the tripod. The base plate is fitted with a rubber gasket

that forms a watertight seal when the cover is latched to the baseplate.

k. Notation Pad. A rectangular notation pad (Figure 4-2) on the baseplate is used for recording the declination constant, date of declination, and initials of the person performing the declination.

l. Filter. The filter (Figure 4-3) is a lens, which is placed over the eyepiece for protection against the sun's rays. It is stored on the side of the telescope body. It is held in place by a spring-loaded ball.

m. Compass Needle Locking Lever. When the locking lever (Figure 4-2) is in a vertical position, the needle is locked. When the lever is turned either right or left to the horizontal position, the needle is unlocked. To preclude damage to the magnetic needle, this lever should be returned to the locked position gently.

CAUTION
The needle must be locked when not in use.

4-2. SETTING UP THE AIMING CIRCLE

a. To setup the aiming circle (Figure 4-4), do the following actions:

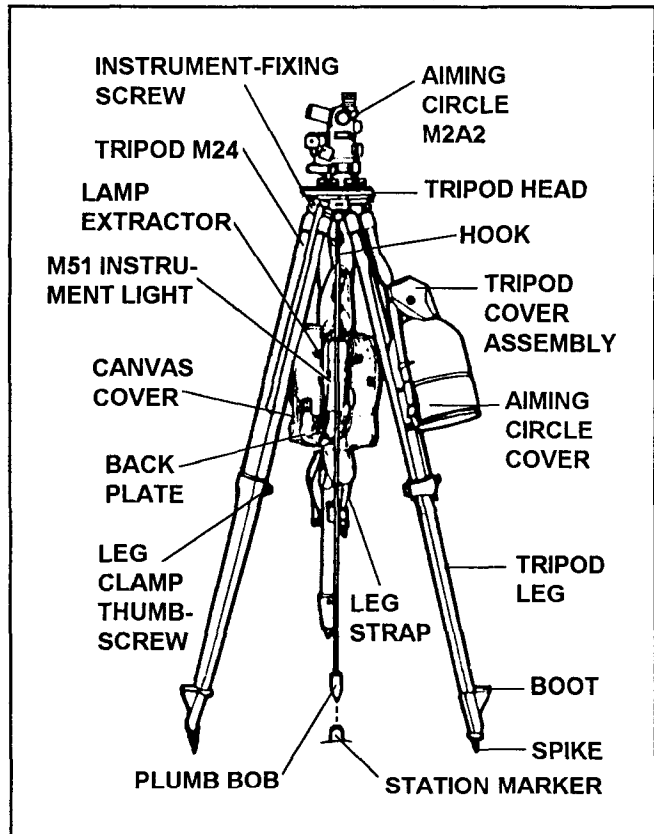

Figure 4-4. Aiming circle with tripod

(1) Unstrap the legs of the tripod, loosen the leg clamp thumbscrews, and extend the legs to the desired length. Tighten the leg clamp thumbscrews.

(2) Place the tripod over the point to be occupied. One tripod leg should be pointing in the approximate direction of sighting, and the leg with the night-light mount should be to the operator's left. Attach the plumb bob to the hook under the instrument-fixing screw assembly. The plumb bob should be within a 1-inch radius of the station marker.

(3) Firmly embed the tripod legs. Make sure the tripod head is approximately level when the legs are embedded. Then remove the tripod head cover.

(4) Pull back the spring-loaded cover on the base of the baseplate and place the aiming circle on the tripod. Loosely screw the instrument-fixing screw assembly into the base plate.

(5) Center the plumb bob over the orienting station by moving the base plate of the aiming circle.

(6) Tighten the instrument-fixing screw into the baseplate of the aiming circle.

CAUTION
Be careful not to exert excessive pressure when you are tightening the instrument-fixing screw. The slotted arm may bend and damage the tripod head.

(7) Remove the aiming circle head cover, and hang it on the tripod head cover or a leg clamp thumbscrew to prevent damage.

(8) Install the night lighting device accessory case if necessary.

b. Some common malpractice are as follows:

- Not clearing the area of magnetic attractions such as weapons, steel helmets, and eyeglasses.
- Failure to set up the tripod so that one leg points in the direction of the sighting. This puts one more tripod leg in the instrument operator's way as he moves around and increases the chance that he will kick a leg and knock the aiming circle off level.

4-3. LEVELING THE AIMING CIRCLE

There are two methods of leveling the aiming circle for normal use. Either the circular leveling vial or the tubular leveling vial (Figure 4-5) can be used.

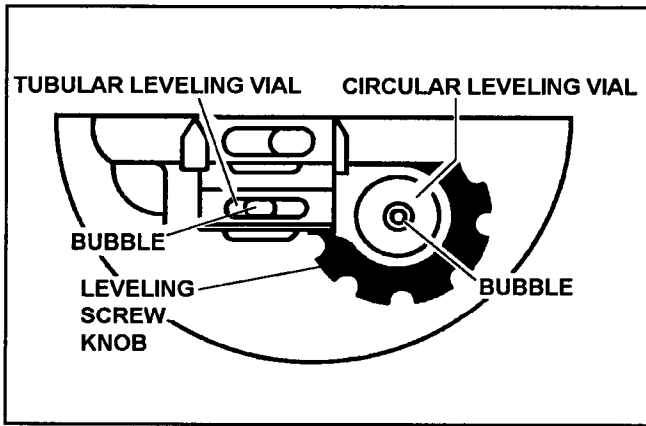

Figure 4-5. Leveling vials

a. The preferred method is to level the aiming circle by using the circular leveling vial (fisheye bubble) as follows:

- (1) Loosen the leveling screws approximately halfway.
- (2) Rotate the head of the aiming circle until the circular leveling vial is over the leveling screw adjacent to the notation pad.
- (3) Using the thumb and forefinger of each hand, turn the other two leveling screws in opposite directions. The bubble will move in the same direction as the left thumb.

Note: This is known as the left thumb rule.

(4) When the bubble moves on line with the fisheye, center the bubble by using only the third leveling screw. Rotate the head over each of the other two screws. If more than half the bubble moves out of the center ring, relevel the instrument. If the bubble cannot be centered, use the technique discussed in b below. Then turn the instrument in for repair as soon as possible.

b. Level the aiming circle by using the tubular leveling vial as follows:

(1) Loosen the three leveling screws (approximately halfway) to permit the instrument to be leveled. Rotate the instrument until the axis of the tubular leveling vial is parallel to any two of the three leveling screws. Center the bubble by using these two leveling screws. Grasp a screw between the thumb and forefinger of each hand. Turn the screws simultaneously so that your thumbs move either toward each other or away from each other. This movement tightens one screw as it loosens the other. The bubble always moves in the same direction as the left thumb.

(2) Rotate the instrument 1,600 mils, and center the bubble by turning the third leveling screw.

(3) Rotate the instrument back to the first position, and relevel the bubble if necessary.

(4) Repeat these steps until the bubble remains centered in both positions.

(5) Rotate the instrument 3,200 mils from the first position. If the bubble remains centered in this position, rotate the instrument 3,200 mils from the second position. If the bubble remains centered in this position, rotate the instrument throughout 6,400 mils. If the bubble does not remain centered when the instrument is rotated 3,200 mils from the first position, the leveling vial is out of adjustment. To compensate, using the same leveling screws that were used to place the instrument in the first position, move the bubble halfway back to the center of the leveling vial. Rotate the instrument 3,200 mils from the second position; and using the other leveling screw, move the bubble halfway back to the center of the level vial. The instrument is now level, and the bubble should come to rest in its vial at the same off-center position (within one graduation) regardless of the direction in which the instrument is pointed. If the leveling vial is out of adjustment, the instrument should be turned in for repair at the first opportunity.

(6) The plumb bob normally remains attached to the aiming circle until the firing unit is laid.

4-4. TAKING DOWN THE AIMING CIRCLE

Take down the aiming circle as follows:

- a. Elevate the telescope to about 300 mils.
- b. Ensure that the magnetic needle is locked.
- c. Cover the tubular leveling vials. Be sure the M51 instrument light is turned off and secured in its case.
- d. Ensure the caps of the orienting knobs are closed.
- e. Place the azimuth knob over the notation pad.
- f. Turn the leveling screws counterclockwise until the screws are to their lower stops. Then loosen each leveling screw knob one-quarter turn.
- g. Place the carrying case cover over the aiming circle, and latch the cover locks.
- h. Unscrew the instrument-fixing screw, and remove the instrument from the tripod.
- i. Replace the tripod head cover.
- j. Retract and collapse the tripod legs, and tighten the thumbscrews.
- k. Strap the tripod legs together.

4-5. DECLINATING THE AIMING CIRCLE

a. The aiming circle must be declinated when any of the following situations exist:

- After an electrical storm.
- Anytime the instrument has received a severe shock; for example, if it is dropped from the bed of a truck to the ground. The magnetic needle is a delicately balanced mechanism, and any shock may cause a significant change in the declination constant.
- Anytime the aiming circle is moved outside a 25-mile radius from the area in which it was last declinated. Because of local magnetic attractions, any move of the aiming circle may result in an appreciable change in the relationship of grid north and magnetic north as measured by the instrument.
- A minimum of once every 30 days to determine if any changes in the declination have occurred because of the annual shift of magnetic north or because of accidents involving the instrument that may not have been reported. If a radical change is observed, the instrument should be declinated again within a few days to determine if the observed change is a real change in the characteristics of the instrument.
- When the instrument is first received.
- Anytime the instrument is returned from ordnance repair.

b. The aiming circle must be declinated in an area free from magnetic attractions. Azimuths must be known to two or more azimuth marks, preferably in opposite directions. These azimuth marks should be a minimum distance of 300 meters, preferably 1,000 meters.

c. Declinate the aiming circle as follows:

- (1) Set up the aiming circle, and level it.
- (2) With the upper (recording) motion, set the known azimuth to the azimuth marker.
- (3) With the lower nonrecording motion, sight on the azimuth marker that corresponds to the azimuth set with the upper motion. (See Figure 4-6.)

Note: At this time, the 0-3200 line will be aligned with grid north.

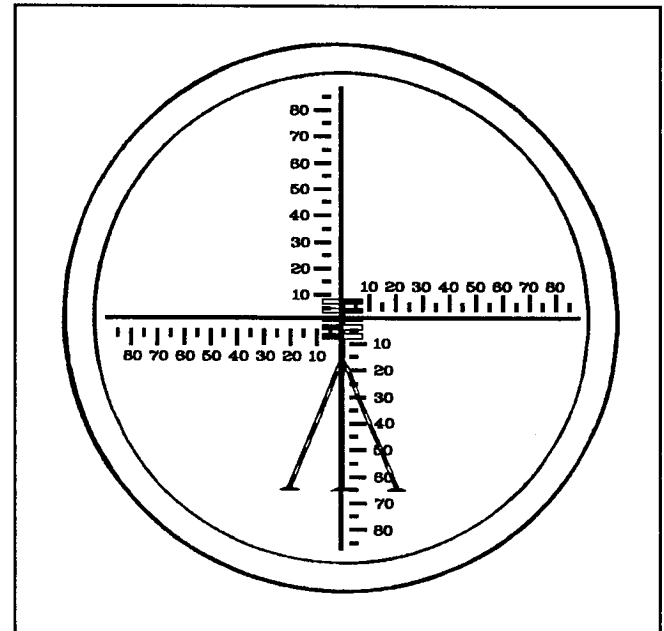

Figure 4-6. Proper sight picture

(4) Release the magnetic needle. With the upper motion, float and center the magnetic needle. (See Figure 4-7, page 4-6.)

(5) Read the declination constant directly from the azimuth scales (to the nearest 0.5 mil).

(6) Using a second azimuth, repeat the above steps. (If a second azimuth marker is not available, use the first marker again.)

(7) Compare the two declination constants determined. If they agree within 2 mils, determine the mean. Express it to the nearest whole mil by using artillery expression. On the notation pad, record the mean (four-digit number), the date, and the initials of the individual performing the declination.

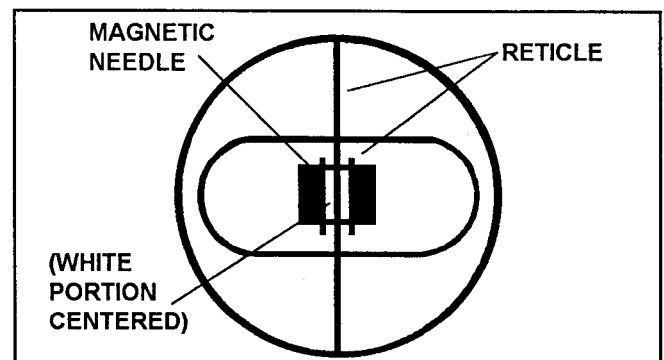

Figure 4-7. Centering the magnetic needle

Note: If the two values differ by more than 2 mils, repeat the entire process.

d. A declination station may be established by simultaneous observation, hasty astro, observation of Polaris, or circumpolar observation. (See Chapter 5.)

e. Declination can be performed by scaling a grid azimuth to two distant points. The following procedures are used:

(1) Place the aiming circle over the selected point and level it.

(2) Select two distant points on a map. Scale the direction to each from the occupied point.

(3) Using the direction scaled from the map, declinate the aiming circle by the procedures previously discussed.

(4) Compare the two values determined. They must agree within 10 mils.

(5) If the values determined agree within 10 mils, determine the mean; record it on the notation pad. If the values do not agree within 10 mils, repeat the entire procedure.

Note: A declination constant determined by simultaneous observation or from a map should be verified as soon as possible.

4-6. CARE AND HANDLING OF THE AIMING CIRCLE

- a. Protect the aiming circle from shock.
- b. Keep the instrument clean and dry.
- c. Clean the lens with an optical lens cleaning brush and lens tissue only.
- d. Keep the magnetic needle locked anytime it is not in use.
- e. Keep the aiming circle head cover over the aiming circle head.
- f. Cover all tubular leveling vials.
- g. Rotate the azimuth knob until it is over the notation pad before trying to replace the head cover.

Section II

PRECISION LIGHTWEIGHT GPS RECEIVER (PLGR)

4-7. GLOBAL POSITIONING SYSTEM DESCRIPTION

Global positioning system (GPS) is a space-based navigation system which provides worldwide, continuous, all weather, three-dimensional position information. The GPS system consists of the following three primary components:

- The satellite constellation. Ensures worldwide coverage with a minimum of four satellites within electronic line of sight to any point on the earth.
- A master control station and five monitoring stations. These provide ground-based support for the satellites.
- The GPS receivers. These receivers provide the operator with navigational and location data.

Currently, the primary receiver being issued to ground forces is the AN/PSN-11, precision lightweight GPS receiver (PLGR). The PLGR can provide location information precise enough for use by cannon artillery. For detailed

information on the GPS/PLGR operation, maintenance, and additional equipment, refer to TM 11-5825-291-13. Major components of the PLGR are shown in Figure 4-8.

4-8. FA SURVEY APPLICATIONS

The PLGR can be used to determine the grid location of the orienting station. Individual howitzer locations can also be determined, but individual PLGR-derived positions are not on common survey control. The following actions must be taken to ensure accuracy when using the PLGR as an artillery positioning device:

a. Verify PLGR Setup.

- (1) **Crypto.** The proper crypto keys must be loaded before the PLGR will function using the precise positioning system (PPS). The PPS must be used to achieve the necessary accuracy and to avoid enemy electronic warfare measures. **If the crypto variable is not loaded, the PLGR cannot be used to establish artillery positions.**

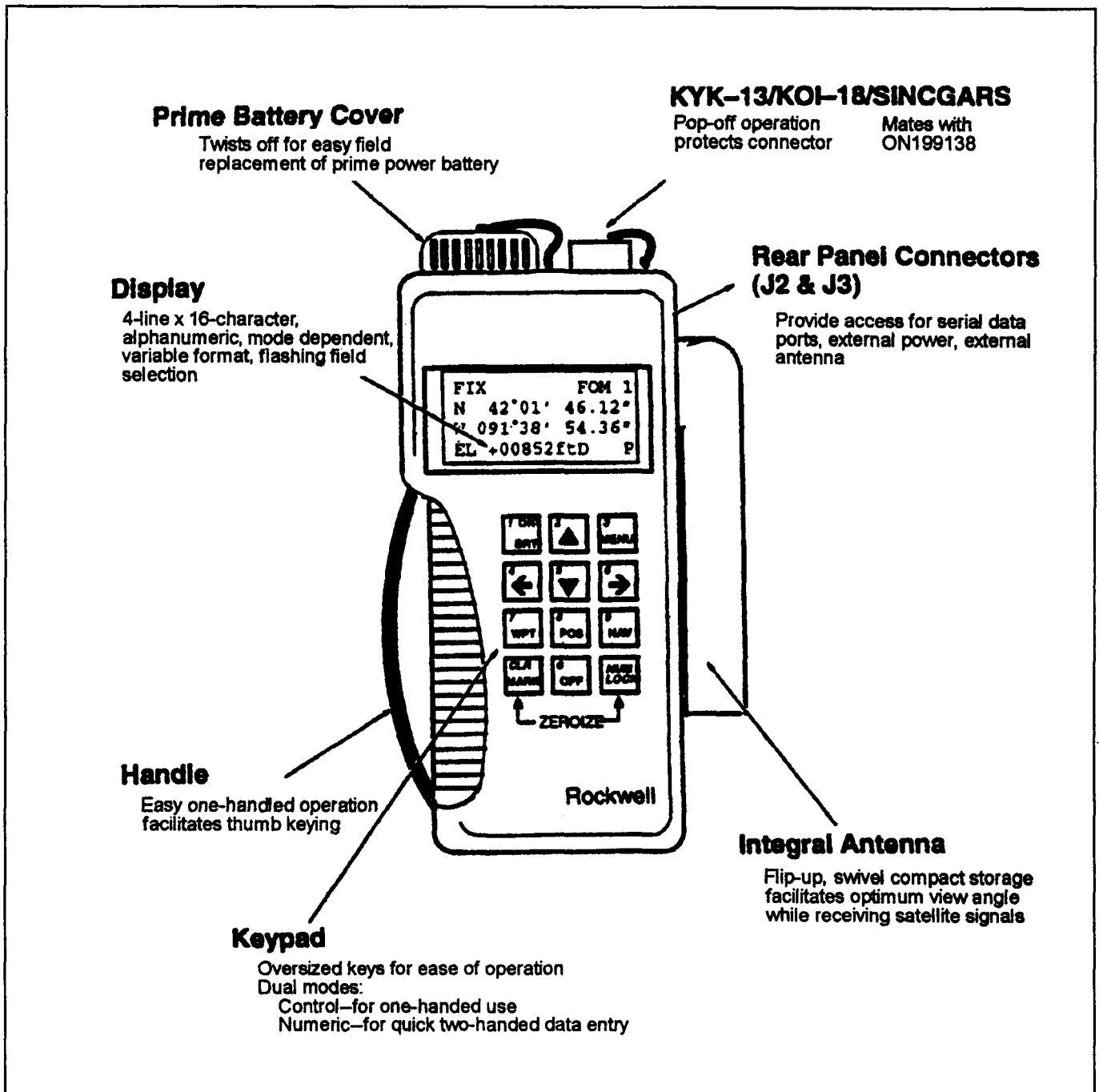

Figure 4-8. Precision lightweight GPS receiver (PLGR)

(2) Datum. Map datum should be the same as the operational datum being used by all other maneuver, fire support and target acquisition units. If the same datum is not used, significant position errors are possible.

(3) Coordinates. The UTM coordinate format is preferred since it is the standard used by survey and most fire control systems.

(4) Elevation. Mean sea level is the preferred selection since most military maps use it as the basis for the elevation scale.

(5) Units of measurement. Meters is the preferred selection since most military maps refer to distance and elevation in meters.

(6) Almanac data. Almanac data must be 1 day old. If almanac data are not 1 day old, there are possible satellite vehicle or timing errors not noted by the PLGR.

b. Figure of Merit (FOM). FOM is an accuracy estimation of the data displayed by the PLGR which ranges from one through nine. FOM 1 is the best accuracy estimation displayed by the system, and FOM 9 is the worst. For artillery positioning, only coordinates determined with a FOM 1 will be considered for use.

c. Mode of Operation. The PLGR offers the choices of **FIX**, **CONTINUOUS**, or **AVERAGING** as modes of operation. The **AVERAGING** mode yields the most accurate data and is preferred when determining a position for indirect fire weapons.

d. Verify Position. Position verification, to check for unacceptable errors, must always be done prior to firing. The following are possible methods of verifying a PLGR-derived grid coordinate:

- (1) Always use two persons to check the PLGR data.
- (2) Use two different PLGRs to independently determine the position data.
- (3) Use resection or graphic resection if identifiable points are visible.
- (4) Conduct a map spot of the location. A map spot is the minimum acceptable verification and should be used in conjunction with the other available means.

WARNING

Azimuth determined with the PLGR is for navigation only. The PLGR azimuth is not accurate enough for use in establishing directional control and should never be used for that purpose. Tests show that the PLGR-determined azimuth may be in error by as much as 200 mils.

4-9. GPS LIMITATIONS AND CONSIDERATIONS

a. GPS receivers rely on electronic line of sight with the satellites. The PLGR must be able to acquire at least four satellites before a three dimensional position can be determined. Dense foliage, buildings, mountains, and canyons will mask GPS signal and cause the receiver to fail. All GPS receivers automatically try to track satellites to a position as low as 10° above the level horizon. Each receiver has a function which displays the direction and vertical angle to each of the satellites being tracked. Use this display to determine if signal masking is what is causing the system to fail. When a satellite signal is masked, the operator can either reorient the PLGR antenna or move to another location to improve signal reception.

b. Multipath distortion (reflected signals) may occur if the receivers antenna is tilted away from a satellite. This causes a reflected signal to be received which has more power than the direct signal. Coordinates determined under these conditions can be off by as much as several hundred meters. To correct this problem, reorient the receiver antenna to a position that eliminates the distortion.

c. As with all aspects of artillery operations, personnel must be properly trained in the safe operation of equipment. The PLGR will provide accurate location data only if it is operated in strict accordance with the procedures outlined in the technical manual. Battalions and batteries must ensure that training and testing on GPS operations are part of their safety certification program. Specifically, all battery level leadership must be able to identify, and properly correct when needed, the setup functions of the PLGR. These personnel must also be proficient in map reading and hasty survey techniques needed to conduct an independent verification check of the PLGR-derived position.

SECTION III

GUN LAYING AND POSITIONING SYSTEM

4-10. DESCRIPTION OF THE GUN LAYING AND POSITIONING SYSTEM

The gun laying and positioning system (GLPS) supplements the M2A2 aiming circle, and will be the primary instrument used to orient howitzers in cannon units not equipped with Paladins. When used in conjunction with the PLGR, the GLPS will determine grid location, establish directional

control, and allow the operator to transfer directional control to the individual howitzers using standard laying commands. Additionally, the GLPS eye-safe laser range finder eliminates the need to measure subtense to determine the distance to the howitzer.

The system is man-portable and tripod-mounted. It can be emplaced and used much the same as the M2A2 aiming

circle, but without the need for external survey support. Technical data on GLPS capabilities are located in Table 4-1, and the major components of the system are shown in Figure 4-9. Battery leadership must be proficient in the setup and orientation procedures for the GLPS as listed in the equipment operator's manual. An independent check of the GLPS orientation must be made before using it to lay the howitzers.

Table 4-1. GLPS technical data

| | |
|--------------------------------|---|
| Gyroscope | |
| Accuracy of orientation | 0.4 mil PE |
| Theodolite | |
| Telescope mag | 10X |
| Graduation | 0.1 mil |
| Resolution of Hz and V circles | 0.1 mil |
| Laser Range Finder | |
| Accuracy | ±1 m |
| Range | 30 m to 2,000 m |
| Eye safe | |
| Interfaces | |
| PLGR | RS232C |
| GPS Accuracy | |
| Positioning accuracy | 10 meters CEP (horiz) 10 meters PE (alt) |

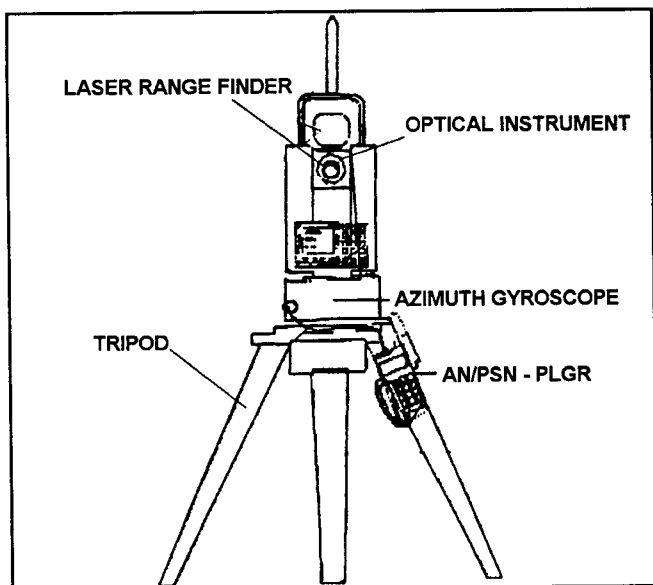

Figure 4-9. Components of the GLPS

Section IV
THE M2 COMPASS

4-11. DESCRIPTION OF THE M2 COMPASS

The M2 compass (Figure 4-10) is the alternate instrument for orienting, or laying cannons. The unmounted magnetic compass is a multipurpose instrument used to obtain angle of site and azimuth readings. The components of the M2 compass are discussed below.

a. Azimuth Scale. The azimuth scale is numbered every 200 mils from 0 to 6400. The scale is graduated every 20 mils and can be read to an accuracy of 10 mils.

b. Sights. The compass has front and rear leaf sights and a mirror in the cover for sighting and reading angles.

c. Levels. The compass is equipped with a circular level for leveling the instrument before the azimuth values are read. A tubular level is used with the elevation scale to measure angles of site.

d. Angle-of-Site Mechanism. Rotation of the level lever causes the elevation level and the elevation scale index to rotate as a unit. The index clamps against the bottom piece to keep the mechanism from moving unless it is actuated by the level lever.

e. Magnetic Needle and Lifting Mechanism. The magnetic needle (the white end of the needle) shows a magnetic north direction for orienting purposes. The needle is delicately balanced and jewel-mounted, on a pivot, to rotate freely. The magnetic needle reading is taken when the bubble is centered in the circular level. The lifting

mechanism includes a needle-lifting (locking) pin and a needle lifting lever. The lower end of the pin engages the lever. The upper end projects slightly above the body of the compass to engage the cover when it is closed. Thus, it automatically lifts the needle from its pivot and holds it firmly against the glass window.

f. Azimuth Scale Adjuster Assembly. The azimuth scale adjuster assembly rotates the azimuth scale to introduce the declination constant. Two teeth at the adjuster engage teeth on the underside of the azimuth scale. Thus, turning the adjuster with a screwdriver rotates the azimuth scale approximately 1,800 mils. The scale is read against a fixed index under the rear sight hinge.

4-12. DECLINATING THE M2 COMPASS

a. The procedure for declinating the M2 compass from a surveyed declination station free from magnetic attractions is as follows:

- (1) Set the M2 compass on an aiming circle tripod over the orienting station, and center the circular level.
- (2) Sight in on the known, surveyed azimuth marker.
- (3) Using the azimuth adjuster scale, rotate the azimuth scale until it indicates the same as the known surveyed azimuth.
- (4) Recheck sight picture and azimuth to the known point. Once the sight picture is correct, and the azimuth reading is the same as the surveyed data, the M2 is declinated.

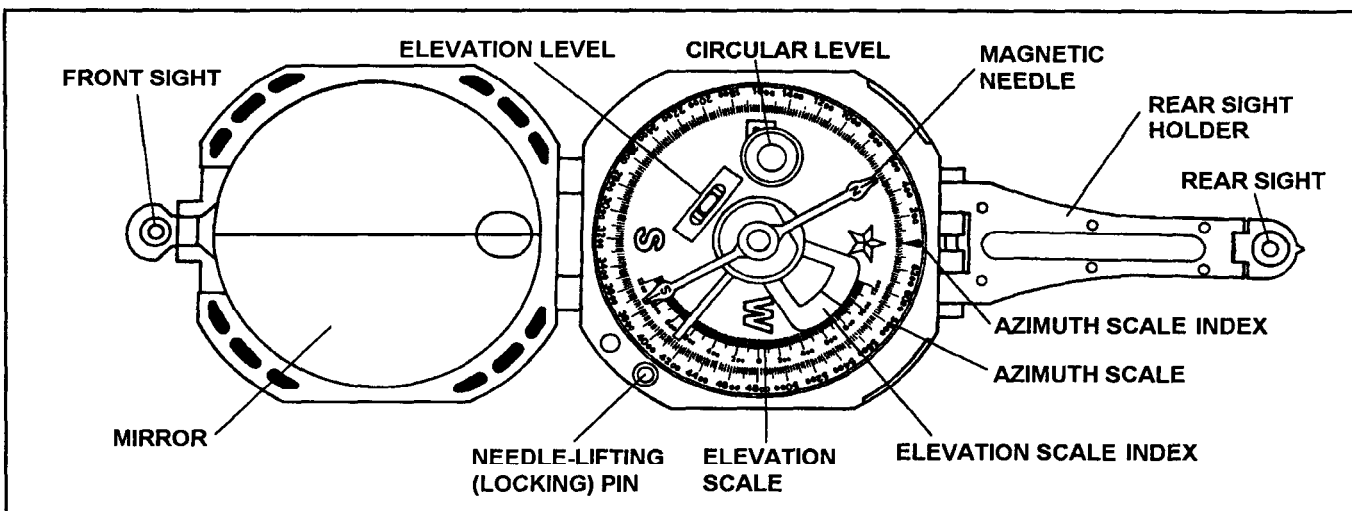

Figure 4-10. M2 compass, top view

b. The procedure for field-expedient declination of the M2 compass is as follows:

(1) Using the azimuth adjuster scale, set off the grid-magnetic (G-M) angle (shown on the bottom of all military maps).

(2) Once the G-M angle has been set off on the azimuth scale, the M2 compass is declinated.

4-13. MEASURING AN AZIMUTH AND SITE TO CREST WITH THE M2 COMPASS

a. The procedure to measure an azimuth follows:

To read the azimuth scale by reflection, hold the compass in both hands at eye level with arms braced against body and with the rear sight nearest your eyes. Place the cover at an angle of approximately 45° to the face of the compass (Figure 4-11) so that the scale reflection can be viewed in the mirror. Level the instrument by viewing the circular level in the mirror. Sight on the desired object and read the azimuth indicated on the reflected azimuth scale by the south-seeking (black) end of the compass needle.

b. The procedure to measure site to crest follows:

Hold the compass on edge with both hands at eye level with arms braced against the body and with the rear sight nearest your eyes. Place the cover at approximately 45° to the face of the compass (Figure 4-11) so that the elevation scale reflection can be seen in the mirror. Sight on the crest of the highest object in the sector of fire. Center the elevation scale tubular level with the lever on the back of the compass and by viewing the elevation scale in the mirror. Read the elevation in mils on the elevation scale. Measure the sight to crest two additional times, and record the average.

CAUTION

When measuring an azimuth be sure no magnetic materials are near the compass.

4-14. CARE AND HANDLING OF THE M2 COMPASS

The M2 compass will not stand rough handling or abuse. Keep the compass in the carrying case (with the mirror side facing in) protected from dust and moisture.

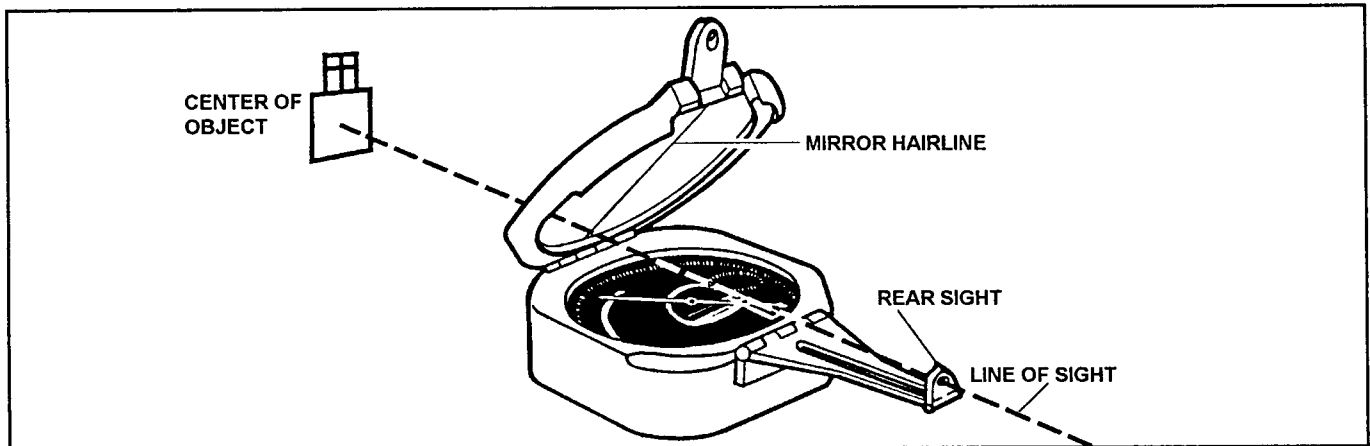

Figure 4-11. M2 compass, observer's view

Section V LAYING

4-15. PRINCIPLES OF LAYING

a. Reciprocal laying is a procedure by which the 0-3200 line of one instrument and the 0-3200 line of another instrument are laid parallel. To fully understand the principle behind reciprocal laying (Figure 4-12, page 4-12) you must first understand several concepts and definitions.

(1) As was mentioned previously, the aiming circle is the primary means by which the cannon battery orients weapons on the azimuth of fire. The aiming circle is used to measure horizontal clockwise angles from the line of fire to the line of sight to a given aiming point. In reciprocal laying, the aiming point for the aiming circle is the howitzer panoramic telescope. The pantel is used to measure

horizontal clockwise angles from the line of fire or the rearward extension of the line of fire to the line of sight to a given aiming point. In reciprocal laying, the aiming point for the howitzer panel is the aiming circle.

(2) The line of fire, as it relates to the principle of reciprocal laying, is any line parallel to the azimuth of fire. It is first established by the aiming circle in order that the aiming circle can be used to orient the howitzer on the azimuth of fire.

(3) The rearward extension of the line of fire is the exact opposite of the line of fire.

(4) A deflection is defined as a horizontal clockwise angle measured from the line of fire or the rearward extension line of fire to the line of sight of a given aiming point with the vertex of the angle at the panel. That is to say, the angular measurements taken when reciprocally laying with the aiming circle and the howitzer panel will always be deflections.

b. The principle of reciprocal laying is based on the following geometric theorem: given two lines cut by a common transversal whose alternate interior angles are equal, then those two lines are said to be parallel. The parallel lines are the 0-3200 lines of the aiming circle and the line of fire and rearward extension of the line of fire of the howitzer. The common transversal is the line of sight established between the aiming circle and the panel. The

alternate interior angles are the deflections as read from the instruments.

4-16. PROCEDURES FOR LAYING

a. When the 0-3200 line of the aiming circle is parallel to the azimuth of fire, the instrument operator uses the upper motion to sight on the lens of the panel and reads the deflection on the azimuth and azimuth micrometer scales. He announces the deflection to the gunner on the howitzer.

Note: If the weapons are equipped with M12-series deflection cannot exceed 3,200 mils. Therefore the red numbers on the aiming circle are used if the black numbers exceed 3,200 mils.

b. The gunner sets the announced deflection on the panel. He orders the howitzer to be shifted, and/or traverses the tube, until the line of sight through the panel is again on the reflector of the aiming circle (2-step deflection method).

Note: Because the panel is not directly over the pivot point of the tube, the panel displaces horizontally. When the telescope has been sighted on the aiming circle, the gunner reports **READY FOR RECHECK**.

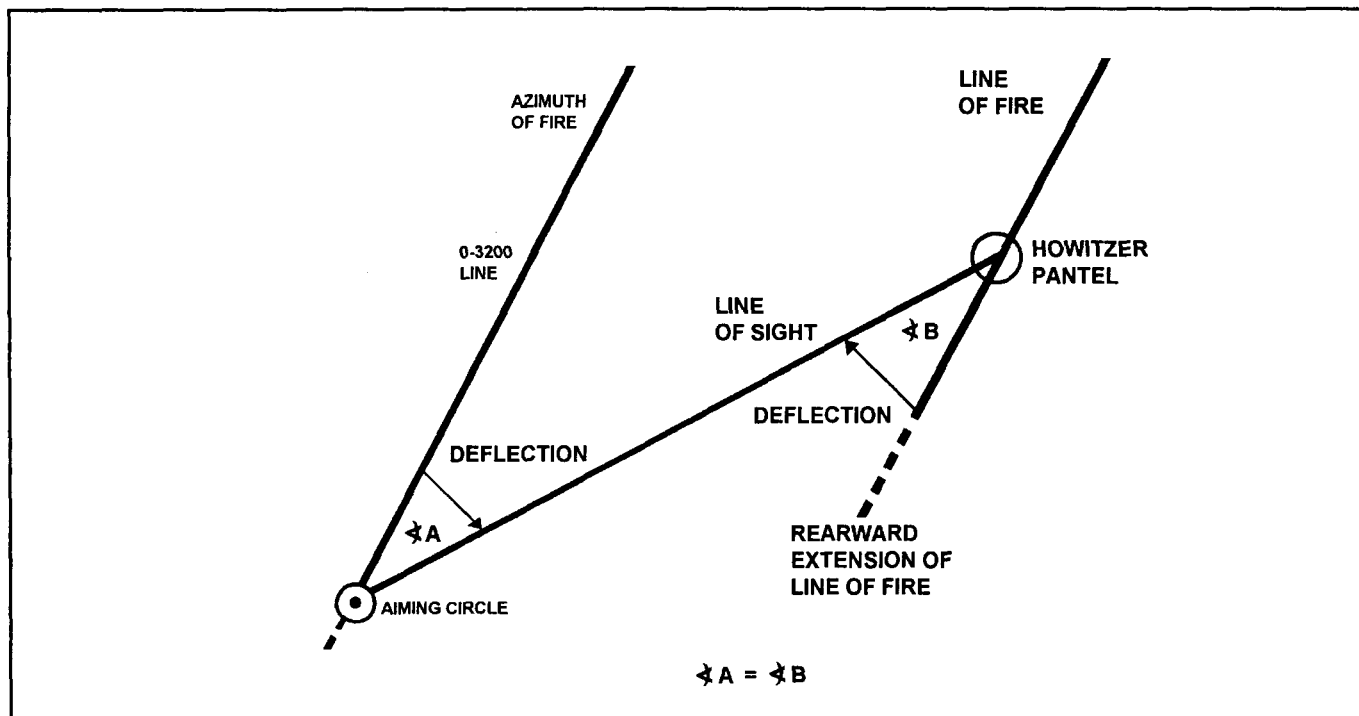

Figure 4-12. Principles of reciprocal laying

c. The instrument operator again sights on the lens of the pantel and reads and announces the deflection. This procedure is repeated until the gunner reports a difference of 0 mils between successive deflections. The piece has then been laid.

d. If all pieces are not able to see the aiming circle, one piece can lay others (reciprocal laying). The commands for laying reciprocally from another howitzer are the same as those given in paragraph 4-19. If weapons are equipped with the M100-series panoramic telescopes, the readings between any two weapons will be 3,200 mils apart. To prevent confusion, the gunner on the laying piece adds or subtracts 3,200 mils to or from his reading before announcing it to another howitzer. If the howitzer to which the laying gunner is referring is on his left, the gunner must add 3200. If it is on his right, he must subtract 3200 (left, add; right, subtract [LARS] rule). See Figure 4-13.

e. The methods by which the battery or platoon can be laid are as follows:

(1) Orienting angle. This method requires the use of an M2A2 aiming circle and a known azimuth established by survey.

(2) Grid azimuth. This method requires the use of a declinated M2A2 aiming circle.

(3) M2 compass. This method requires the use of a declinated M2 compass.

(4) Aiming point-deflection. This method requires that an aiming point at least 1,500 meters from the battery or platoon position be visible.

(5) Howitzer back-lay. This method requires the use of a declinated M2 compass and M2A2 aiming circle.

f. The deflection to each weapon should be recorded by the instrument operator for use by the FDC.

Note: The chief of section supervises the laying process and verifies all data after the gunner lays the howitzer.

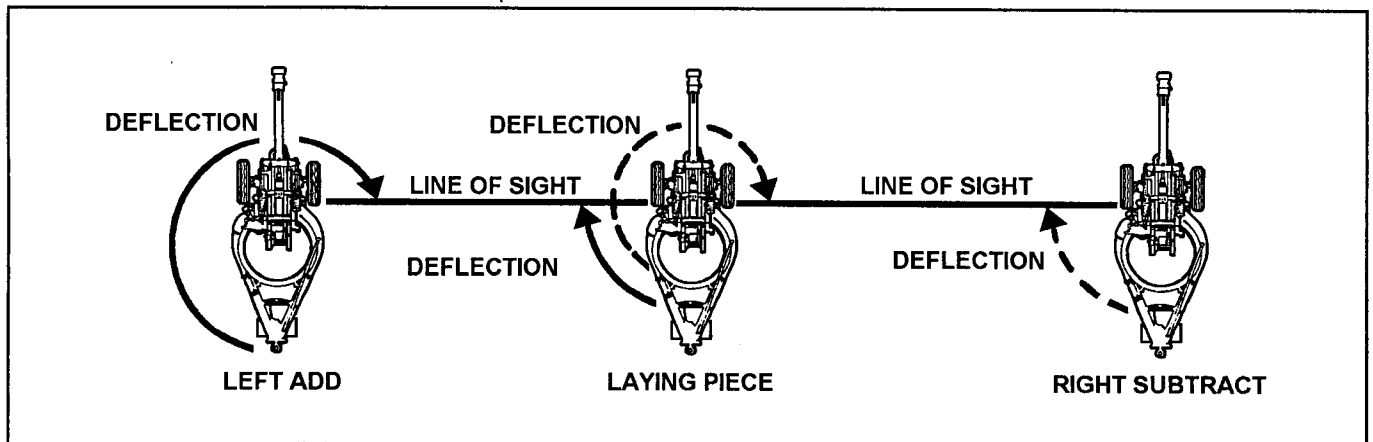

Figure 4-13. Reciprocal laying from another howitzer (M100-series sight)

4-17. LAYING BY ORIENTING ANGLE

a. When occupying a position, it is preferable that all fire support assets have survey data available to them. Common survey enables units to mass fires more accurately. Survey data will not always be available; therefore, all efforts should be made to establish directional control as early as possible.

b. If survey is available, the following, as a minimum, will be provided (Figure 4-14):

- The orienting station (OS), with grid and altitude to the station.
- The azimuth of the orienting line (OL).
- The description of the end of the orienting line (EOL).

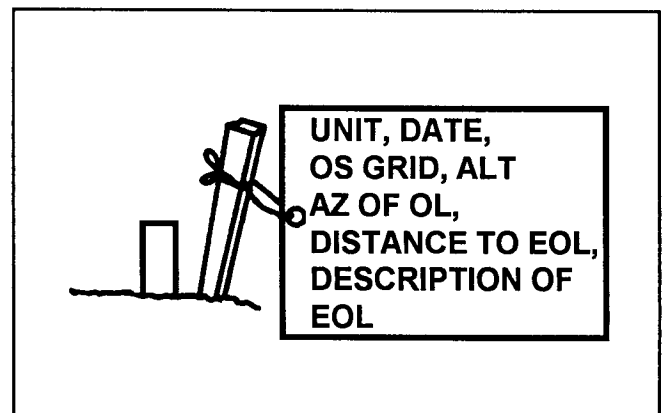

Figure 4-14. Orienting station

c. Steps in orienting angle (OA) method are as follows:

(1) Using the plumb bob, position the aiming circle over the orienting station.

(2) Compute the orienting angle (Figure 4-15) by subtracting the azimuth of fire from the azimuth of the orienting line (add 6,400 mils, if necessary).

(3) With the **upper** motion, set the orienting angle.

(4) Using the **lower** motion, sight on the EOL. The 0-3200 line is now parallel to the azimuth of fire.

(5) Using the **upper** motion, sight on the howitzer pantel.

d. A quick check of survey data prior to laying the battery is recommended, time permitting and METT-T dependent. This check is done in a minimal amount of time and with the same circle which is set up on the OS. Conduct this check in the following manner:

(1) Confirm the location on the OS tag by map spot, GPS, or the most accurate means available.

(2) On the upper motion, set off the declination constant.

(3) On the lower motion, float and center the needle.

(4) On the upper motion, sight in on the EOL. The instrument reading should be the azimuth to the EOL ± 10 mils.

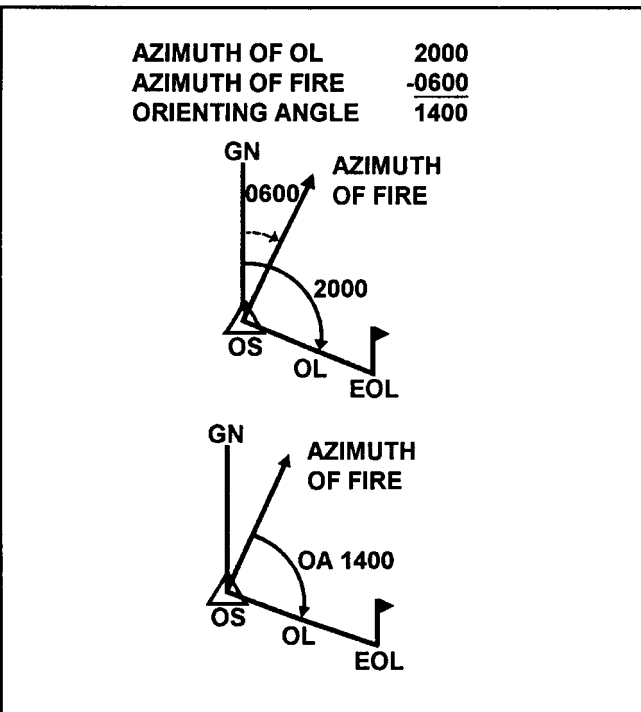

Figure 4-15. Computation of orienting angle

EXAMPLE

Laying by Orienting Angle:

The battery is being laid on azimuth 0600. The azimuth to the orienting line is 2000. Do the following:

- Subtract azimuth of fire (0600) from the azimuth of the orienting line (2000). This gives you the orienting angle 1400. (2000 - 0600 = 1400).
- Set up the aiming circle over the orienting station.
- Roughly orient the 0-3200 line along the azimuth of fire. Using the **upper** motion, set off 1400.
- Using the **lower** motion, sight on the end of the orienting line. The line of sight now coincides with the orienting line. Make certain that the index remains at 1400.
- Now the 0-3200 line of the aiming circle has been established in the desired direction; that is, on the azimuth of fire. The next step is to lay the platoon by using the upper motion. This makes the tubes of the howitzers parallel to the 0-3200 line of the instrument. The howitzers are oriented on the azimuth of fire.

e. Survey may not be available. To establish directional control and lay units by the orienting angle method, the orienting line must be established. Without survey, the orienting line can be established by hasty survey techniques. (See Chapter 5). Once the orienting line is established, the steps shown in c above apply. The OS grid location and altitude may be obtained by GPS, map spot or by hasty traverse.

4-18. LAYING BY GRID AZIMUTH

a. If surveyed data are not available and **hasty survey is not possible**, the next best method of orienting the aiming circle is to use the magnetic needle.

Note: Laying by grid azimuth involves the use of the magnetic needle of the aiming circle. The instrument must be set up where it is free from magnetic attractions. The minimum distances are as follows:

- Power lines and electronic equipment 150 meters
- Railroad tracks, artillery, tanks, and vehicles 75 meters
- Barbed wire, personal weapons, and small metallic objects 10 meters

b. To orient the aiming circle on a grid azimuth by using the magnetic needle, complete the following steps:

(1) Determine the instrument reading (IR) to be placed on the instrument by subtracting the azimuth of fire from the declination constant (DC) of the aiming circle (add 6,400 mils to the declination constant, if necessary).

(2) Place this value on the upper motion.

(3) Using the lower motion, center the magnetic needle. (See Figure 4-7.) The 0-3200 line is now parallel to the azimuth of fire.

c. The next step is to lay the platoon reciprocally by using the upper motion and sighting on the howitzer pantel.

EXAMPLE

Laying by Grid Azimuth:

The platoon is being laid on azimuth 3900. The DC of the aiming circle is 0400 mils. (See Figure 4-16, page 4-16.)

- Subtract the azimuth of fire from the declination constant. The larger number (3,900 mils) cannot be subtracted from the smaller number (0400 mils). So 6,400 mils must be added to the smaller number. Thus, $6400 + 0400 = 6800$ mils; $6800 - 3900 = 2900$. The horizontal, clockwise angle from the desired direction of fire to magnetic north (aiming point) is 2,900 mils.
- Roughly orient the 0-3200 line along the azimuth of fire.
- Using the upper motion, set 2900 (black numbers).
- Center the magnetic needle by using the lower motion. This action places the 0-3200 line of the aiming circle on grid azimuth 3900. Make certain that the index remains at 2900.
- After establishing the 0-3200 line of the aiming circle on grid azimuth 3900, lay the battery reciprocally by using the upper motion. This procedure places each howitzer tube on grid azimuth 3900.

4-19. COMMANDS

The following commands are used in laying a platoon with an aiming circle. The deflections announced are examples only. For brevity, only the exchange between the instrument operator and the gunner of number 3 is given.

Instrument operator:

PLATOON ADJUST, AIMING POINT THIS INSTRUMENT.

(All gunners identify the aiming point. Normally, pieces are laid in the order of their readiness.)

Gunner of number 3:

NUMBER 3, AIMING POINT IDENTIFIED.

(Using the **upper** motion, the instrument operator turns the head of the aiming circle until the line of sight is on the pantel of the number 3. He then reads the azimuth and azimuth micrometer scales.)

Instrument operator:

NUMBER 3, DEFLECTION 3091.

Gunner of number 3:

NUMBER 3, DEFLECTION 3091.

(The gunner, using the two-step deflection method, sets the deflection on his sights and traverses the weapon until he is sighted back on the aiming circle.)

Gunner of number 3:

NUMBER 3, READY FOR RECHECK.

(The instrument operator again turns the head of the aiming circle until the line of sight is on the pantel of the number 3 and announces the deflection.)

Instrument operator:

NUMBER 3, DEFLECTION 3093.

Gunner of number 3:

NUMBER 3, DEFLECTION 3093, 2 MILS.

(This indicates a difference of 2 mils from the previous deflection of 3091, which the gunner had placed on the pantel. The gunner sets 3093 on the pantel and traverses the tube until he is sighted on the aiming circle. Meanwhile, the instrument operator may or may not proceed with the laying of the other pieces. When the gunner of any piece announces a difference of 10 mils or less, the instrument operator normally continues to lay that particular piece until it is laid to zero mils.)

The gunner then announces:

NUMBER 3, READY FOR RECHECK

Instrument operator:

NUMBER 3, DEFLECTION 3093.

Gunner of number 3:

NUMBER 3, DEFLECTION 3093, 0 MILS.

(When the deflection announced by the instrument operator and the deflection on the pantel are identical, the howitzer is laid.)

Instrument operator:

NUMBER 3 IS LAID.

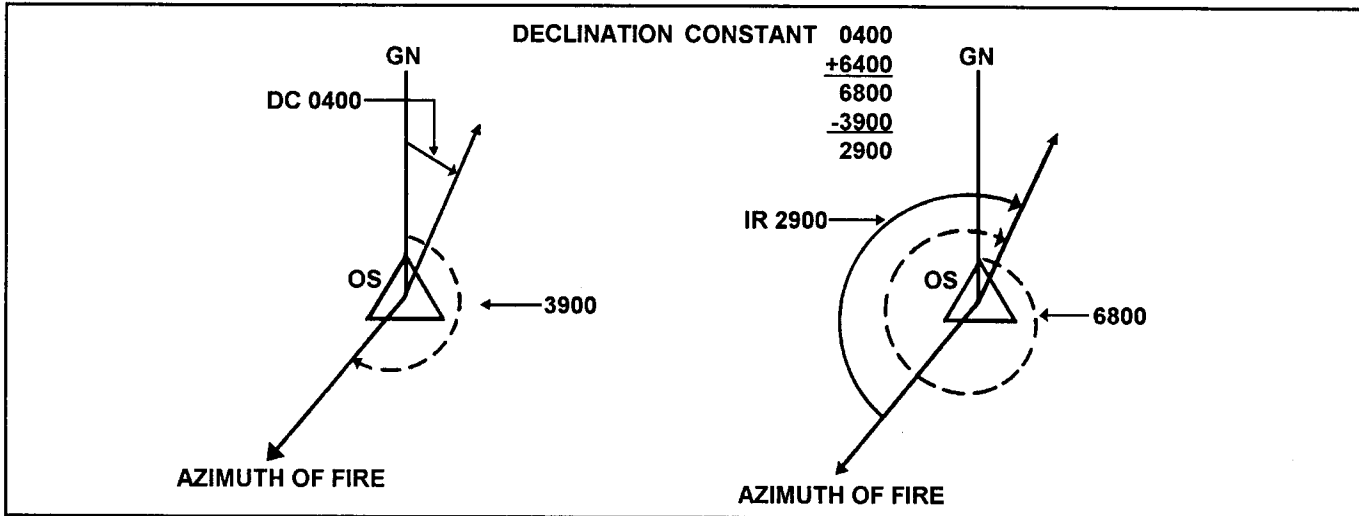

Figure 4-16. Computation of instrument reading

4-20. LAYING BY ALTERNATE METHODS

Based on an ever-changing tactical environment, situations could arise that would make it impractical or impossible to use the primary methods of lay (orienting angle and grid azimuth). In such cases, the firing element must be able to keep supporting the maneuver forces. Alternate methods of lay that give the unit this capability are discussed in paragraphs 4-21, 4-22, and 4-23.

4-21. M2 COMPASS METHOD

a. Normally, this method of lay is used during a deliberate occupation when an aiming circle is not available. The M2 compass is used to lay one howitzer. Once laid for direction, that howitzer is used to reciprocally lay the remaining howitzers.

b. The steps for laying with the M2 compass areas follows:

(1) Place the M2 compass on a stable object (such as a collimator cover, and aiming circle tripod, or a mattock handle) away from magnetic attractions.

Note: Laying by the M2 compass method involves the use of the magnetic needle of the compass. The compass must be set up where it is free from magnetic attractions. The minimum distances are as follows:

| | |
|--|-----------|
| High-tension power lines | 55 meters |
| Field gun, truck, tank | 10 meters |
| Telegraph, telephone, or barbed wire | 10 meters |
| Machine gun | 2 meters |
| Steel helmet or rifle | 0.5 meter |

(2) Measure the azimuth to the panel of the howitzer to be laid.

(3) Determine the deflection to the howitzer by subtracting the azimuth of fire from the measured azimuth (memory aid SAM).

Note: Memory aids for laying are in tables 4-2 through 4-5.

(4) Lay the howitzer by using the command **NUMBER (so-and-so) ADJUST, AIMING POINT THIS INSTRUMENT, DEFLECTION (so much)**.

(The gunner, using the two-step deflection method, sets off the announced deflection on the panel and traverses the tube to pick up a proper sight picture on the compass. He then says **NUMBER [so-and-so], AIMING POINT IDENTIFIED, DEFLECTION [so much]**. This howitzer is now oriented on the azimuth of fire and is laid.)

(5) To lay the remaining howitzers, command: **NUMBER (so-and-so) IS LAID, PLATOON ADJUST, AIMING POINT NUMBER (so-and-so)**.

(The gunner on number [so-and-so] would then reciprocally lay the remaining howitzers in the platoon as outlined in paragraph 4-16d, using the commands in paragraph 4-19.)

c. This method of lay has advantages and disadvantages that must be considered before it is used.

(1) **Advantages.** The main advantage to using this method is that all howitzers will be oriented parallel.

(2) **Disadvantages.** The compass is graduated every 20 mils and can be read to an accuracy of 10 mils. The accuracy depends a great deal on the ability of the instrument operator.

EXAMPLE

Laying by M2 Compass:

The advance party is preparing a position for occupation on an azimuth of 4550. Because of combat loss, no aiming circle is available. The platoon leader has determined that line of sight will exist between number 4 and the remaining howitzers. The gunnery sergeant is told to lay number 4 upon occupation using the M2 compass method of lay. The GSG takes a mattock handle from the advance party vehicle and moves 100 meters to the left front of number 4 position. Upon arrival of number 4, the GSG (using the mattock handles as a stable platform for the compass) measures an azimuth to the pantel of number 4. He subtracts the azimuth of fire from the measured azimuth (adding 6,400 mils to the measured azimuth if necessary).

| | |
|------------------|--------------|
| Measured Azimuth | 0730 |
| | <u>+6400</u> |
| | 7130 |
| Azimuth of Fire | <u>-4550</u> |
| Deflection | 2580 |

The gunnery sergeant commands **NUMBER 4 ADJUST, AIMING POINT THIS INSTRUMENT, DEFLECTION 2580.**

The gunner on number 4 uses the two step deflection method to pick up line of sight on the compass and announces **NUMBER 4 AIMING POINT IDENTIFIED, DEFLECTION 2580.**

The GSG commands **NUMBER 4 IS LAID, PLATOON ADJUST, AIMING POINT NUMBER 4.**

4-22. AIMING POINT-DEFLECTION METHOD

a. Normally, the aiming point-deflection method of lay is used during an emergency fire mission when the need to expedite the mission is more critical than the need for first-round accuracy. A distant aiming point (DAP) is required and must be at least 1,500 meters from the position. (See paragraph D-4.) Also, all howitzers must be able to pick up a line of sight to the DAP. A compass, or a map and protractor are the only equipment needed.

Note: The aiming point-deflection method can be used for a **deliberate** occupation if an aiming circle or an M2 compass is not available. If this method is used for a deliberate occupation, it is desirable to lay only one howitzer by using the DAP. Once that howitzer is laid, the gunner reciprocally lays the remainder of the firing element to ensure all howitzers are oriented parallel.

b. The steps for laying by the aiming point-deflection method are as follows:

(1) Determine the azimuth from the center of the battery or platoon to the DAP (scale from the map or measure with a declinated compass, or use the BCS procedures in paragraph F-11.)

(2) Derive the back-azimuth of fire by adding or subtracting 3,200 mils to or from the azimuth of fire.

(3) Compute a deflection by subtracting the back-azimuth of fire from the azimuth to the aiming point (memory aid: AP-BAF).

(4) To lay the platoon, command **PLATOON ADJUST, AIMING POINT (description), (location), DEFLECTION (so much).**

Each gunner, using the two-step deflection method, picks up a line of sight to the DAP, and announces **NUMBER (so-and-so) AIMING POINT IDENTIFIED, DEFLECTION (so much).**

(5) When all sections have reported, command **THE PLATOON IS LAID.**

Note: During an emergency mission, the X0 or FDO will normally announce the initial fire commands (charge and quadrant) to the adjusting piece. The remaining fire commands will be determined and issued by the FDC.

c. This method has advantages and disadvantages which must be considered before its use.

(1) Advantages.

(a) It is a very rapid method of lay. It may be used immediately upon occupation and only one command is required to lay the entire firing element.

(b) Minimal preparation of the position is required.

(c) The DAP can be used as an aiming point.

(2) Disadvantages.

(a) A DAP must be available.

(b) Line of sight to the DAP may be obscured by smoke, fog, darkness, and so forth.

(c) Howitzers will not be laid parallel when oriented with a common deflection to an aiming point, except when that aiming point is on the left or right flank. If the DAP is to the tint of the position, the sheaf will converge. If the DAP is to the rear of the position, the sheaf will diverge. See Appendix D for further discussion of aiming points.

EXAMPLE

Laying by Aiming Point-Deflection Method:

The XO receives an emergency fire mission while en route to a new position and signals the convoy. The emergency data base is input into a BUCS and the initial firing data are determined. As the firing element approaches the position, the XO notices that there is a water tower located about 4 km to the left flank of the position. Using his map, he scales an azimuth to the water tower.

The XO pulls into position and aligns his vehicle in the general direction of the azimuth of fire. While the howitzers are moving into position, the XO determines the deflection to announce. (He uses the memory aid AP-BAF.)

| | |
|-----------------------------|-------|
| Azimuth of Fire | 0150 |
| ±3200 | +3200 |
| Back azimuth of fire | 3350 |
| | |
| Azimuth to the aiming point | 4925 |
| Minus back azimuth of fire | -3350 |
| Deflection to DAP | 1575 |

After all howitzers are in position and the deflection has been determined, the XO moves to the front of the position and announces **BATTERY ADJUST, AIMING POINT WATER TOWER, LEFT FLANK, DEFLECTION 1575**. Each gunner performs the two-step deflection method, picking up a line of sight to the DAP, and announces **NUMBER (so-and-so) AIMING POINT IDENTIFIED, DEFLECTION 1575**.

When all sections have reported, the XO commands **THE BATTERY IS LAID**.

The XO announces fire commands to the adjusting piece to fire the initial round in the mission. The FDC announces the remaining commands by voice.

4-23. HOWITZER BACK-LAY METHOD

a. Normally, the howitzer back-lay method of lay will be used during an emergency fire mission. It should only be used if the grid azimuth and aiming point-deflection methods are not possible. An M2 compass and an aiming circle are the only equipment needed.

b. The steps for the howitzer back-lay method are as follows:

- (1) Determine the azimuth of fire by using the BCS or LCU hip shoot procedures, or scale it from a map after plotting the target and the proposed firing position.

- (2) Mark the azimuth of fire with stakes and tape.

- (3) Ensure adjusting piece positions are alongside (SP) or over (towed) the marked azimuth, all other howitzers are on line. Ensure the aiming circle is emplaced in the left rear of the position area.

- (4) FDC announces firing data to the adjusting piece, and the first round is fired.

- (5) The instrument operator on the aiming circle commands **NUMBER (so-and-so) (adjusting piece), IS LAID, NUMBER (so-and-so) (adjusting piece), REFER, AIMING POINT THIS INSTRUMENT**.

- (6) The adjusting piece gunner announces **NUMBER (so-and-so) (adjusting piece), AIMING POINT IDENTIFIED, DEFLECTION (so much)**.

- (7) The instrument operator sets the referred deflection on the **upper** motion of the aiming circle. With the **lower** motion, he sights on the panel of the adjusting piece. The 0-3200 line on the aiming circle is now parallel to the howitzer tube after firing the first round. He then lays the remaining howitzers using the upper motion by commanding **PLATOON ADJUST, AIMING POINT THIS INSTRUMENT**.

Note: Normally only one deflection will be read to each howitzer, and the piece is laid.

- (8) Internal battery communications (small-unit transceiver, runners, or wire, whichever is the most expedient) is established.

- (9) The remaining battery/platoon vehicles establish a perimeter defense to the rear of the gun line.

c. This method has advantages and disadvantages which must be considered before its use.

- (1) Advantages

- (a) Firing capability with the adjusting piece is immediate.

- (b) Minimal preparation of position is required.

- (2) Disadvantages

- (a) Laying process is not as timely as other methods.

- (b) If boresight errors exist at adjusting piece, these will be passed onto the remaining howitzers.

EXAMPLE**Laying by Howitzer Back-Lay Method:**

The firing platoon receives an emergency fire mission while en route to a new position and signals the convoy. The BCS operator inputs the target grid into a BCS. He determines the azimuth of fire and the initial firing data using the BCS emergency fire mission procedures. He gives this information to the FDO and the platoon leader. Upon occupation of the position, the platoon leader aligns his vehicle in the general direction of fire. The platoon leader then marks the azimuth of fire for the adjusting piece by using a strip of engineer tape approximately the same length as the weapon system. This tape should have a wooden stake on one end and a nose plug on the other end. To mark the azimuth, the platoon leader throws the nose plug in the direction of the azimuth of fire. Then, using the M2 compass, he aligns the tape on the azimuth of fire by moving the stake end of the tape. At the same time the platoon leader is marking the azimuth, these other actions are taking place:

- The platoon sergeant takes the aiming circle to the left flank of the firing position. He ensures he has moved far enough to the left rear of the weapons so that he is beyond the point where the left flank howitzer will be positioned. He then sets up the aiming circle, levels it, and is prepared to accept a referred deflection from the adjusting piece.
- The chief computer positions the FDC vehicle so that the rear of the vehicle is facing the gun line. This allows the FDC to observe the state of readiness of the firing sections and announce voice fire commands.
- The platoon leader quickly guides the adjusting piece into position where the engineer tape is aligned along the azimuth of fire. Self-propelled weapons drive alongside the line, while towed howitzers are brought in from the direction of fire and centered over the tape.
- The adjusting piece is laid on the target as soon as it is aligned on the engineer tape. The FDC has provided firing data (charge and quadrant) to the platoon leader. These are announced to the adjusting piece, and the first round is fired. The gunner establishes an aiming point.
- As the adjusting piece is preparing to fire the first round, all other howitzers are pulling on line. Positioning is critical. Each chief of section must position his howitzer so that his gunner can see the aiming circle and where the line of sight is not impaired for any other howitzer.
- Immediately after the adjusting piece has fired the initial round of adjustment, the platoon sergeant will command

NUMBER (so-and-so) (adjusting piece) REFER, AIMING POINT THIS INSTRUMENT.

- Upon hearing the above comment, the gunner—
 - Using the azimuth knob, without moving the tube, rotates the head of the pantel and sights on the instrument (or object).
 - Checks the sight mount bubbles, centering them as necessary, and rechecks the sight picture.
 - Reads the deflection appearing on the azimuth counter (M100-series pantels), azimuth and azimuth micrometer scales (M12-series pantels), or azimuth main and micrometer scales (L7A2 pantel).
 - Announces **NUMBER (so-and-so), AIMING POINT IDENTIFIED, DEFLECTION (SO much).**

Note: When referring to the second circle to verify initial lay, the gunner must ensure that the tube is on the azimuth of fire before he uses the above procedures.

- The platoon sergeant sets the referred deflection on the upper motion of the aiming circle and with the lower motion, sights on the pantel of the adjusting piece. The platoon sergeant is now ready to lay the remaining pieces of the platoon.
- Each gunner identifies the aiming point and receives his deflection. The deflection is set off, the tube traversed until his line of sight is back on the aiming circle, and the piece is laid. In the interest of time, there normally are no rechecks. If the initial target location was good and if the platoon leader accurately laid out the azimuth tape, the second volley may well be fire for effect.
- An aiming point is established for each weapon.
- The platoon sergeant should remain at the aiming circle during the firing of the mission in case a weapon must be re-laid or the lay of the platoon needs to be refined.
- The platoon leader, using his M2 compass, should visually check the gun line to ensure that there is no gross error in the lay of the weapons.

4-24. ESTABLISHING AIMING POINTS

a. During deliberate and hasty occupations, after the battery has been laid, the crew of each piece sets up the collimator and/or emplaces aiming posts before the tube is moved. The deflection at which the aiming points are established is recorded by each gunner. The direction in which the battery is initially laid and the corresponding common deflection are used as references from which the FDC can derive firing deflections for future targets.

Note: For further discussion on aiming points, see paragraph D-4.

b. The collimator is the primary aiming point and is placed 4 to 15 meters from the sight of the weapon. When the collimator is emplaced, 3 numbers (5, 0, 5) and 11 graduations will be visible in the reticle. If possible, place the collimator under cover to the left front or left rear of the weapon. See Figure 4-17 for the proper sight picture.

c. When aiming posts are used, the far aiming post should be placed 100 meters from the howitzer and the near aiming post should be placed 50 meters from the howitzer. If the situation or terrain limits placing the far aiming post 100 meters from the howitzer, place it out as far as possible and place the near aiming post halfway between the howitzer and the far aiming post.

d. As soon as the platoon is laid and the aiming point(s) is (are) emplaced, the platoon leader should have the gunners of all pieces refer to a distant aiming point if one is available. A DAP must be at least 1,500 meters away. This DAP can be used as the primary aiming point if something happens to the collimator or aiming posts.

e. Close-in aiming points are moveable, established by battery personnel, and can be seen at night. The DAP has the advantage of being readily available upon occupation of a firing position.

f. During an emergency occupation, it is recommended that a distant aiming point be selected. If a DAP is not available, then several other options can be used. Two examples are as follows:

- Set up the collimator.
- Set up an aiming post at a point halfway between the aiming circle and the panel.

4-25. SAFETY AND VERIFYING THE LAY OF THE PLATOON

a. Safety and verification of tasks by leaders are disciplines that exist in the field artillery, regardless of whether operations are performed in combat or in peacetime. For every task that is performed, there is another person in a leadership position (section chief, platoon sergeant, platoon leader or XO, FDO, or BC) who verifies the accuracy of the action performed. This system of double checks is inherent in all operations and is not to be considered a limiting factor in providing timely fire support. Therefore, commanders must ensure that their units have a system of independent safety checks. These checks ensure that all cannon battery and platoon operations (for example, FDC mission processing and orienting howitzers for direction) affecting firing is checked by someone other than the person who performs the action. Though most independent checks take place before missions are received, **performing independent checks is a continuous process and must be rigidly enforced to ensure fires are timely, accurate, and safe.** These checks may include, but are not limited to, the following:

- Verification of entered azimuth of lay (LCU or BCS) by the FDO and the platoon leader.
- Verification of target grid.
- Verification of battery or platoon lay.
- Verification of AFCS data (Paladin units only).
- Verification of weapon location.
- Verification of met data.

b. During a deliberate occupation, the lay of a unit is verified immediately following the verification or conduct of boresighting. It is the "S" step in TLABSPAP. The unit SOPs will specify the method and sequence of verifying lay during an emergency occupation.

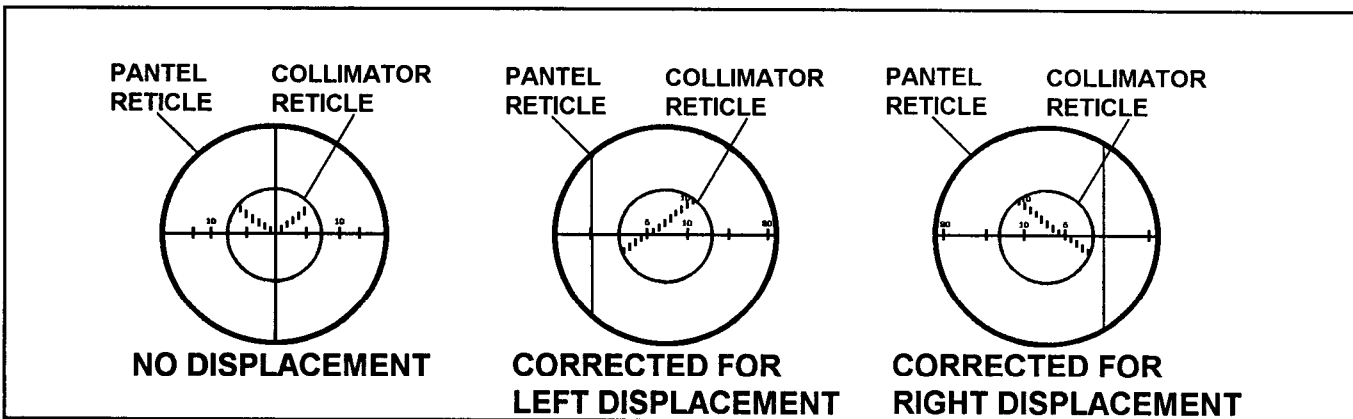

Figure 4-17. Proper sight picture from the weapon

c. After the platoon is laid, the platoon leader verifies the lay by use of another M2A2 aiming circle referred to as the verification circle. To verify lay of the platoon, the following steps are taken:

(1) The platoon leader or designated safety officer sets up and orients an M2A2 aiming circle by using a method other than that used by the lay circle. However, in combat situations, the BC may authorize the orientation of the verification circle using the same method as the lay circle, METT-T dependent. This aiming circle must be located where it can be seen by all howitzers and should not be any closer than 10 meters to the lay circle.

(2) The verification circle operator picks up a line of sight on the lay circle. Then he commands, **LAY CIRCLE REFER, AIMING POINT THIS INSTRUMENT**. The lay circle operator will sight his instrument onto the verification circle by use of the recording motion.

(3) If the lay circle and the verification circle deflections are within 10 mils or as specified by local range regulations, the instrument operator on the verification circle places the deflection read by the lay circle on the **upper** motion of the verification circle. With the **lower** motion, he sights back on the lay circle. This serves to align the 0-3200 line of the verification circle parallel to the 0-3200 line of the lay circle.

Note: When an aiming circle is used to verify another aiming circle for direction, the readings between the two circle will be 3,200 mils apart (Figure 4-18). This is because both circles measure horizontal clockwise angles from the line of fire. To prevent confusion remember that, if you see red, read red.

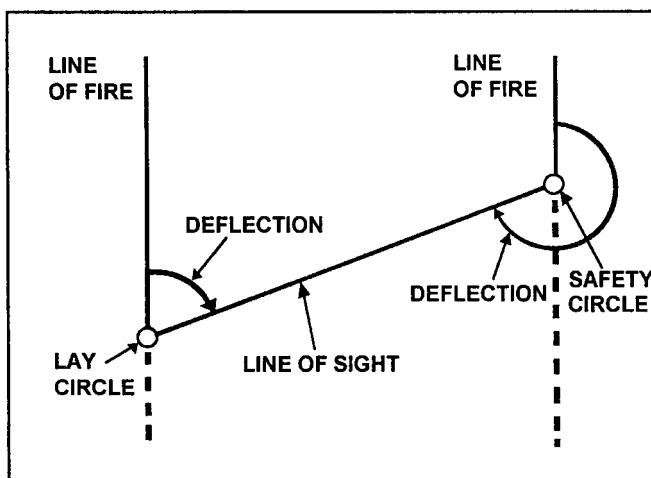

Figure 4-18. Orienting the verification circle

(4) The instrument operator on the verification circle commands **PLATOON REFER, AIMING POINT THIS INSTRUMENT**. All gunners refer and announce the deflection referred to the verification circle. If the deflection referred by a howitzer is within that tolerance given in the local range regulations, the operator on the verification circle announces that the howitzer is safe. Once all howitzers are safe, the operator announces **THE PLATOON IS SAFE**.

Note: When referring to the verification circle to verify lay, the gunner must ensure that the tube is on the azimuth of fire before he uses the above

d. The platoon leader should walk the gun line and visually check the tubes to ensure they are parallel. An M2 compass should also be used to ensure the tubes are on the azimuth of fire.

4-26. MEASURING VERTICAL ANGLES

a. Normally, vertical angles (VAs) from the M2A2 aiming circle to the howitzers are measured during advance party operations. The VA and distance from the orienting station to each howitzer are required by FDC to determine piece locations in BCS or LCU. The aiming circle can also be used to determine sight to crest at each howitzer during advance party operations.

b. The VA to a point is measured from the horizontal plane passing through the horizontal axis of the instrument (M2A2 aiming circle). It is expressed as plus or minus, depending on whether the point is above (plus) or below (minus) the horizontal plane. It is measured to the height of instrument which is about chest high on the average individual at the gun position. The steps for measuring a VA are as follows:

(1) Using the circular leveling vial, ensure the aiming circle is properly set up and leveled.

(2) Using the elevation knob, center the upper tubular leveling vial. This yields a correction factor to be applied to all measured vertical angles.

(3) Read and record the corrections from the elevation scale. If black numbers are used, the correction factor is plus; if red numbers are used, the correction factor is minus.

(4) While measuring the subtense (used to determine distance), elevate or depress the telescope to place the horizontal cross hair of the aiming circle on the chest of the gun guide. The subtense method is described in paragraph 5-10a.

Note: If there was not enough time to measure VAs during advance party operations, the instrument operator can align the horizontal cross hair at chest level of a cannoneer during occupation. The key is to measure the VA at a height that approximates instrument height.

(5) Read and record the value on the elevation and elevation micrometer scales to the nearest 1 mil.

(6) Subtract the correction (corr) factor from the reading obtained in the preceding step. The result is the vertical angle for that howitzer.

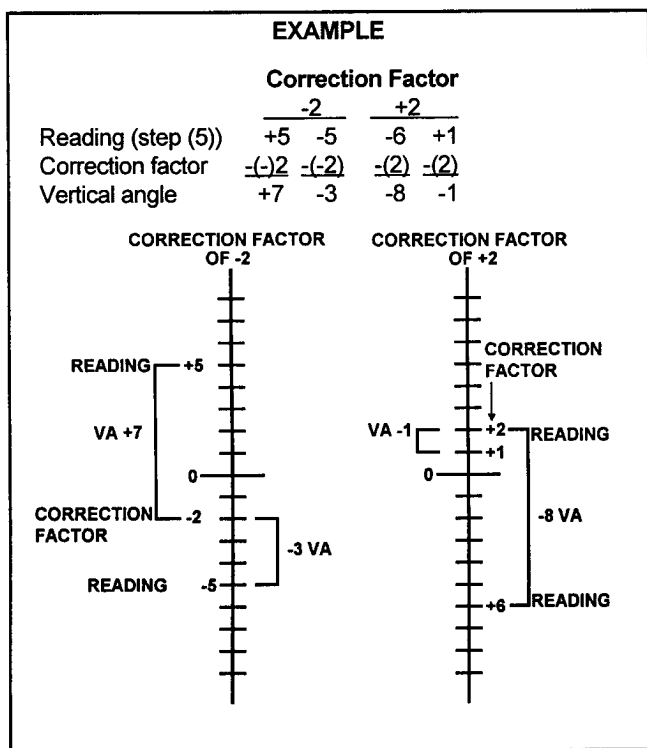

4-27. MEMORY AIDS

Tables 4-2 through 4-5 (page 4-24) show memory aids for use in training personnel to lay the battery and/or platoon.

Table 4-2. Laying with the M2A2 aiming circle

| SEQUENCE | MEMORY AID | STEPS |
|---|---|---|
| Survey is Available | | |
| Do this first | TFOOL (Take the azimuth of Fire Out of the Orienting Line) | Math step: Subtract the azimuth of fire from the azimuth of the OL. |
| Do this second | U | Set the remainder (OA) on the upper motion. |
| Do this third | L | With the lower motion, sight on the EOL. |
| Do this last | U | With the upper motion, sight on the EOL. |
| Note: You must use the azimuth of the OL and the azimuth of fire. | | |
| No Survey is Available | | |
| Do this first | SAD (Subtract the Azimuth of fire from the Declination constant) | Math step: Subtract the azimuth of fire from the declination constant (DC). |
| Do this second | U | Set the remainder (instrument reading) on the upper motion. |
| Do this third | L | With the lower motion, center the magnetic needle. |
| Do this last | U | With the upper motion, sight on the panel of the weapon. |
| Note: You must use the declination constant and the azimuth of fire. | | |

Table 4-3. Laying with the M2 compass

| SEQUENCE | MEMORY AID | STEPS |
|--|--|--|
| Do this first | SAM (Subtract the Azimuth of fire from the Measured azimuth) | Math step: Subtract the azimuth of fire from the azimuth measured to the weapon panel. |
| Do this second | | Using the proper commands, announce the resulting deflection to the weapon. |
| Do this last | | The weapon that was laid by the M2 compass will lay the rest of the unit reciprocally. |
| Note: You must use the azimuth to the weapon measured with the compass and the azimuth of fire. | | |

Table 4-4. Laying by the aiming-point deflection method

| SEQUENCE | MEMORY AID | STEPS |
|---|---|---|
| Do this first | AP-BAF (azimuth to the Aiming Point minus the Back Azimuth of Fire) | Subtract the back azimuth of fire from the azimuth to the aiming point. |
| Do this second | | Using the proper commands, announce the resulting deflection to the unit. |
| Note: You must use the azimuth to the DAP and the azimuth of fire. | | |

Table 4-5. Laying by the howitzer back-lay method

| SEQUENCE | MEMORY AID | STEPS |
|---|--------------------------|--|
| Do this first | | Set up the aiming circle where it can be seen by all howitzers, and level it. |
| Do this second | Panel L Ays You | After the adjusting piece fires the first round, command the gunner to refer to the aiming circle. |
| Do this third | U | With the upper motion, place the referred deflection on the aiming circle. |
| Do this fourth | L | With the lower motion, sight on the panel of the adjusting piece. |
| Do this last | U | With the upper motion, lay the rest of the unit. |
| Note: Using the M2 compass, align engineer tape (with a wooden stake at one end and a nose plug at the other) on the azimuth of fire, and position the adjusting piece parallel to the tape. | | |

Section VI

MEASURING AND REPORTING DATA

4-28. ACCURACY

a. The accuracy of lay is directly related to the method used to orient the howitzers on the azimuth of fire and the alignment of the fire control equipment.

b. Measuring and reporting data provides us with a method of correction for errors in the lay. The FDC may require a check of weapon direction be made. Normally this check is made after a registration or after survey control is established. It serves to—

- Check the data fired.
- Check the accuracy of lay.

c. Weapon direction may be verified by-

- Reporting the correct deflection.
- Measuring the azimuth.
- Measuring the orienting angle.

d. Reporting will reveal any sloppy procedures being used by the gun crews, such as failure to level the bubbles and improper sight picture. Measuring provides a check on the accuracy of the lay. These checks must be made before END OF MISSION is received at the firing weapon.

4-29. BACKWARD AZIMUTH RULE

a. The backward azimuth rule is a mathematical relationship used to apply equal changes in angles used in the laying process. This rule establishes the relationship between three elements as follows:

An increase in deflection causes an equal decrease in azimuth and an equal increase in orienting angle. A decrease in deflection causes an equal increase in azimuth and an equal decrease in orienting angle.

b. Using this rule and assuming that there are no errors in the lay of the weapons, weapon direction may be verified.

4-30. REPORTING THE CORRECT DEFLECTION

Upon completion of a mission, and before announcing END OF MISSION the FDC may request that the executive officer or platoon leader report the correct deflection. To report, the XO or platoon leader—

- Goes to the weapon.

- Checks the level of the bubbles (centers if necessary).
- Checks for the correct sight picture (corrects if necessary).
- Reads the deflection from the pantel.

CAUTION

When making corrections to the sight picture or leveling the bubbles, the tube must not be moved.

- Reports the deflection read from the pantel to the FDC as **CORRECT DEFLECTION (so much)**.

EXAMPLE

Your platoon (M109A3, 155-mm SP) is laid on azimuth 5000 (orienting angle 0600), with a common deflection of 3200. After firing a registration, FDC requests that the platoon leader report the azimuth or orienting angle. The platoon leader completes the required check sand reports **CORRECT DEFLECTION 3250**. He then does the following:

Determines the change between the common deflection and the correct deflection. (Common deflection= 3200; correct deflection= 3250; increase = 50 mils.)

Applies the difference according to the backwards azimuth rule to determine the azimuth fired. (Deflection= +50 mils; azimuth= .50; mils; 5000 - 50 = 4950.)

Reports **CORRECT AZIMUTH 4950**.

4-31. MEASURING THE AZIMUTH OF THE LINE OF FIRE

a. If a gun fires out of safe, the platoon leader or XO may wish to determine the azimuth at which the round was fired. This is the most common reason for measuring the azimuth of the line of fire. Another reason is that a unit may use a less desirable method of lay and then improve this method. An example would be a unit that lays by the grid azimuth method because there is no survey control. When survey closes, the unit will want to know if the azimuth of fire it has been firing on is different from the originally intended azimuth of fire. There are two methods of measuring the azimuth of the line of fire. The difference depends upon whether or not survey control is available.

b. If the line of fire is being measured following a firing incident, the crew of the howitzer in question will not move the tube but will simply refer to the aiming circle. If, on the other hand, the platoon leader wishes to measure the azimuth of fire, he must first ensure that the tube of the howitzer being measured is at lay deflection.

c. These steps are performed first, regardless of whether or not survey control is available:

(1) The aiming circle operator—

- Orients the 0-3200 line generally parallel to the tube of the weapon.
- Commands **NUMBER (so-and-so) REFER, AIMING POINT THIS INSTRUMENT.**

Note: Memory aids for measuring and reporting are in tables 4-6 through 4-8, page 4-28.

(2) The gunner measures the deflection to the aiming circle without moving his tube and announces **NUMBER (so-and-so), AIMING POINT IDENTIFIED, DEFLECTION (so much).**

(3) The aiming circle operator—

- Sets the announced deflection off on the **upper** (recording) motion of the aiming circle.

Note: If the weapon has an M12-series sight, the referred deflection may have to be set on the aiming circle by using the red numbers. A general rule is that if a weapon with an M12-series sight is left and forward of the aiming circle, red numbers are used when reading the aiming circle to lay the howitzer.

- With the **lower** (nonrecording) motion, sights in on the panoramic telescope.

Note: The 0-3200 line of the aiming circle is now parallel to the tube of the firing weapon.

(4) The final step at the aiming circle depends on whether survey control is available. If it is not available, follow the steps in subparagraph d below. If it is available, follow those in subparagraph e below.

d. The following is the final step if survey control is not available:

(1) The platoon leader, with the **upper** (recording) motion, floats and centers the magnetic needle.

Note: Since the magnetic needle is being used, the aiming circle must be declinated and set up away from magnetic attractions.

(2) The value now on the upper motion is the instrument reading. Subtract the instrument reading from the declination constant. The difference is the azimuth of the line of fire (az of the LOF). For a memory aid, see Table 4-6, page 4-28,

EXAMPLE

Your M198 platoon conducted an emergency occupation using the howitzer backlay method to lay on an azimuth of fire of 0900. You were instructed to stay in position and continue answering calls for fire. The platoon is at end of mission, and all howitzers have returned to their lay deflections. You go to the aiming circle and measure an instrument reading of 5750. The aiming circle has a declination constant of 0300. Your final step is to solve for the azimuth of the line of fire.

DC(+6400 if needed)- IR= az of the LOF
(0300+6400)-5750=0950

Your platoon howitzers were initially laid on 0950, but your BCS or LCU currently has an azimuth of fire entry of 0900. You have two options at this point

- Leave the platoon laid on 0950, and have the FDC correct the computer entries for azimuth of fire and piece locations.
- Re-lay the platoon on the originally intended azimuth of 0900.

Note: The first option requires less time and effort and is thus normally preferred if the tubes were laid parallel. However, if the unit was laid by an alternate method of lay where the tubes are not truly parallel, then re-laying would be preferred.

e. If survey control is available, the following is the final step:

(1) The platoon leader with the **upper** (recording) motion, sights in on the end of the orienting line.

(2) The value now on the upper motion is the orienting angle. Subtract the orienting angle from the azimuth of the orienting line. The difference is the azimuth of the line of fire. For a memory aid, see Table 4-7, page 4-28.

EXAMPLE

Your battalion FDC has instructed you to continue firing from your present position. A survey team is on its way to put you on common survey. In preparation, you place an OS marker directly below the aiming circle plumb bob. You also establish an EOL at least 100 meters away. Upon closing, the survey team provides you with a grid to your OS and an azimuth to the EOL of 5,363 mils. With the howitzers at their lay deflections, you now measure the OA of 4400. Your final step is to solve for the azimuth of the line of fire.

$$OL (+ 6400 \text{ if needed}) - OA = \text{az of the LOF}$$

$$5363 - 4400 = 0963$$

Your platoon howitzers have been laid on 0963 all along. You have two options at this point:

- Leave the platoon laid on 0963, and have the FDC correct its computer entries for azimuth of fire and piece locations.
- Re-lay the platoon on the originally intended azimuth.

Note: The first option requires less time and effort and is thus normally preferred if the tubes were laid parallel. However, if the unit was laid by an alternate method of lay where the tubes are not truly parallel, then re-laying would be preferred.

pantel and the **tube is traversed onto the aiming point.** The relationship made at the time of lay is now reestablished. It is **improper**, after correcting for boresight error, to move (or **fine tune**) the aiming point to the tube in relation to the deflection (numbers) originally established at the time of lay.

b. Emergency occupation of a firing position may require firing before boresight is verified and any error is corrected. In such cases, the howitzers must verify boresight as soon as possible. If this verification discloses an error (the 0-3200 line of the pantel and the howitzer tube are not parallel) the platoon leader takes corrective actions after measuring the error and reporting it to the FDC.

c. When a deflection is read from the pantel or when an azimuth is measured, the deflection or azimuth determined is that of the 0-3200 line of the pantel as read from the azimuth counter. When the FDC requests the platoon leader to **MEASURE THE AZIMUTH**, the azimuth requested is that of the howitzer tube. If the howitzer is out of boresight, the data derived is inaccurate by the amount of the error.

Note: If the howitzer in question was used to lay the aiming circle or the rest of the howitzers, the other howitzers are out of lay by the amount of error found. The platoon leader should take corrective action to orient them on the correct azimuth of lay (after all howitzers have verified foresight).

4-32. CORRECTING BORESIGHT ERROR

a. If the battery or platoon is to deliver accurate fire, the boresight of the weapon must be correct. Boresighting is the process of ensuring that the optical axis of the weapon sights are parallel to the cannon tube. The primary methods of boresighting are the distant aiming point, test target, and standard angle.

(1) If a howitzer is not in boresight, the tube is disoriented in relation to the amount of boresight error. If the sight is off to the right, the tube is disoriented by that amount to the left. If the sight is off to the left, the tube reflects that error to the right.

(2) Once a weapon is properly boresighted, the deflection to an aiming point (aiming circle or collimator) is reestablished. The angle (deflection) between aiming point and pantel **has not changed** from when the weapon was laid. The entire angle has simply rotated by the amount of boresight error. Since the angle has not changed, the deflection recorded to the aiming point is set off on the

d. Boresight is verified as discussed below.

(1) Howitzers with an alignment device.

(a) The azimuth counter (not the reset counter) and the appropriate alignment device are used when verifying boresight. The numerical error of boresight can be determined from the azimuth counter. The amount of error is the difference between the required deflection for the alignment device (according to the -10 manual) and the deflection read (on the azimuth counter) once the vertical hairline has been aligned.

(b) The backwards azimuth rule will be used to determine the correct azimuth of the howitzer tube.

(c) Once the error has been measured and reported the platoon leader directs the following actions to be taken to correct the error.

- Boresight the weapon.
- Correct the azimuth of lay and piece location in the FDC or re-lay the piece.

(2) Howitzers without an alignment device.

(a) The azimuth scale (nonslipping) is used during boresighting. The tube is pointed at the aiming point when a DAP or test target is used. If the sight is pointed to the right of the aiming point the tube is pointed to the left of the 0-3200 line of sight. Before this correction is made, any azimuth measured will be greater than the azimuth of the tube and any orienting angle will be smaller than the true orienting angle. (The opposite relationship also exists.)

(b) The amount of error is determined by referring the sight to the aiming point and reading the deflection. This deflection is compared with the deflection used for boresighting and the difference is the amount of error in boresight. The XO applies the appropriate correction for the boresight error to the measured azimuth or orienting angle prior to reporting to the FDC. He corrects the lay of the pieces as required.

4-33. TRAINING

Training in the proper methods of determining and reporting data should be part of training personnel to lay the platoon. Tables 4-6 through 4-8 will help personnel remember procedural steps. These procedures are performed with the aiming circle and the howitzer panel.

Table 4-6. Measuring the azimuth (without survey control)

| SEQUENCE | MEMORY AID | STEPS |
|---|---|---|
| Do this first | U | Place the deflection read to you from the howitzer on the upper motion of your aiming circle. |
| Do this second | L | With the lower motion, sight on the howitzer panel. |
| Do this third | U | With the upper motion, center the magnetic needle. |
| Do this fourth | SID (Subtract the Instrument reading from the Declination constant) | Math step: Subtract the instrument reading (on the AC) from the declination constant. |
| Do this last | | Report the measured azimuth to the FDC. |
| Note: You must use the deflection given to you from the howitzer and the declination constant. | | |

Table 4-7. Measuring the orienting angle (with survey control)

| SEQUENCE | MEMORY AID | STEPS |
|--|--|--|
| Do this first | U | Place the deflection read to you from the howitzer on the upper motion of your aiming circle. |
| Do this second | L | With the lower motion, sight on the howitzer panel. |
| Do this third | U | With the upper motion, sight on the EOL. |
| Do this fourth | SOL (Subtract the Orienting angle from the orienting Line) | Math step: Subtract the orienting angle (on the AC) from the azimuth of the orienting line. |
| Do this last | Report the measured azimuth to the FDC. | |
| Note: You must use the deflection given to you from the howitzer. | | |

Table 4-8. Reporting

| SEQUENCE | STEPS |
|----------------|---|
| Do this first | Go to the howitzer. |
| Do this second | Check to ensure that the bubbles on the sight mount are level. If they are not, level them with the leveling knobs. |
| Do this third | Check the sight picture. If incorrect, correct it by moving the head of the panel only. Do not traverse the tube. |
| Do this last | Read and report the deflection on the panel. |

CHAPTER 5
HASTY SURVEY TECHNIQUES

Section I
SURVEY CONTROL

5-1. REQUIREMENTS

a. Common survey reduces the amount of survey error between fire units. Although the survey may contain errors, survey related error is considered to be constant. Common survey is required to accurately mass fires. Normally, accurate survey data are provided as time and the tactical situation permit. However, sometimes accurate survey data are not available. Errors in firing, due to a lack of survey control, can be eliminated by registration. However, registrations may not be possible or practical due to security and ammunition considerations. Consequently, battery supervisors must be proficient in the use of the hasty survey techniques described in this chapter. Thus, they can provide their own survey control, effectively mass fires, and deliver effective unobserved fires.

b. If accurate survey data are not available, the procedures described in this chapter will enable firing units to establish acceptable survey control.

5-2. ELEMENTS OF SURVEY CONTROL

a. The three elements of survey control are direction, location, and altitude.

(1) Direction. This is the most important element of common survey. The inherent error is directly related to the range to each target. The mil relation formula states that 1 mil of error in direction at 1,000 meters will result in a lateral deviation from the target of 1 meter.

EXAMPLES

A 1 mil error at 10,000 meters will result in a deviation from the target of 10 meters.

A 10 mil error at 10,000 meters will result in deviation from the target of 100 meters.

An error such as the one in the last example will cause the rounds to have little, if any effect on the target. (See paragraph D-9.)

(2) Location. Accurate location of the firing unit is second in order of importance. When higher order survey techniques are used to establish the firing unit location, a high degree of accuracy is assured. An alternative is to estimate, by map spot, the location of the firing unit. If the unit's position is map-spotted, for example, 200 meters too far to the east, the initial rounds will impact 200 meters to the east of the actual location of the target.

(3) Altitude. Altitude is the last of the three elements of survey control. If not established by formal survey procedures, it must be obtained through the use of contour lines on the map sheet covering the area of operations. Generally, a map spotted altitude introduces only a minor error into the computation of site.

b. The hasty survey techniques discussed in this chapter fall into two categories-directional control and determining location.

Section II
DIRECTION

5-3. SIMULTANEOUS OBSERVATION

a. Simultaneous observation (SIMO) of a celestial body is a fast and easy method of transferring directional control. It is ideally suited for field artillery units, because many units can be placed on common directional control in minutes. The principle of simultaneous observation is that any celestial body is so far away that, for practical purposes, the lines of sight to it from two or more points on the surface of the earth are parallel (Figure 5-1).

Note: For units equipped with BUCS revision 1 ROMs, a similar technique known as a hasty astro will provide accurate directional control. A hasty astro has the advantage of not requiring a master station or radio communications as the simo does. Step-by-step procedures for conducting the hasty astro technique are listed in FM 6-2 and in the BUCS revision 1 job aids (ST 6-40-31).

b. During daylight, the sun is used for observation. At night, any predetermined celestial object may be tracked. Simultaneous observation requires the following:

- Clear weather that permits observation of a celestial object.

- Communications between the master and the flank stations.
- Known directional control (a grid azimuth to known point).
- Distance between the master and flank stations cannot exceed 26 km (distances greater than 26 km may result in exceeding hasty survey direction tolerances of ± 2 mils).

c. Procedures for the conduct of a SIMO are:

(1) The point having known directional control (a grid azimuth to a known point) becomes the master station. It can be occupied by survey personnel or personnel from the firing unit. All positions requiring the establishment of directional control become flank stations.

CAUTION

Place the sun filter over the aiming circle eyepiece before tracking the sun.

(2) The M2A2 aiming circle at the flank station is set up to observe the prearranged celestial object. It becomes the orienting station for the firing unit. If the SIMO is prearranged, the flank station can maintain radio silence during the procedure.

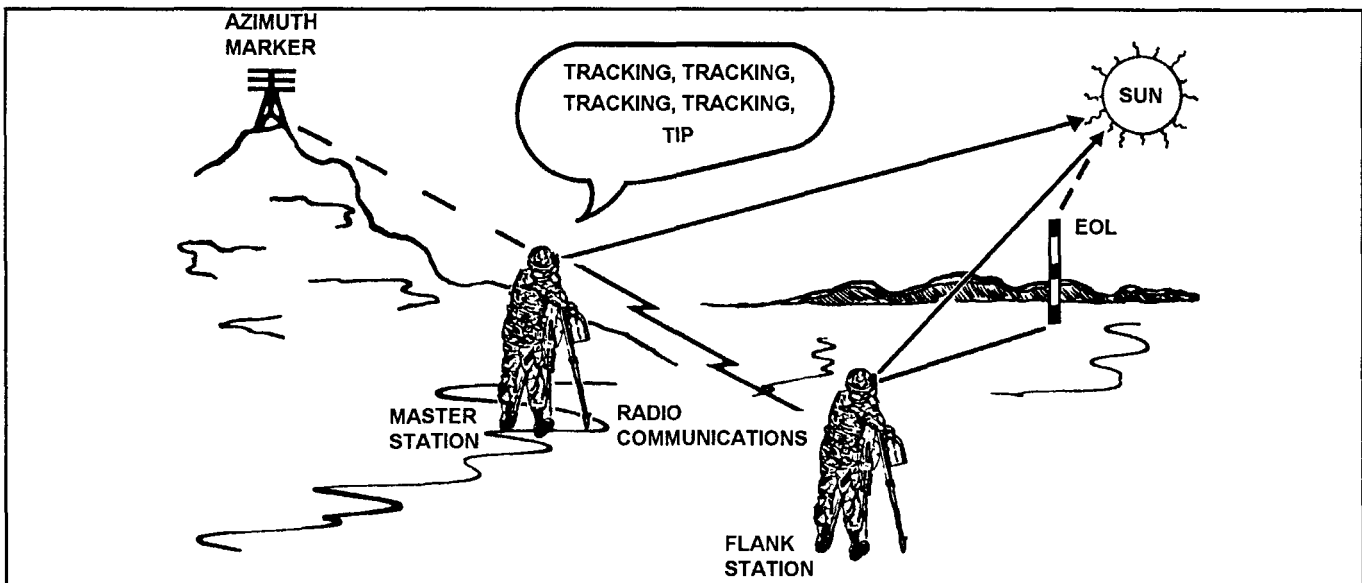

Figure 5-1. Simultaneous observation

(3) The specific steps for the master station and the flank station(s) and sample radio communications for SIMO are shown in Table 5-1.

5-4. POLARIS-KOCHAB METHOD

a. Observation of Polaris is another technique for establishing directional control to within 2 mils. It is simple, fast and has the distinct advantage of requiring no radio or wire communications. The instrument operator must be trained in finding the stars Polaris and Kochab, which are in the constellation known as Ursa Minor (Little Dipper).

(1) Polaris. Polaris is one of the two brightest stars in the constellation Ursa Minor. Because it appears to move

in a small elliptical orbit about the North Pole, it is commonly referred to as the North Star. Polaris is the last star in the handle of the Little Dipper as shown in Figure 5-2, page 5-4. Two stars in the bowl of the Big Dipper actually point toward Polaris and are called the Pointers. Polaris is approximately five times the distance between the Pointers along an imaginary line from the Big Dipper. On the side opposite the Little Dipper is the constellation Cassiopeia, which looks like a lazy W.

(2) Kochab. The second star needed to perform the observation is Kochab, which is the other bright star (as bright as Polaris) in the Little Dipper. It is the front star of the bowl and is the only bright star between Polaris and the Big Dipper. Of the two front stars in the bowl of the Little Dipper, Kochab is the brighter and the closer to Polaris.

Table 5-1. Simultaneous Observation Procedures

| MASTER STATION | FLANK STATION(S) |
|--|--|
| STEP 1. Set the known azimuth value on the instrument scale (upper [recording] motion), and sight on the known point or azimuth mark with the lower (nonrecording) motion. | STEP 1. With the upper motion, set 0.0 mils on the aiming circle. |
| STEP 2. Using the upper motion, identify and sight on the predetermined celestial object. ¹ THIS IS NOVEMBER 38, START TRACKING, OUT. | STEP 2. Contact the master station, and report that you are ready to observe. NOVEMBER 38, THIS IS NOVEMBER 37, READY TO OBSERVE, OVER. |
| STEP 3. Using the upper motion, track the celestial object and announce TIP. ² THIS IS NOVEMBER 38, TRACKING, TRACKING, TRACKING, TIP, OUT. | STEP 3. With the lower motion, sight on and track the celestial object until the master station announces TIP. |
| STEP 4. Read the azimuth to the celestial object from the azimuth scale, and announce it to the flank stations(s). THIS IS NOVEMBER 38, AZIMUTH 3741.5, OVER. | STEP 4. Depress the telescope of the aiming circle, and place the EOL squarely along the aiming circle line of sight at least 30 meters away from the OS. Record the azimuth that is announced by the master station. |
| STEP 5. Repeat steps 2 and 3, and determine a second angle for verification. THIS IS NOVEMBER 38, TRACKING, TRACKING, TRACKING, TIP, OUT.³ | STEP 5. With the upper motion, track the celestial object until the master station announces TIP. |
| STEP 6. Determine the clockwise angle (the check angle) between the first and second azimuths. Announce the check angle to the flank station(s). THIS IS NOVEMBER 38, CHECK ANGLE 2 MILS, OUT. | STEP 6. Read the angle that was measured (read the horizontal scale), and copy the check angle from the master station. |
| | STEP 7. Ensure that the check angle from the master station and the horizontal scale of the aiming circle agree within ± 2 mils, the azimuth to the EOL is the azimuth that was recorded in step 4. If the check angle is out of tolerance, the entire procedure must be repeated. |

¹ Sight on the center mass of the celestial object. With the M2A2 aiming circle, you can see celestial objects even when they are only half visible to the naked eye.

² TIP = telescope in place

³ The second TIP on the celestial object serves to verify the accuracy of the orienting line.

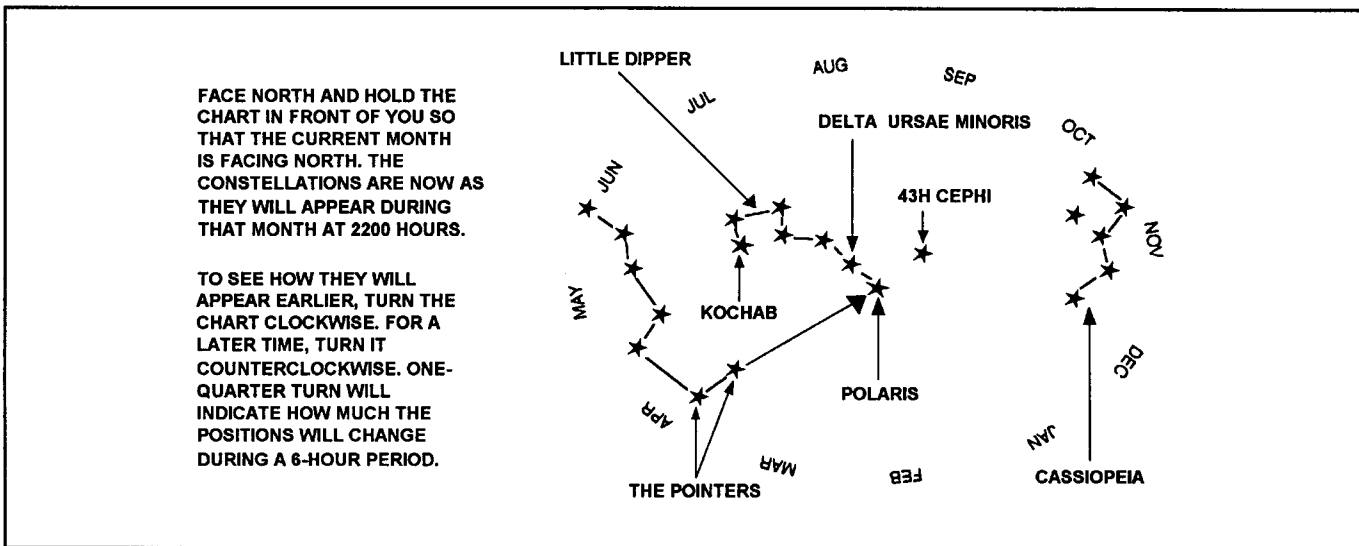

Figure 5-2. Star locations

b. For rough orientation of the aiming circle, the operator first sets the declination constant on the upper motion and centers the magnetic needle with the lower motion. Next, he determines his latitude, to the nearest degree, from a map and converts it to mils by multiplying by 18. He then sets this value on the elevation scale of the aiming circle. This should place his line of sight very close to Polaris. As instrument operators become more proficient at identifying Polaris through an aiming circle, they can eliminate this orientation procedure.

c. To establish the orienting line, the horizontal clockwise angle from Kochab to Polaris is measured. Then the true azimuth is extracted from the appropriate table and the true azimuth is converted to a grid azimuth. The steps for establishing direction by observing Polaris are as follows:

(1) Measure the angle.

(a) Set up and level the aiming circle over the selected point.

(b) Using the upper motion, set 0.0 mils on the azimuth scale.

(c) Place the vertical cross hair of the instrument on Kochab using the lower motion and the elevation micrometer knob.

(d) Turn the azimuth micrometer knob (upper motion) clockwise until the vertical cross hair is centered on Polaris. (The telescope may have to be elevated or depressed.)

(e) Read the value on the azimuth scale to the nearest mil. (This is the entry value used to enter Tables 5-2 through 5-5, pages 5-5 through 5-8.)

(f) Depress the telescope to ground level. Emplace an aiming post, at least 30 meters, along the line of sight of the vertical cross hair line. This will serve as the EOL, and the aiming circle becomes the OS.

(2) Extract the true azimuth to Polaris.

(a) Select Table 5-2, 5-3, 5-4, or 5-5, whichever pertains to the latitude closest to that of the instrument operator. If the instrument operator's location is exactly half-way between the latitudes listed on any two tables, either table may be used.

(b) Enter the appropriate table on the left side with the value from the upper motion of the aiming circle. Visually interpolate, if necessary, by using the value from (1)(e) above.

(c) Determine whether to intersect with Graph 1 (Kochab is below Polaris) or Graph 2 (Kochab is above Polaris). If in doubt, compare the vertical angle of the two stars.

(d) From the intersection of the measured angle from Kochab to Polaris on the appropriate graph, read the true azimuth to Polaris from the bottom of the table. Interpolate for odd-numbered values.

(3) Convert true azimuth to grid azimuth.

(a) Determine the grid convergence (the angle between true north and grid north) in mils, from the map sheet for the area of operations; or obtain it in the survey section.

(b) Convert the true azimuth to grid azimuth as shown in Figure 5-3.

(c) This computation results in the determination of the grid azimuth from the OS to the EOL.

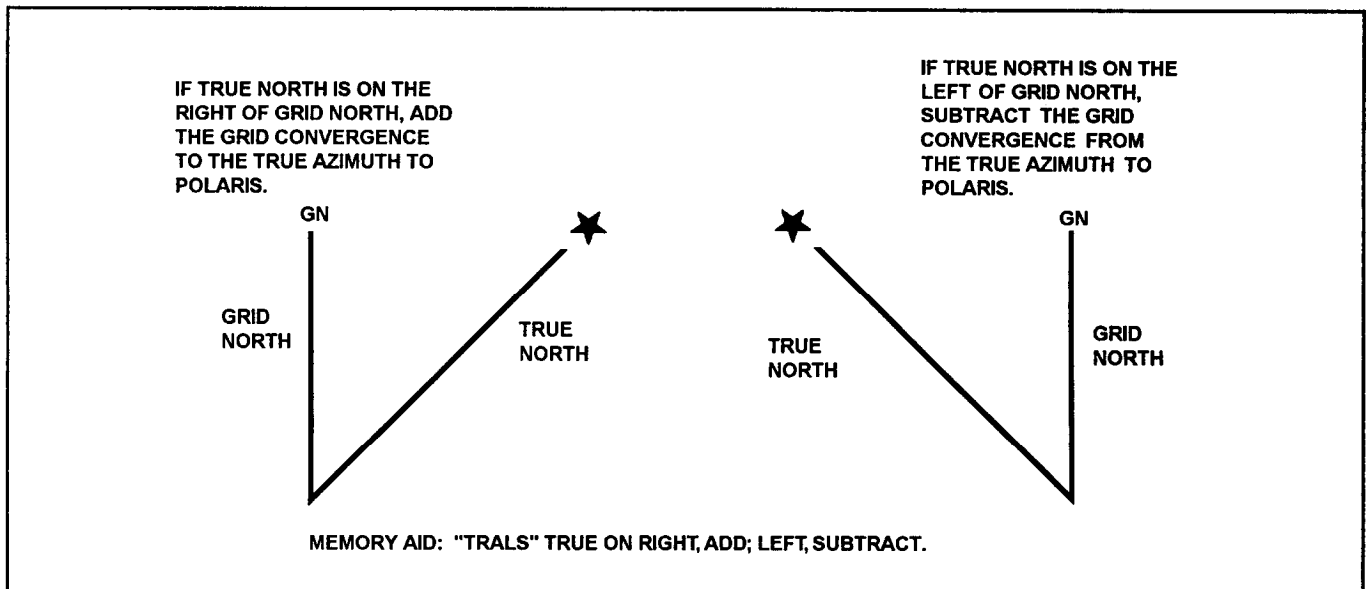

Figure 5-3. Application of grid convergence (Polaris-Kochab)

Table 5-2. Polaris-Kochab, determining true azimuth, 20° north latitude

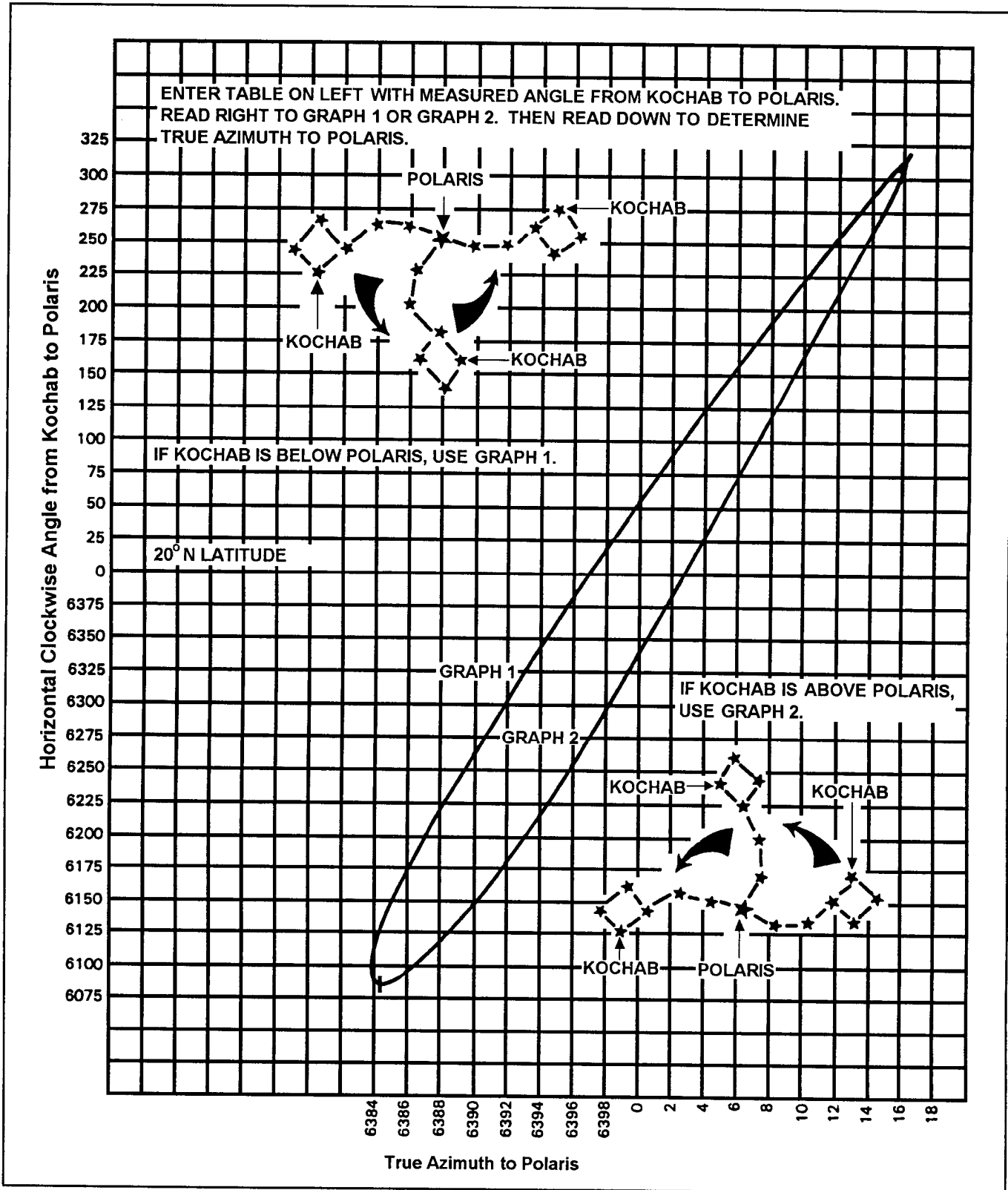

Table 5-3. Polaris-Kochab, determining true azimuth, 35° north latitude

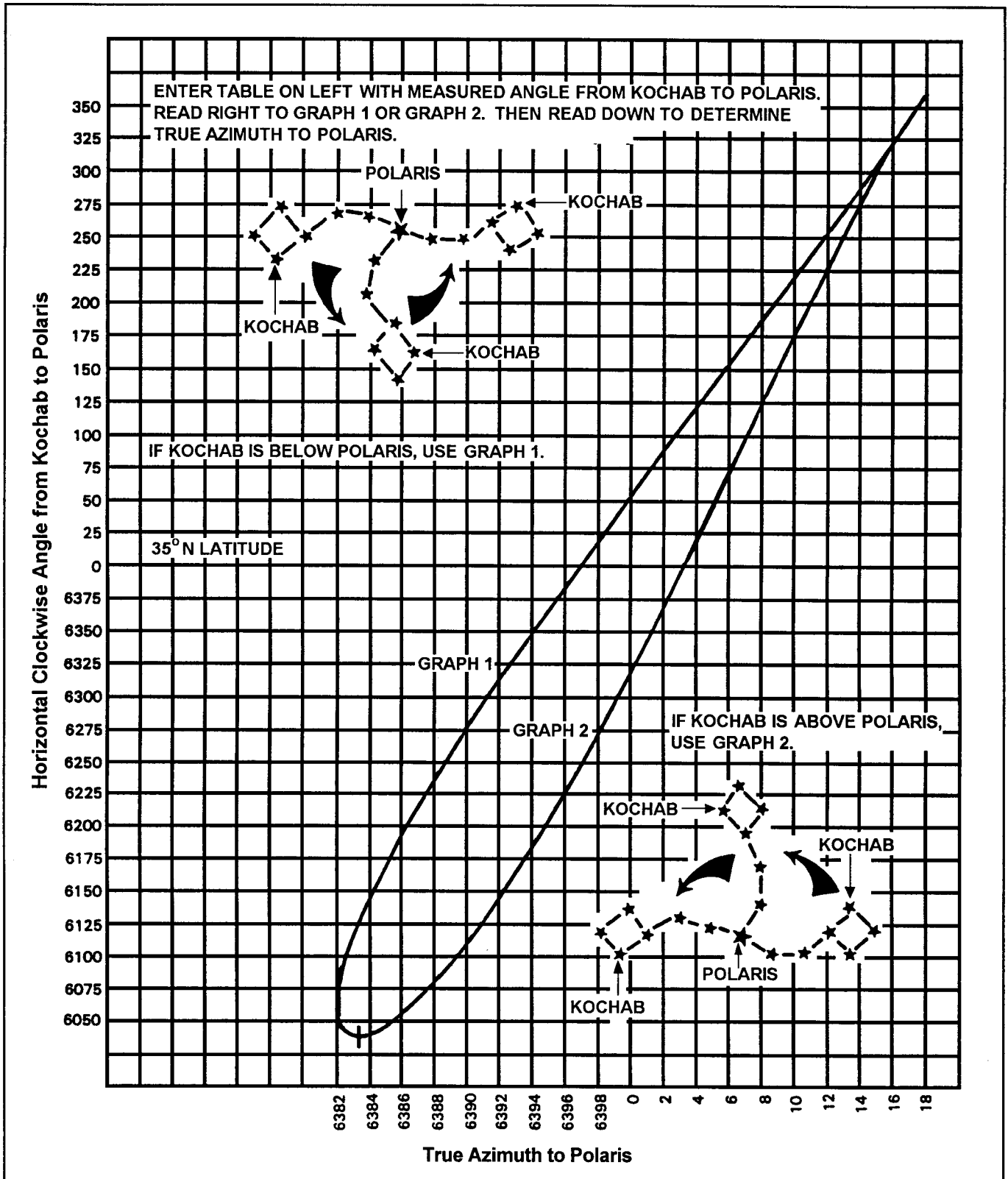
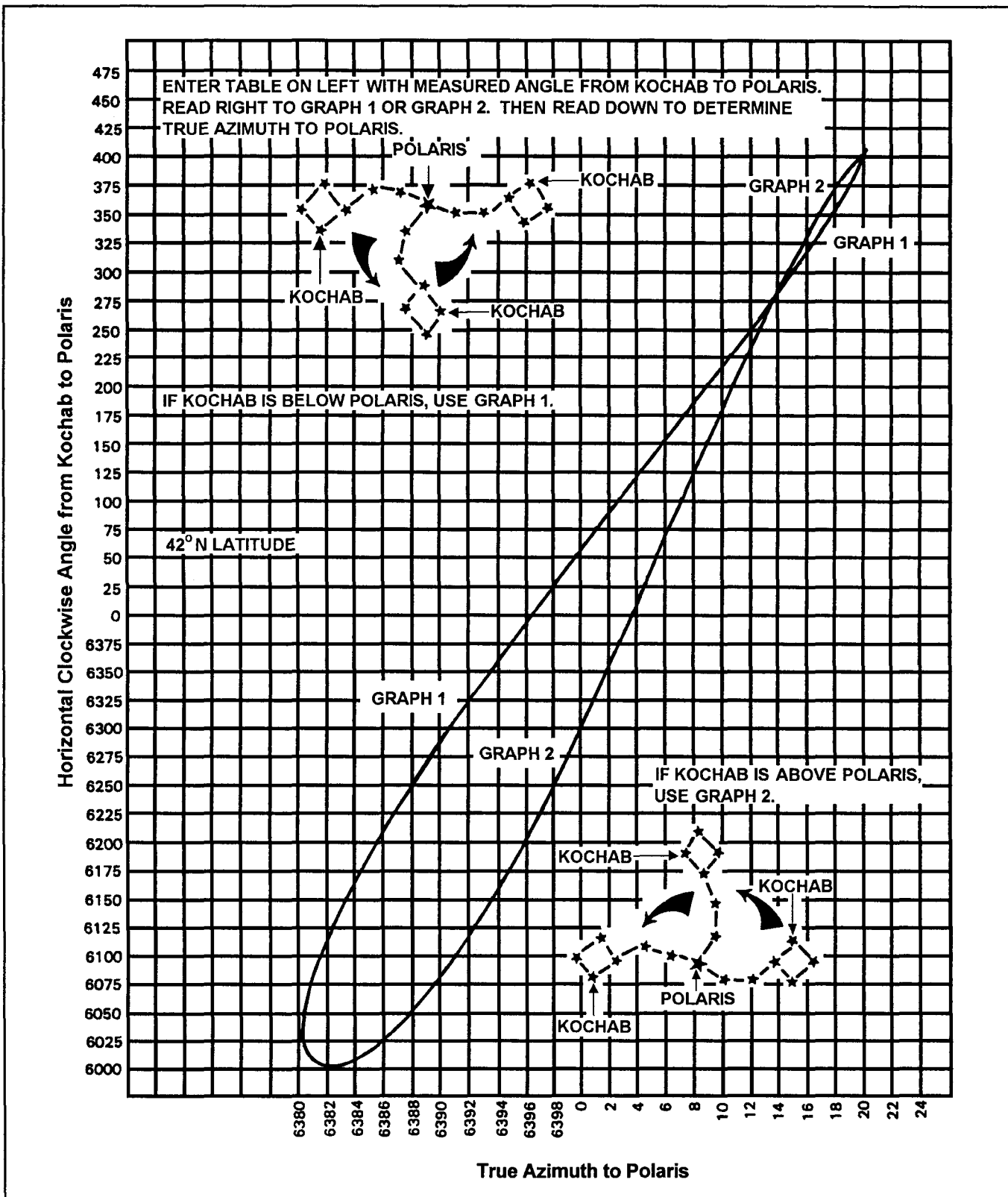

Table 5-4. Polaris-Kochab, determining true azimuth, 42° north latitude



5-5. POLARIS 2 METHOD

Polaris 2 is a hasty survey technique used to establish accurate direction. It is simple, fast and has the distinct advantage of requiring no radio or wire communications. The instrument operator, however, must be in the Northern hemisphere and must be able to locate the stars 43H Cephei, Polaris, and Delta Ursae Minoris (Figure 5-2, page 5-3).

Note: The Polaris II reticle will exceed its original service life in January 1996. In January 1996, the accuracy is 2.5 mils. The reticle can still be used, but the accuracy is degraded 0.1 mils each year after January 1996.

The procedures for establishing direction by the Polaris 2 method are as follows:

a. Locate the stars.

(1) Locate Polaris by using the procedures in paragraphs 5-4a(1) or 5-4b.

(2) To locate Delta Ursa Minoris and 43H Cephei, the instrument operator may have to reduce the light intensity in the telescope. The three brightest stars appearing in his field of view will be Polaris, 43H Cephei, and Delta Ursa Minoris. When Polaris is used as the vertex, the angle formed by Delta Ursa Minoris and 43H Cephei is about 1,800 mils (Figure 5-4). This relationship remains the same and rotates counterclockwise at about 150 each hour.

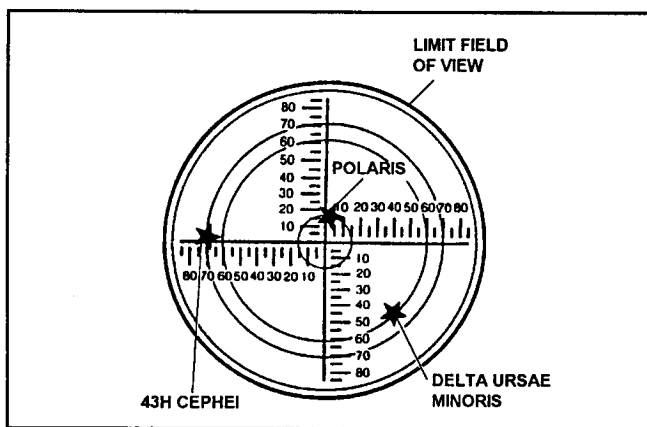

Figure 5-4. Polaris 2 with stars in tangent

b. Establish direction.

(1) Determine the grid convergence (the angle between true north and grid north) in mils, from the map sheet for the area of operation or from a survey section (Figure 5-5, page 5-10). Record this information.

(2) Set up and level the aiming circle over the selected point.

(3) Using the azimuth micrometer knob (**upper** motion), set the grid convergence on the azimuth scale (Figure 5-5).

(4) Using the elevation micrometer knob, set the predetermined elevation to Polaris (paragraph 5-4b) on the elevation scale.

(5) Using the orienting knob (lower motion), sight on Polaris. Ensure that the grid convergence remains correctly set on the azimuth scales.

(6) When Polaris is in the field of view, use the elevation knob and **lower** motion to place the stars on their respective circles as shown in Figure 5-4. There is no specific point on the circle on which the stars must be positioned. (The actual location of the stars on the circle depends on the time of year and the time of observation.)

(7) Emplace an aiming post, at least 30 meters from the aiming circle, at the desired location of the EOL.

(8) Using the elevation knob, lower the telescope. Use the **upper** motion to rotate the instrument clockwise until the vertical hairline is centered and at the lowest visible point on the aiming post.

(9) Read the azimuth to the nearest 0.5 mil directly from the azimuth scales.

(10) Using the procedures in paragraphs (3) through (9) above, determine a second azimuth to the EOL.

(11) The two azimuths determined to the EOL must agree within ± 2 mils. If the two azimuths agree within these limits, determine the mean grid azimuth. This is the grid azimuth to the EOL.

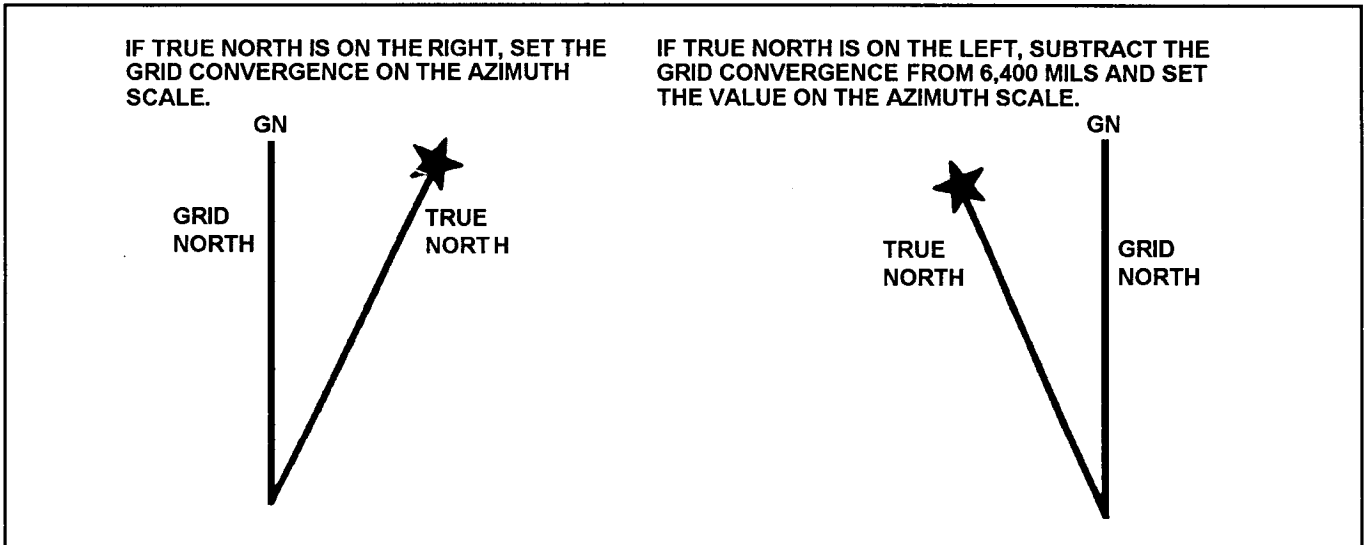

Figure 5-5. Convergence rules (Polaris 2)

5-6. DIRECTIONAL TRAVERSE

a. Directional traverse is another means of transferring azimuth from one point to another. It gives more accurate results than scaling an azimuth from a map or floating the needle of an aiming circle. However, it should be used only when conditions prohibit the use of the simultaneous observation, Polaris-Kochab, or the Polaris two-reticle

method. The only fieldwork required is to measure horizontal clockwise angles at each of the traverse stations (Figure 5-6). At the occupied station (Point A), these angles are always measured from the rear station clockwise to the forward station (Point B). At Point A, the azimuth to an azimuth mark (EOL) is known. The azimuth from A to B can be found by measuring the angle at A and adding that angle to the known azimuth from A to the azimuth mark.

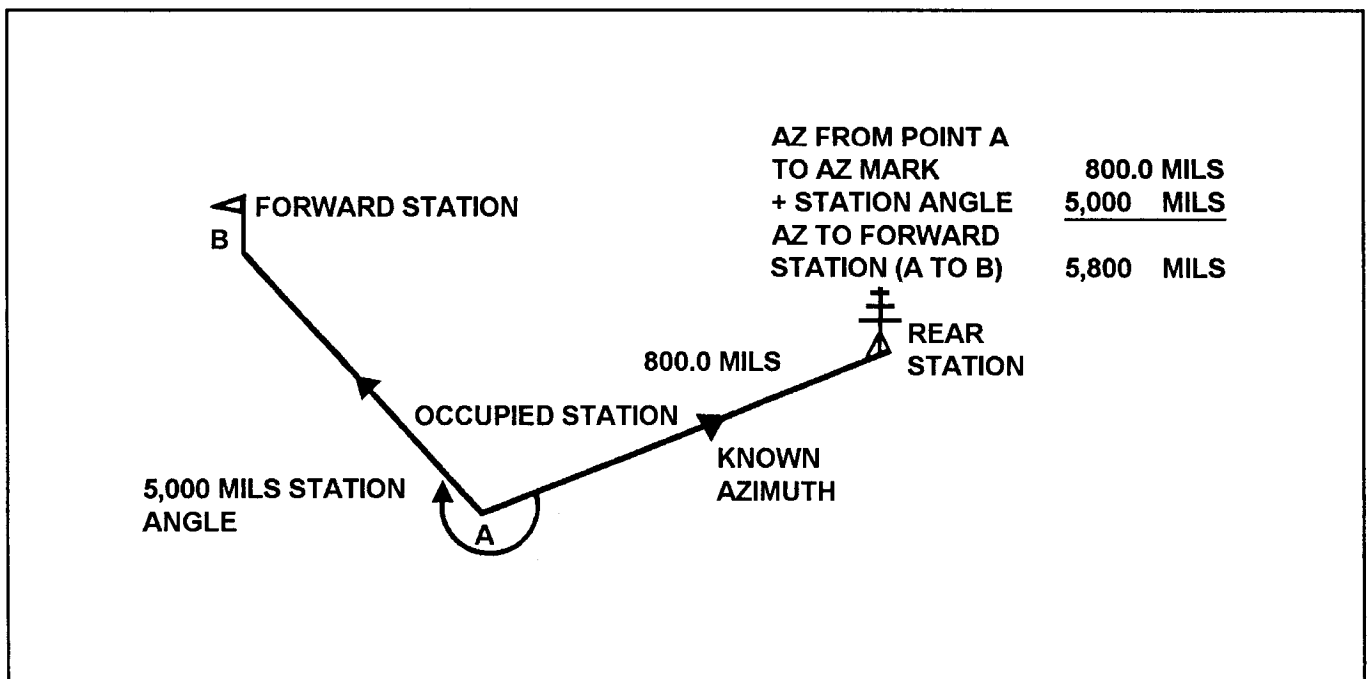

Figure 5-6. Fieldwork requirements for directional traverse

b. The number of stations in a directional traverse should be kept to a minimum to minimize the loss of accuracy. The only limiting factor on the length of a traverse leg is line of sight. The directional traverse should be planned so that the final forward station is the orienting station for the battery or platoon. The orienting line then becomes the back-azimuth of the last leg.

c. At battery or platoon level, angles are measured with the M2A2 aiming circle to the nearest 0.5 mil. Each angle that is measured degrades the accuracy of the initial azimuth by 0.5 mil. For example, a directional traverse requiring four angles to establish the azimuth to the EOL would have an accuracy of ±2 mils. The steps for conducting a directional traverse are as follows:

- (1) Set up and level the aiming circle over the occupied station.
- (2) With the **upper** motion, set 0.0 mils on the aiming circle.
- (3) With the **lower** motion, sight on the known reference point (rear station).
- (4) With the **upper** motion, measure the angle to the unknown point (forward station). Read this first reading to the nearest 0.5 mil, and record it.
- (5) With this reading still on the scales, sight again, using the **lower** motion, on the known reference point (rear station).
- (6) With the **upper** motion, again measure the angle to the forward station. Read this second reading to the nearest 0.5 mil, and record it.
- (7) Divide the second reading by 2 to determine the mean angle. If the second reading is smaller than the first reading, 6400 mils must be added to the second reading before dividing by two. Express the quotient to the nearest 0.1 mil. The mean angle must agree with the first reading within 0.5 mil. If it does not, the angle must be remeasured. The mean angle is the angle used in the computation of the directional traverse and is referred to as the station angle.

EXAMPLE 1

1st reading= 1036.0
 2d reading= 2072.5
 $2072.5 \div 2 = 1036.2$
 The mean angle is valid because it agrees with the 1st reading within 0.5 mil.

EXAMPLE 2

1st reading = 3966.0
 2d reading = 1533.5
 $1533.5 + 6400 = 7933.5$
 $7933.5 \div 2 = 3966.8$
 The mean angle is not valid because it does not agree with the first reading within 0.5 mil. The angle must be remeasured.

d. A directional traverse is shown in Figure 5-7, page 5-12, and the following example.

EXAMPLE

The known data are as follows:

Azimuth from A to the azimuth mark = 0805.0
 The mean station angles measured were as follows:

| | |
|-----------|--------|
| Station A | 4997.5 |
| TS-1 | 2248.2 |
| TS-2 | 5168.8 |

The method of determining the azimuth from B to TS-2 is as follows:

| | |
|-------------------------------------|-----------------|
| Known azimuth A to azimuth mark is: | 0805.0 |
| Plus station angle at A: | <u>+ 4997.5</u> |
| AZ station A to TS-1: | 5802.5 |

(To determine back azimuth, the next step is always required.)

| | |
|----------------------------|-----------------|
| ±3,200 mils | <u>- 3200.0</u> |
| AZ TS-1 to station A | 2602.5 |
| Plus station angle at TS | <u>+ 2248.2</u> |
| AZ TS-1 to TS-2 | 4850.7 |
| 3,200 mils | <u>- 3200.0</u> |
| AZ TS-2 to TS-1 | 1650.7 |
| Plus station angle at TS-2 | <u>+ 5168.8</u> |

(If the sum of an azimuth 6819.5 and a station angle exceeds 6,400 mils, then 6,400 mils must be subtracted).

| | |
|----------------------|-----------------|
| AZ TS-2 to station B | 0419.5 |
| 3,200 mils | <u>+ 3200.0</u> |
| AZ B to TS-2 | 3619.5 |
| AZ from OS A to EOL | 3619.5 |

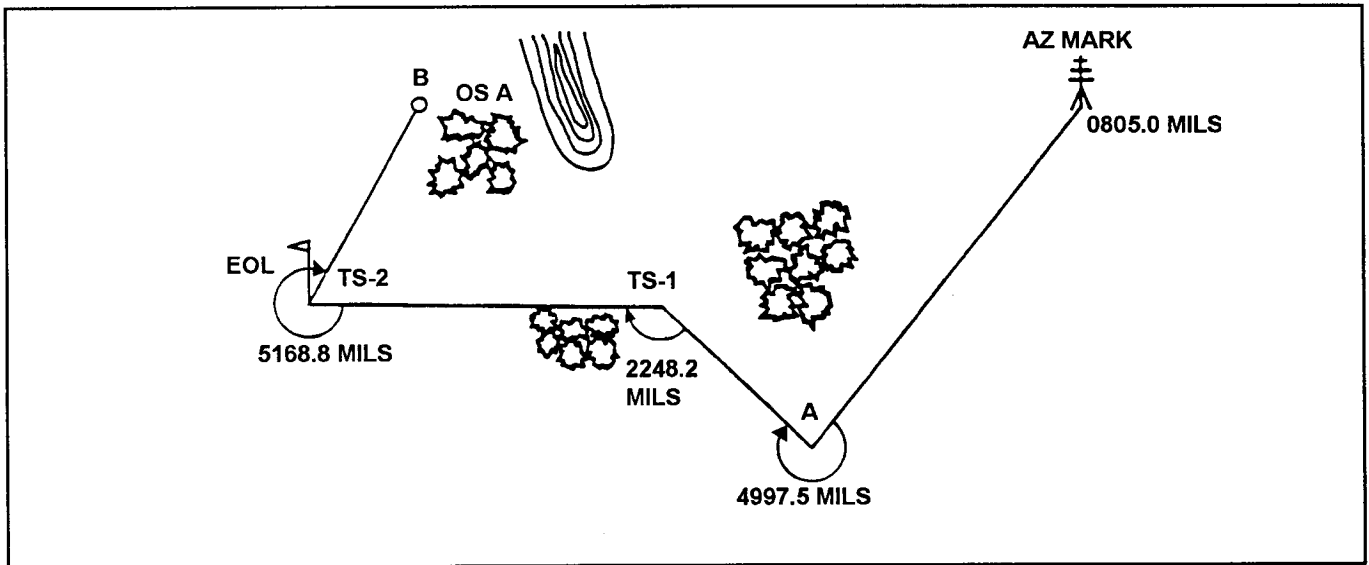

Figure 5-7. Example of a directional traverse

Section III LOCATION

5-7. METHODS OF LOCATION

Whenever the tactical situation permits, the firing units position should be surveyed before the unit arrives. Information provided by the survey section will include coordinates and height of the orienting station, and the grid azimuth from the orienting station to the EOL. When survey control is not available, the desired location may be determined through the use of graphic resection or graphic traverse.

Note: If automated fire direction capability is not available, battery center, in addition to the orienting station, should be surveyed.

5-8. GRAPHIC RESECTION

a. Graphic resection is a quick method of determining a position based on the known locations of certain visible points. The equipment needed to perform a graphic resection includes an aiming circle, map sheet, grid sheet, overlay paper and standard FDC plotting equipment. Graphic resection may be done in one of two ways, both of which are discussed below.

(1) No azimuth control available.

(a) Select a location from which three distant points, which appear on a map, are visible. These points should be well defined vertical features, such as towers, trig markers or church steeples.

(b) With the aiming circle, measure the three clockwise angles between these points. For each angle, use the standard measuring procedure outlined in paragraph 5-6c. (See Figure 5-8.)

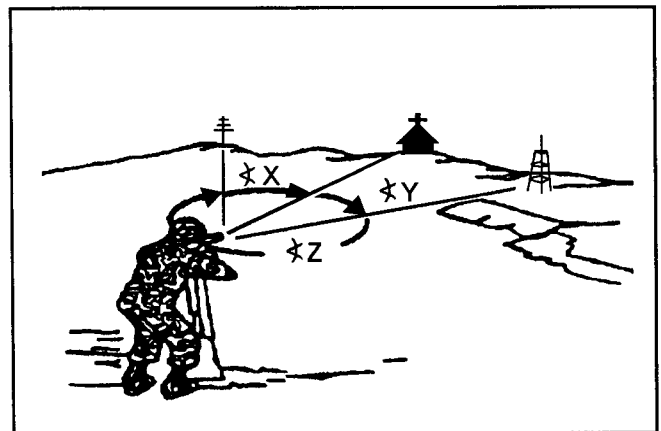

Figure 5-8. Measuring angles

(c) Check that the sum of the three angles equals 6400 mils, ± 1.5 mils. This verifies that each angle is accurate to 0.5 mil and that the three angles together encompass the entire horizon.

(d) Scale the coordinates of the three known points off a map (to eight digits), and transfer the plots onto a grid sheet (standard 1:25,000 firing chart). A trig list of known points may also be used.

(e) Place a pin at a random point near the center of the overlay (tracing) paper. Using target grid a mil graduated protractor, or a range-deflection protractor (RDP), draw a line from the pinhole to any corner of the paper and label it as the ray to the first of the three points. With the target grid, protractor, or RDP, measure clockwise the number of mils corresponding to the angle between the first and second known points. Draw and label the second ray to represent the second known point. Measure clockwise the number of mils corresponding to the angle between the second and third known points. Draw and label a third ray representing the third known point. You will note that the third angle (between the third and first known point) is now already constructed on the overlay paper. It should be measured to ensure that plotting errors have not occurred. (See Figure 5-9.)

(f) Place the overlay paper on the grid sheet and position it so that the three rays pass directly through their respective points. The position of the pin now represents the location of the aiming circle on the grid sheet. (See Figure 5-10.)

(2) Azimuth control available. In some cases, the aiming circle is positioned over the orienting station with a known orienting line established. If only two known points are visible, the resection may also be performed, by a somewhat different procedure.

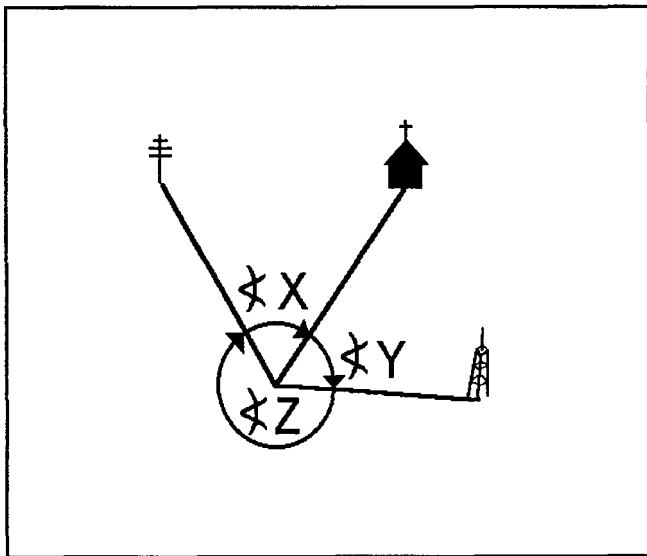

Figure 5-9. Transferring angles to paper

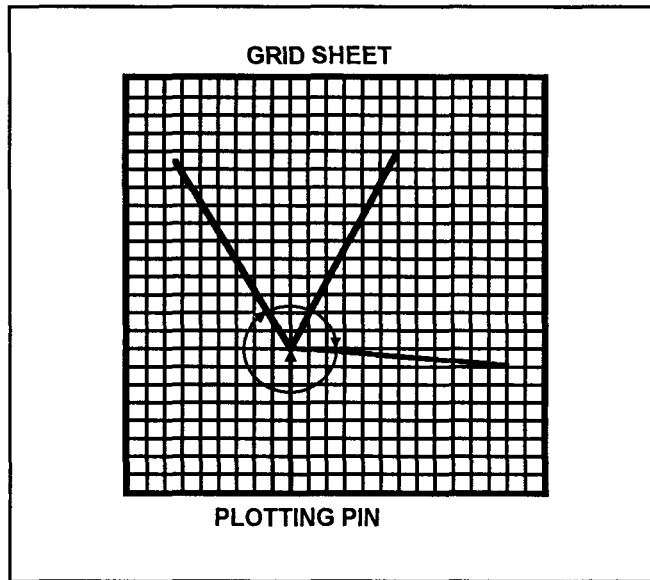

Figure 5-10. Determining position

(a) Measure the clockwise angles to each of the two known points from the EOL.

(b) Determine the azimuth to each known point by adding the azimuth of the orienting line to the appropriate angle measured in (a) above.

(c) Convert each of these azimuths to back-azimuths by applying 3,200 mils.

(d) Transfer the coordinates of the known points from the map to the grid sheet.

(e) Using the RDP, plot the back azimuths from the two known points on the grid sheet. The point of intersection of the two rays is the position of the aiming circle.

b. Regardless of which method of graphic resection is used, the end result is always the location of the aiming circle. If the resection was not performed from the orienting station, the coordinates may be determined by graphic traverse, hasty traverse, or estimation based on the results of the resection. The resection should be checked against the map to preclude a gross error.

5-9. GRAPHIC TRAVERSE

Graphic traverse is a means of transferring direction and location control from one point to another by uses of angle and distance measurements. It may be used to provide direction and coordinates to a battery position. It is also ideal for transferring survey control to an offset registration position or to a roving gun from a surveyed battery or platoon position. The technique is similar to that used in directional

traverse. However, the personnel performing the traverse must measure not only the horizontal angle at each occupied station but also the distance to each forward station. The data needed to begin a graphic traverse include the coordinates of a known point and the direction to an azimuth mark. The only equipment required is an aiming circle, aiming posts (for the marking of stations), and FDC equipment. The procedures for conducting a graphic traverse are as follows:

a. Begin the traverse at the known survey control point (SCP). Follow the procedures for directional traverse to measure the station angle from the azimuth mark (rear station) to the first forward station. Compute the azimuth of the first leg of the traverse.

b. Measure the distance from the occupied station to the forward station. The procedures for making this measurement are discussed in paragraph 5-10.

c. Plot the coordinates of the SCP (starting point) on the FDC grid sheet. Using a target grid, a protractor, or an RDP, establish an azimuth index that corresponds to the computed azimuth from the starting point to the forward point; and draw a line representing the azimuth of the first traverse leg. Scale this azimuth line as close as possible. With the plotting (boxwood) scale, measure the distance of the traverse leg; and mark the forward station with a plotting pin.

d. Continue the fieldwork for the traverse as described above. Forward stations are successively established as needed, station angles are measured accordingly, and the azimuth of each leg computed as in directional traverse. The distance of each leg is plotted in the same manner as above. The traverse will appear on the grid sheet as a series of successive polar plots.

e. The traverse is planned so that the final forward station is the orienting station or other needed position. The EOL is the final occupied station in the traverse. The orienting line is the back-azimuth of the last traverse leg.

5-10. DISTANCE MEASURING

When graphic traverse is used to transfer survey control, the distance of each traverse leg must be measured. Since this distance is plotted on a grid sheet, it must be the horizontal distance along the traverse leg, not the slope distance obtained by measuring along the contour of the earth. In simplified survey operations, this horizontal distance can be easily measured in one of three ways (subtense, pacing, and using premeasured communications wire).

a Subtense. The subtense method is the fastest of three distance-measuring procedures. It yields accuracy equivalent to that obtained with a premeasured piece of wire. An advantage is that a horizontal distance is obtained indirectly; that is, the distance is computed, rather than measured. This allows subtense to be used over terrain where obstacles, such as streams, ravines, or steep slopes may prohibit pacing or the use of wire.

(1) The subtense method uses precise values with a trigonometric solution (listed in tables 5-6 through 5-8, pages 5-16 through 5-21). Subtense is based on a principle of visual perspective—the farther away an object is the smaller it appears.

(2) There are two procedures involved in subtense measurement:

- Establishing a base of known length.
- Measuring the angle of that base with the use of the aiming circle.

(3) The subtense base may be any desired length. However, if a 60 meter base, a 2 meter bar, or the length of an M16A1 or M16A2 rifle is used, precomputed subtense tables are available. The M16 or 2 meter bar must be held perpendicular to the line of sight by a soldier facing the aiming circle. The instrument operator sights on one end of the M 16 or 2 meter bar and measures the horizontal clockwise angle to the other end of the rifle or bar. He does this twice and means the angles. He then enters the appropriate subtense table with the mean angle and extracts the distance. Accurate distances can be obtained with the M16 out to approximately 150 meters, with the 2 meter bar out to 250 meters, and with the 60 meter base out to 1,000 meters. If a base of another length is desired, a distance can be computed by using the following formula:

$$\text{Distance} = \frac{1/2 \text{ BASE (in meters)}}{\text{TAN (1/2 angle) (in mils)}}$$

Note: During advance party operations at night, subtense may be obtained by attaching two lights on the pantel marker. The lights are separated by the length of an M 16 rifle. The aiming circle operator measures the vertical distance from one light to the other using the elevation micrometer knob. He performs this twice and determines the mean angle.

b. Pacing. A soldier who has measured his pace should be able to pace 100 meters to an accuracy of ± 1 meter over level ground. However, the paced distance follows the contour of the earth. Therefore, in sloping or rough terrain,

the determination of a horizontal distance becomes more difficult. A soldier can try to adjust his pace length to the degree of slope he is pacing, but his accuracy is decreased. Pacing should be used only over relatively flat terrain or when no other method is available.

c. Use of Premeasured Length of Communications Wire. A premeasured length of communications wire (WD-1) also may be used as a means of distance measurement. This method is substantially more accurate than pacing, but requires two soldiers to hold the ends of the wire. The wire may be of any length, although it is recommended that a length of 60 meters be used. The wire should be marked with tape at every meter increment and with color-coded tape at every 10-meter increment.

(1) The two soldiers holding the wire begin at the occupied station and measure in a straight line to the forward station. As the soldiers move along the traverse leg, they should count the number of whole wire lengths measured. By use of the meter increments marked on the wire, they measure the last partial length of wire. The distance of the leg can be determined by multiplying the number of whole wire lengths by 60 (the length of the wire) and adding the partial length.

(2) The premeasured wire method is fast and meets accuracy requirements for hasty survey techniques. However, the wire must be held horizontally to obtain a horizontal distance. That means that in rough terrain, when one end of the wire is much higher or lower than the other, it will be extremely difficult to measure long horizontal distances. In such cases, a portion of the 60-meter wire can be held horizontally and the entire distance measured using these shorter lengths.

EXAMPLE

You are using a 2-meter (m) subtense bar and measure an angle of 10.5 mils (ρ). You determine the horizontal distance by use of the formula:

$$\text{Distance} = \frac{1/2 \text{ base}}{\tan 1/2(\text{angle})} = \frac{1}{\tan (5.25)} = \frac{1}{0.005154} = 194 \text{ meters}$$

Note: You must convert mils to degrees by dividing 17.778 into the angle determined. To determine the tangent (tan) of an angle, you will need a calculator or TM 6-230.

Table 5-6. Subtense using a 2 meter base (bar)

| ANGLE | DISTANCE | ANGLE | DISTANCE | ANGLE | DISTANCE |
|-------|----------|-------|----------|-------|----------|
| 6 | 340 | 21.8 | 93 | 37.5 | 54 |
| 6.2 | 329 | 22 | 93 | 37.8 | 54 |
| 6.5 | 313 | 22.2 | 92 | 38 | 54 |
| 6.8 | 300 | 22.5 | 91 | 38.2 | 53 |
| 7 | 291 | 22.8 | 89 | 38.5 | 53 |
| 7.2 | 283 | 23 | 89 | 38.8 | 52 |
| 7.5 | 272 | 23.2 | 88 | 39 | 52 |
| 7.8 | 261 | 23.5 | 87 | 39.2 | 52 |
| 8 | 255 | 23.8 | 86 | 39.5 | 52 |
| 8.2 | 248 | 24 | 85 | 39.8 | 51 |
| 8.5 | 240 | 24.2 | 84 | 40 | 51 |
| 8.8 | 231 | 24.5 | 83 | 40.2 | 51 |
| 9 | 226 | 24.8 | 82 | 40.5 | 50 |
| 9.2 | 221 | 25 | 81 | 40.8 | 50 |
| 9.5 | 214 | 25.2 | 81 | 41 | 50 |
| 9.8 | 208 | 25.5 | 80 | 41.2 | 49 |
| 10 | 204 | 25.8 | 79 | 41.5 | 49 |
| 10.2 | 200 | 26 | 78 | 41.8 | 49 |
| 10.5 | 194 | 26.2 | 78 | 42 | 48 |
| 10.8 | 189 | 26.5 | 77 | 42.2 | 48 |
| 11 | 185 | 26.8 | 76 | 42.5 | 48 |
| 11.2 | 182 | 27 | 75 | 42.8 | 48 |
| 11.5 | 177 | 27.2 | 75 | 43 | 47 |
| 11.8 | 173 | 27.5 | 74 | | |
| 12 | 170 | 27.8 | 73 | | |
| 12.2 | 167 | 28 | 73 | | |
| 12.5 | 163 | 28.2 | 72 | | |
| 12.8 | 159 | 28.5 | 71 | | |
| 13 | 157 | 28.8 | 71 | | |
| 13.2 | 154 | 29 | 70 | | |
| 13.5 | 151 | 29.2 | 70 | | |
| 13.8 | 148 | 29.5 | 69 | | |
| 14 | 146 | 29.8 | 68 | | |
| 14.2 | 143 | 30 | 68 | | |
| 14.5 | 140 | 30.2 | 67 | | |
| 14.8 | 138 | 30.5 | 67 | | |
| 15 | 136 | 30.8 | 66 | | |
| 15.2 | 134 | 31 | 66 | | |
| 15.5 | 131 | 31.2 | 65 | | |
| 15.8 | 129 | 31.5 | 65 | | |
| 16 | 127 | 31.8 | 64 | | |
| 16.2 | 126 | 32 | 64 | | |
| 16.5 | 123 | 32.2 | 63 | | |
| 16.8 | 121 | 32.5 | 63 | | |
| 17 | 120 | 32.8 | 62 | | |
| 17.2 | 118 | 33 | 62 | | |
| 17.5 | 116 | 33.2 | 61 | | |
| 17.8 | 114 | 33.5 | 61 | | |
| 18 | 113 | 33.8 | 60 | | |
| 18.2 | 112 | 34 | 60 | | |
| 18.5 | 110 | 34.2 | 60 | | |
| 18.8 | 108 | 34.5 | 59 | | |
| 19 | 107 | 34.8 | 59 | | |
| 19.2 | 106 | 35 | 58 | | |
| 19.5 | 104 | 35.2 | 58 | | |
| 19.8 | 103 | 35.5 | 57 | | |
| 20 | 102 | 35.8 | 57 | | |
| 20.2 | 101 | 36 | 57 | | |
| 20.5 | 99 | 36.2 | 56 | | |
| 20.8 | 98 | 36.5 | 56 | | |
| 21 | 97 | 36.8 | 55 | | |
| 21.2 | 96 | 37 | 55 | | |
| 21.5 | 95 | 37.2 | 55 | | |

Table 5-7. Subtense using an M16A1/A2 as base

| ANGLE | DISTANCE | | ANGLE | DISTANCE | | ANGLE | DISTANCE | | ANGLE | DISTANCE | |
|-------|----------|-------|-------|----------|-------|-------|----------|-------|-------|----------|-------|
| | M16A1 | M16A2 | | M16A1 | M16A2 | | M16A1 | M16A2 | | M16A1 | M16A2 |
| 6 | 167 | 171 | 16.2 | 62 | 63 | 26.5 | 38 | 39 | 36.8 | 27 | 28 |
| 6.2 | 162 | 165 | 16.5 | 61 | 62 | 26.8 | 37 | 38 | 37 | 27 | 28 |
| 6.5 | 154 | 158 | 16.8 | 60 | 61 | 27 | 37 | 38 | 37.2 | 27 | 28 |
| 6.8 | 148 | 151 | 17 | 59 | 60 | 27.2 | 37 | 38 | 37.5 | 27 | 27 |
| 7 | 143 | 146 | 17.2 | 58 | 60 | 27.5 | 37 | 37 | 37.8 | 27 | 27 |
| 7.2 | 139 | 142 | 17.5 | 57 | 59 | 27.8 | 36 | 37 | 38 | 26 | 27 |
| 7.5 | 134 | 137 | 17.8 | 56 | 58 | 28 | 36 | 37 | 38.2 | 26 | 27 |
| 7.8 | 129 | 131 | 18 | 56 | 57 | 28.2 | 36 | 36 | 38.5 | 26 | 27 |
| 8 | 126 | 128 | 18.2 | 55 | 56 | 28.5 | 35 | 36 | 38.8 | 26 | 26 |
| 8.2 | 122 | 125 | 18.5 | 54 | 55 | 28.8 | 35 | 36 | 39 | 26 | 26 |
| 8.5 | 118 | 121 | 18.8 | 53 | 55 | 29 | 35 | 35 | 39.2 | 26 | 26 |
| 8.8 | 114 | 116 | 19 | 53 | 54 | 29.2 | 34 | 35 | 39.5 | 25 | 26 |
| 9 | 112 | 114 | 19.2 | 52 | 53 | 29.5 | 34 | 35 | 39.8 | 25 | 26 |
| 9.2 | 109 | 111 | 19.5 | 51 | 53 | 29.8 | 34 | 34 | 40 | 25 | 26 |
| 9.5 | 106 | 108 | 19.8 | 51 | 52 | 30 | 33 | 34 | | | |
| 9.8 | 102 | 105 | 20 | 50 | 51 | 30.2 | 33 | 34 | | | |
| 10 | 100 | 102 | 20.2 | 50 | 51 | 30.5 | 33 | 34 | | | |
| 10.2 | 98 | 100 | 20.5 | 49 | 50 | 30.8 | 33 | 33 | | | |
| 10.5 | 96 | 98 | 20.8 | 48 | 49 | 31 | 32 | 33 | | | |
| 10.8 | 93 | 95 | 21 | 48 | 49 | 31.2 | 32 | 33 | | | |
| 11 | 91 | 93 | 21.2 | 47 | 48 | 31.5 | 32 | 33 | | | |
| 11.2 | 90 | 91 | 21.5 | 47 | 48 | 31.8 | 32 | 32 | | | |
| 11.5 | 87 | 89 | 21.8 | 46 | 47 | 32 | 31 | 32 | | | |
| 11.8 | 85 | 87 | 22 | 46 | 47 | 32.2 | 31 | 32 | | | |
| 12 | 84 | 85 | 22.2 | 45 | 46 | 32.5 | 31 | 32 | | | |
| 12.2 | 82 | 84 | 22.5 | 45 | 46 | 32.8 | 31 | 31 | | | |
| 12.5 | 80 | 82 | 22.8 | 44 | 45 | 33 | 30 | 31 | | | |
| 12.8 | 78 | 80 | 23 | 44 | 45 | 33.2 | 30 | 31 | | | |
| 13 | 77 | 79 | 23.2 | 43 | 44 | 33.5 | 30 | 31 | | | |
| 13.2 | 76 | 78 | 23.5 | 43 | 44 | 33.8 | 30 | 30 | | | |
| 13.5 | 74 | 76 | 23.8 | 42 | 43 | 34 | 30 | 30 | | | |
| 13.8 | 73 | 74 | 24 | 42 | 43 | 34.2 | 29 | 30 | | | |
| 14 | 72 | 73 | 24.2 | 41 | 42 | 34.5 | 29 | 30 | | | |
| 14.2 | 71 | 72 | 24.5 | 41 | 42 | 34.8 | 29 | 29 | | | |
| 14.5 | 69 | 71 | 24.8 | 40 | 41 | 35 | 29 | 29 | | | |
| 14.8 | 68 | 69 | 25 | 40 | 41 | 35.2 | 29 | 29 | | | |
| 15 | 67 | 68 | 25.2 | 40 | 41 | 35.5 | 28 | 29 | | | |
| 15.2 | 66 | 67 | 25.5 | 39 | 40 | 35.8 | 28 | 29 | | | |
| 15.5 | 65 | 66 | 25.8 | 39 | 40 | 36 | 28 | 28 | | | |
| 15.8 | 64 | 65 | 26 | 39 | 39 | 36.2 | 28 | 28 | | | |
| 16 | 63 | 64 | 26.2 | 38 | 39 | 36.5 | 28 | 28 | | | |

Note: Measure M16 rifles from the top of the butt to the end of the flash suppressor.

Table 5-8. Subtense using a 60 meter base

| ANGLE | DISTANCE | ANGLE | DISTANCE | ANGLE | DISTANCE | ANGLE | DISTANCE |
|-------|----------|-------|----------|-------|----------|-------|----------|
| 60 | 1018 | 70.8 | 863 | 81.5 | 749 | 92.2 | 662 |
| 60.2 | 1015 | 71 | 860 | 81.8 | 747 | 92.5 | 660 |
| 60.5 | 1010 | 71.2 | 858 | 82 | 745 | 92.8 | 658 |
| 60.8 | 1005 | 71.5 | 854 | 82.2 | 743 | 93 | 657 |
| 61 | 1002 | 71.8 | 851 | 82.5 | 740 | 93.2 | 655 |
| 61.2 | 998 | 72 | 848 | 82.8 | 738 | 93.5 | 653 |
| 61.5 | 993 | 72.2 | 846 | 83 | 736 | 93.8 | 651 |
| 61.8 | 989 | 72.5 | 843 | 83.2 | 734 | 94 | 650 |
| 62 | 985 | 72.8 | 839 | 83.5 | 732 | 94.2 | 648 |
| 62.2 | 982 | 73 | 837 | 83.8 | 729 | 94.5 | 646 |
| 62.5 | 978 | 73.2 | 835 | 84 | 727 | 94.8 | 644 |
| 62.8 | 973 | 73.5 | 831 | 84.2 | 725 | 95 | 643 |
| 63 | 970 | 73.8 | 828 | 84.5 | 723 | 95.2 | 642 |
| 63.2 | 967 | 74 | 826 | 84.8 | 720 | 95.5 | 639 |
| 63.5 | 962 | 74.2 | 823 | 85 | 719 | 95.8 | 637 |
| 63.8 | 958 | 74.5 | 820 | 85.2 | 717 | 96 | 636 |
| 64 | 955 | 74.8 | 817 | 85.5 | 714 | 96.2 | 635 |
| 64.2 | 952 | 75 | 815 | 85.8 | 712 | 96.5 | 633 |
| 64.5 | 947 | 75.2 | 812 | 86 | 710 | 96.8 | 631 |
| 64.8 | 943 | 75.5 | 809 | 86.2 | 709 | 97 | 630 |
| 65 | 940 | 75.8 | 806 | 86.5 | 706 | 97.2 | 628 |
| 65.2 | 937 | 76 | 804 | 86.8 | 704 | 97.5 | 626 |
| 65.5 | 933 | 76.2 | 802 | 87 | 702 | 97.8 | 624 |
| 65.8 | 928 | 76.5 | 799 | 87.2 | 700 | 98 | 623 |
| 66 | 926 | 76.8 | 795 | 87.5 | 698 | 98.2 | 622 |
| 66.2 | 923 | 77 | 793 | 87.8 | 696 | 98.5 | 620 |
| 66.5 | 919 | 77.2 | 791 | 88 | 694 | 98.8 | 618 |
| 66.8 | 915 | 77.5 | 788 | 88.2 | 692 | 99 | 617 |
| 67 | 912 | 77.8 | 785 | 88.5 | 690 | 99.2 | 616 |
| 67.2 | 909 | 78 | 783 | 88.8 | 688 | 99.5 | 614 |
| 67.5 | 905 | 78.2 | 781 | 89 | 686 | 99.8 | 612 |
| 67.8 | 901 | 78.5 | 778 | 89.2 | 685 | 100 | 611 |
| 68 | 898 | 78.8 | 775 | 89.5 | 682 | 100.2 | 609 |
| 68.2 | 896 | 79 | 773 | 89.8 | 680 | 100.5 | 608 |
| 68.5 | 892 | 79.2 | 771 | 90 | 679 | 100.8 | 606 |
| 68.8 | 888 | 79.5 | 768 | 90.2 | 677 | 101 | 605 |
| 69 | 885 | 79.8 | 765 | 90.5 | 675 | 101.2 | 603 |
| 69.2 | 883 | 80 | 764 | 90.8 | 673 | 101.5 | 602 |
| 69.5 | 879 | 80.2 | 762 | 91 | 671 | 101.8 | 600 |
| 69.8 | 875 | 80.5 | 759 | 91.2 | 670 | 102 | 599 |
| 70 | 873 | 80.8 | 756 | 91.5 | 667 | 102.2 | 597 |
| 70.2 | 870 | 81 | 754 | 91.8 | 665 | 102.5 | 596 |
| 70.5 | 867 | 81.2 | 752 | 92 | 664 | 102.8 | 594 |

Table 5-8. Subtense using a 60 meter base (continued)

| ANGLE | DISTANCE | ANGLE | DISTANCE | ANGLE | DISTANCE | ANGLE | DISTANCE |
|-------|----------|-------|----------|-------|----------|-------|----------|
| 103 | 593 | 113.8 | 536 | 124.5 | 490 | 135.2 | 451 |
| 103.2 | 592 | 114 | 536 | 124.8 | 489 | 135.5 | 450 |
| 103.5 | 590 | 114.2 | 535 | 125 | 488 | 135.8 | 449 |
| 103.8 | 588 | 114.5 | 533 | 125.2 | 488 | 136 | 449 |
| 104 | 587 | 114.8 | 532 | 125.5 | 486 | 136.2 | 448 |
| 104.2 | 586 | 115 | 531 | 125.8 | 485 | 136.5 | 447 |
| 104.5 | 584 | 115.2 | 530 | 126 | 484 | 136.8 | 446 |
| 104.8 | 583 | 115.5 | 529 | 126.2 | 484 | 137 | 445 |
| 105 | 582 | 115.8 | 527 | 126.5 | 483 | 137.2 | 445 |
| 105.2 | 580 | 116 | 526 | 126.8 | 481 | 137.5 | 444 |
| 105.5 | 579 | 116.2 | 525 | 127 | 481 | 137.8 | 443 |
| 105.8 | 577 | 116.5 | 524 | 127.2 | 480 | 138 | 442 |
| 106 | 576 | 116.8 | 523 | 127.5 | 479 | 138.2 | 442 |
| 106.2 | 575 | 117 | 522 | 127.8 | 478 | 138.5 | 441 |
| 106.5 | 573 | 117.2 | 521 | 128 | 477 | 138.8 | 440 |
| 106.8 | 572 | 117.5 | 520 | 128.2 | 476 | 139 | 439 |
| 107 | 571 | 117.8 | 518 | 128.5 | 475 | 139.2 | 438 |
| 107.2 | 570 | 118 | 517 | 128.8 | 474 | 139.5 | 437 |
| 107.5 | 568 | 118.2 | 516 | 129 | 473 | 139.8 | 436 |
| 107.8 | 566 | 118.5 | 515 | 129.2 | 472 | 140 | 436 |
| 108 | 565 | 118.8 | 514 | 129.5 | 471 | 140.2 | 435 |
| 108.2 | 564 | 119 | 513 | 129.8 | 470 | 140.5 | 434 |
| 108.5 | 563 | 119.2 | 512 | 130 | 469 | 140.8 | 433 |
| 108.8 | 561 | 119.5 | 511 | 130.2 | 469 | 141 | 433 |
| 109 | 560 | 119.8 | 510 | 130.5 | 468 | 141.2 | 432 |
| 109.2 | 559 | 120 | 509 | 130.8 | 467 | 141.5 | 431 |
| 109.5 | 558 | 120.2 | 508 | 131 | 466 | 141.8 | 430 |
| 109.8 | 556 | 120.5 | 507 | 131.2 | 465 | 142 | 430 |
| 110 | 555 | 120.8 | 505 | 131.5 | 464 | 142.2 | 429 |
| 110.2 | 554 | 121 | 504 | 131.8 | 463 | 142.5 | 428 |
| 110.5 | 553 | 121.2 | 504 | 132 | 462 | 142.8 | 427 |
| 110.8 | 551 | 121.5 | 502 | 132.2 | 462 | 143 | 427 |
| 111 | 550 | 121.8 | 501 | 132.5 | 461 | 143.2 | 426 |
| 111.2 | 549 | 122 | 500 | 132.8 | 460 | 143.5 | 425 |
| 111.5 | 548 | 122.2 | 500 | 133 | 459 | 143.8 | 424 |
| 111.8 | 546 | 122.5 | 498 | 133.2 | 458 | 144 | 424 |
| 112 | 545 | 122.8 | 497 | 133.5 | 457 | 144.2 | 423 |
| 112.2 | 544 | 123 | 496 | 133.8 | 456 | 144.5 | 422 |
| 112.5 | 543 | 123.2 | 495 | 134 | 455 | 144.8 | 421 |
| 112.8 | 541 | 123.5 | 494 | 134.2 | 455 | 145 | 421 |
| 113 | 540 | 123.8 | 493 | 134.5 | 454 | 145.2 | 420 |
| 113.2 | 539 | 124 | 492 | 134.8 | 453 | 145.5 | 419 |
| 113.5 | 538 | 124.2 | 491 | 135 | 452 | 145.8 | 418 |

Table 5-8. Subtense using a 60 meter base (continued)

| ANGLE | DISTANCE | ANGLE | DISTANCE | ANGLE | DISTANCE | ANGLE | DISTANCE |
|-------|----------|-------|----------|-------|----------|-------|----------|
| 146 | 418 | 156.8 | 389 | 167.5 | 364 | 178.2 | 342 |
| 146.2 | 417 | 157 | 388 | 167.8 | 363 | 178.5 | 342 |
| 146.5 | 416 | 157.2 | 388 | 168 | 363 | 178.8 | 341 |
| 146.8 | 416 | 157.5 | 387 | 168.2 | 363 | 179 | 341 |
| 147 | 415 | 157.8 | 387 | 168.5 | 362 | 179.2 | 340 |
| 147.2 | 414 | 158 | 386 | 168.8 | 361 | 179.5 | 340 |
| 147.5 | 414 | 158.2 | 386 | 169 | 361 | 179.8 | 339 |
| 147.8 | 413 | 158.5 | 385 | 169.2 | 360 | 180 | 339 |
| 148 | 412 | 158.8 | 384 | 169.5 | 360 | 180.2 | 338 |
| 148.2 | 412 | 159 | 384 | 169.8 | 359 | 180.5 | 338 |
| 148.5 | 411 | 159.2 | 383 | 170 | 359 | 180.8 | 337 |
| 148.8 | 410 | 159.5 | 382 | 170.2 | 358 | 181 | 337 |
| 149 | 409 | 159.8 | 382 | 170.5 | 358 | 181.2 | 336 |
| 149.2 | 409 | 160 | 381 | 170.8 | 357 | 181.5 | 336 |
| 149.5 | 408 | 160.2 | 381 | 171 | 357 | 181.8 | 335 |
| 149.8 | 407 | 160.5 | 380 | 171.2 | 356 | 182 | 335 |
| 150 | 407 | 160.8 | 379 | 171.5 | 356 | 182.2 | 335 |
| 150.2 | 406 | 161 | 379 | 171.8 | 355 | 182.5 | 334 |
| 150.5 | 405 | 161.2 | 378 | 172 | 354 | 182.8 | 333 |
| 150.8 | 405 | 161.5 | 378 | 172.2 | 354 | 183 | 333 |
| 151 | 404 | 161.8 | 377 | 172.5 | 353 | 183.2 | 333 |
| 151.2 | 403 | 162 | 376 | 172.8 | 353 | 183.5 | 332 |
| 151.5 | 403 | 162.2 | 376 | 173 | 352 | 183.8 | 332 |
| 151.8 | 402 | 162.5 | 375 | 173.2 | 352 | 184 | 331 |
| 152 | 401 | 162.8 | 375 | 173.5 | 351 | 184.2 | 331 |
| 152.2 | 401 | 163 | 374 | 173.8 | 351 | 184.5 | 330 |
| 152.5 | 400 | 163.2 | 374 | 174 | 350 | 184.8 | 330 |
| 152.8 | 399 | 163.5 | 373 | 174.2 | 350 | 185 | 329 |
| 153 | 399 | 163.8 | 372 | 174.5 | 349 | 185.2 | 329 |
| 153.2 | 398 | 164 | 372 | 174.8 | 349 | 185.5 | 329 |
| 153.5 | 397 | 164.2 | 371 | 175 | 348 | 185.8 | 328 |
| 153.8 | 397 | 164.5 | 371 | 175.2 | 348 | 186 | 328 |
| 154 | 396 | 164.8 | 370 | 175.5 | 347 | 186.2 | 327 |
| 154.2 | 396 | 165 | 370 | 175.8 | 347 | 186.5 | 327 |
| 154.5 | 395 | 165.2 | 369 | 176 | 346 | 186.8 | 326 |
| 154.8 | 394 | 165.5 | 368 | 176.2 | 346 | 187 | 326 |
| 155 | 394 | 165.8 | 368 | 176.5 | 345 | 187.2 | 326 |
| 155.2 | 393 | 166 | 367 | 176.8 | 345 | 187.5 | 325 |
| 155.5 | 392 | 166.2 | 367 | 177 | 344 | 187.8 | 325 |
| 155.8 | 392 | 166.5 | 366 | 177.2 | 344 | 188 | 324 |
| 156 | 391 | 166.8 | 366 | 177.5 | 343 | 188.2 | 324 |
| 156.2 | 390 | 167 | 365 | 177.8 | 343 | 188.5 | 323 |
| 156.5 | 390 | 167.2 | 365 | 178 | 342 | 188.8 | 323 |

Table 5-8. Subtense using a 60 meter base (continued)

| ANGLE | DISTANCE | ANGLE | DISTANCE | ANGLE | DISTANCE | ANGLE | DISTANCE |
|-------|----------|-------|----------|-------|----------|-------|----------|
| 189 | 322 | 199.8 | 305 | 210.5 | 289 | 221.2 | 275 |
| 189.2 | 322 | 200 | 305 | 210.8 | 289 | 221.5 | 275 |
| 189.5 | 322 | 200.2 | 304 | 211 | 289 | 221.8 | 274 |
| 189.8 | 321 | 200.5 | 304 | 211.2 | 288 | 222 | 274 |
| 190 | 321 | 200.8 | 303 | 211.5 | 288 | 222.2 | 274 |
| 190.2 | 320 | 201 | 303 | 211.8 | 288 | 222.5 | 274 |
| 190.5 | 320 | 201.2 | 303 | 212 | 287 | 222.8 | 274 |
| 190.8 | 319 | 201.5 | 302 | 212.2 | 287 | 223 | 273 |
| 191 | 319 | 201.8 | 302 | 212.5 | 287 | 223.2 | 273 |
| 191.2 | 319 | 202 | 302 | 212.8 | 286 | 223.5 | 272 |
| 191.5 | 318 | 202.2 | 301 | 213 | 286 | 223.8 | 272 |
| 191.8 | 318 | 202.5 | 301 | 213.2 | 286 | 224 | 272 |
| 192 | 317 | 202.8 | 300 | 213.5 | 285 | 224.2 | 271 |
| 192.2 | 317 | 203 | 300 | 213.8 | 285 | 224.5 | 271 |
| 192.5 | 317 | 203.2 | 300 | 214 | 285 | 224.8 | 271 |
| 192.8 | 316 | 203.5 | 299 | 214.2 | 284 | 225 | 271 |
| 193 | 316 | 203.8 | 299 | 214.5 | 284 | 225.2 | 270 |
| 193.2 | 315 | 204 | 299 | 214.8 | 283 | 225.5 | 270 |
| 193.5 | 315 | 204.2 | 298 | 215 | 283 | 225.8 | 270 |
| 193.8 | 314 | 204.5 | 298 | 215.2 | 283 | 226 | 269 |
| 194 | 314 | 204.8 | 297 | 215.5 | 283 | 226.2 | 269 |
| 194.2 | 314 | 205 | 297 | 215.8 | 282 | 226.5 | 269 |
| 194.5 | 313 | 205.2 | 297 | 216 | 282 | 226.8 | 268 |
| 194.8 | 313 | 205.5 | 296 | 216.2 | 282 | 227 | 268 |
| 195 | 312 | 205.8 | 296 | 216.5 | 281 | 227.2 | 268 |
| 195.2 | 312 | 206 | 296 | 216.8 | 281 | 227.5 | 268 |
| 195.5 | 312 | 206.2 | 295 | 217 | 281 | 227.8 | 267 |
| 195.8 | 311 | 206.5 | 295 | 217.2 | 280 | 228 | 267 |
| 196 | 311 | 206.8 | 295 | 217.5 | 280 | 228.2 | 267 |
| 196.2 | 311 | 207 | 294 | 217.8 | 280 | 228.5 | 266 |
| 196.5 | 310 | 207.2 | 294 | 218 | 279 | 228.8 | 266 |
| 196.8 | 310 | 207.5 | 294 | 218.2 | 279 | 229 | 266 |
| 197 | 309 | 207.8 | 293 | 218.5 | 279 | 229.2 | 266 |
| 197.2 | 309 | 208 | 293 | 218.8 | 278 | 229.5 | 265 |
| 197.5 | 308 | 208.2 | 293 | 219 | 278 | 229.8 | 265 |
| 197.8 | 308 | 208.5 | 292 | 219.2 | 278 | 230 | 265 |
| 198 | 308 | 208.8 | 292 | 219.5 | 277 | 230.2 | 264 |
| 198.2 | 307 | 209 | 291 | 219.8 | 277 | 230.5 | 264 |
| 198.5 | 307 | 209.2 | 291 | 220 | 277 | 230.8 | 264 |
| 198.8 | 306 | 209.5 | 291 | 220.2 | 276 | 231 | 263 |
| 199 | 306 | 209.8 | 290 | 220.5 | 276 | 231.2 | 263 |
| 199.2 | 306 | 210 | 290 | 220.8 | 276 | 231.5 | 263 |
| 199.5 | 305 | 210.2 | 290 | 221 | 275 | 231.8 | 263 |

Table 5-8. Subtense using a 60 meter base (continued)

| ANGLE | DISTANCE | ANGLE | DISTANCE | ANGLE | DISTANCE | ANGLE | DISTANCE |
|-------|----------|-------|----------|-------|----------|-------|----------|
| 232 | 262 | 234.5 | 259 | 237 | 257 | 239.5 | 254 |
| 232.2 | 262 | 234.8 | 259 | 237.2 | 256 | 239.8 | 254 |
| 232.5 | 262 | 235 | 259 | 237.5 | 256 | 240 | 253 |
| 232.8 | 261 | 235.2 | 259 | 237.8 | 256 | | |
| 233 | 261 | 235.5 | 258 | 238 | 256 | | |
| 233.2 | 261 | 235.8 | 258 | 238.2 | 255 | | |
| 233.5 | 261 | 236 | 258 | 238.5 | 255 | | |
| 233.8 | 260 | 236.2 | 258 | 238.8 | 255 | | |
| 234 | 260 | 236.5 | 257 | 239 | 255 | | |
| 234.2 | 260 | 236.8 | 257 | 239.2 | 254 | | |

5-11. AUTOMATED COMPUTATIONS

a. The BCS and LCU allow battery commanders to disperse their howitzers over larger position areas than ever before. BCS and BUCS have weapon location routines that allow us to determine the grid location and altitude of each howitzer by simply entering the azimuth, distance, and vertical angle to the howitzer from the orienting station (mnemonic ORSTA). Thus, we can use this application to help us determine grid locations and altitudes to traverse stations while performing a graphic traverse.

b. Location and altitude at each of the traverse stations are determined by entering a number of successive polar coordinates (direction, distance, and vertical angle) in the weapon location file.

5-12. AFU INPUT FOR GRAPHIC TRAVERSE USING BUCS, REV 1

Note: ST 6-40-31 is the user's manual for BUCS Rev 1. Any Rev 1 read only memory (ROM) can be used for this procedure. The caliber of weapon system does not matter. The only information required in the database to begin this procedure is the map modification (MAPMOD).

Follow the steps and information in Table 5-9 to determine location and altitude with BUCS.

Table 5-9. AFU input for graphic traverse

| STEP | DISPLAY | ACTION TAKEN |
|------|--------------------|-------------------|
| 1 | MAIN (?FDISAP★): | Select D, endline |
| 2 | DATA (?GUAMOTRF★): | Select U, endline |
| 3 | UPDATE FU (?OPM★): | Select O, endline |

| STEP | DISPLAY | ACTION TAKEN |
|---|--------------------------|---|
| 4 | Weapon System REV1(?I★): | Displays weapon system module identification. (Any weapon may be used.) endline |
| <p>a. For steps 5-8, default values are displayed. If data are correct, press endline and proceed to the next step. Otherwise, enter new data, as required. Azimuth of lay, deflection, and propellant temperature are not used in the computation of a graphic traverse.</p> | | |
| 5 | AZ LAY (P★):0 | Select endline |
| 6 | REF DEFL(P★): | Select endline |
| 7 | PROP TEMP(P★): | Select endline |
| 8 | BTRY GZ(P★): | Select endline |
| <p>Note: Universal transverse mercator (UTM) coordinates (long coordinates) are preferred; however, short coordinates may be entered if within the MAPMOD. For this procedure, orienting station (ORSTA) is considered the start point for the traverse.</p> | | |
| 9 | ORSTA LOC(?IP★): | To input, select I, endline |
| 10 | EAST(P★):00000 | Enter OS (start point) easting, endline |
| 11 | NORTH(P★):00000 | Enter OS (start point) northing, endline |
| 12 | ALT(P★):0000 | Enter OS (start point) altitude, endline |
| <p>b. Note that the ORSTA (starting point) data have been entered.</p> | | |
| 13 | ORSTB LOC (?IP★): | Select endline |

| STEP | DISPLAY | ACTION TAKEN |
|--|-----------------------|---|
| <p>c. Orienting station B (ORSTB) is not used for this procedure. If ORSTB has been previously entered in the BUCS, select ★ and endline to return to the UPDATE FU index. If ORSTB has not previously been stored in the BUCS, NOORSTB (IP ★) will appear. Press endline and go to step 14. The following steps are used to compute the traverse fieldwork.</p> | | |
| 14 | UPDATE FU (OPM ★): | Select P, endline |
| <p>d. If the computer already contains grid coordinates for a howitzer number used in the graphic traverse, select D to delete the location of that howitzer because the first forward station will be entered as gun 1.</p> | | |
| 15 | #1 BUMP# (?IDGP ★): | Select I, endline |
| 16 | BUMPER #(P ★): | Enter bumper #, endline (any bumper # can be used with first character—A to Z; second and third character—0 to 9) |
| 17 | FROM GUN # (?AB#P ★): | Enter A, endline |
| <p>e. The orienting station A (ORSTA) is the starting point for the traverse.</p> | | |
| 18 | DIR(P ★): | Enter azimuth (known azimuth plus the station angle), endline |
| 19 | DIST(P ★): | Enter distance (determined from fieldwork, endline) |
| <p>Note: To use subtense distance, press endline at step 19 and SUBTENDE (P ★): is displayed. Enter the angle measured between the left and right ends of the subtense bar (in mils). Press endline and BASE LENGTH(P ★): is displayed. Enter the length of the subtense bar, in meters, and press endline. The entries "M16," "M16A1," or "M16A2" are not options.</p> | | |
| 20 | VERT ANG(P ★): | Enter vertical angle, endline |
| <p>f. All data needed to compute the coordinates and height of the first traverse station (forward station) are entered upon completion of step 20. This is the end of the first leg. g. #2 BUMP # (?IDGP ★): is displayed when endline is pressed in step 20. h. If only one leg is entered, select ★, endline. UPDATE FU (?OPM ★): will appear. Go to step 27. i. To enter fieldwork for an additional forward station, perform steps 21 to 26.</p> | | |
| 21 | #2 BUMP# (IDGP ★): | Select I, endline |
| 22 | BUMPER #(P ★): | Enter bumper # |
| 23 | FROM GUN # (?AB#P ★): | Enter 1, endline |

| STEP | DISPLAY | ACTION TAKEN |
|---|---------------------------|--|
| <p>Note: TS-1 is now the occupied station; therefore, a 1 is entered to indicate the start point of the second leg. This process is the same for all subsequent legs.</p> | | |
| 24 | DIR(P ★): | Enter azimuth (forward azimuth from TS-1 to TS-2), endline |
| 25 | DIST(P ★): | Enter distance (TS-1 to TS-2), endline |
| 26 | VERT ANG(P ★): | Enter vertical angle, endline |
| <p>j. All data needed to compute the coordinates and height of the second forward position are entered. This is the end of the second leg. k. To enter the fieldwork for additional forward stations, perform steps 21 to 26 again. Each time an additional leg is entered into the program, the number in step 21 is incremented by 1 and the number in step 23 is the last traverse station. l. The number of traverse stations (forward station) is not to exceed eight. m. To determine grid coordinates of each traverse station, 2 methods are available. (1) Method 1. Method 1 is a review of the data that was entered into the computer in the order that it was entered. The grid coordinates for each traverse station are reviewed and recorded in the order that the fieldwork was entered in the BUCS; that is, the first station, the second, and so forth.</p> | | |
| 27 | #_BUMP#_(?IDGP ★): | Select ★, endline (The BUCS will jump to UPDATE FU index.) |
| <p>(a) Review and extract the grid coordinates of each traverse station. Begin by reviewing your starting point (ORSTA) to ensure it is correct.</p> | | |
| 28 | UPDATE FU (?OPM ★): | Select O, endline |
| 29 | Weapon System REV1(?I ★): | Endline |
| 30 | AZ LAY(P ★): | Endline |
| 31 | REF DEFL(P ★): | Endline |
| 32 | PROP TEMP(P ★): | Endline |
| 33 | BTRY GZ(P ★): | Endline |
| <p>Note: Steps 29 to 33 display the same data entered in steps 4 to 8. Steps 35 to 37 display the OS (start point) data entered in steps 10 to 12. Steps 40 to 43 display the grid coordinates of each traverse station.</p> | | |
| 34 | ORSTA LOC(?IP ★): | Endline |
| 35 | OS E____(P ★): | Endline |
| 36 | OS N____(P ★): | Endline |

| STEP | DISPLAY | ACTION TAKEN |
|--|----------------------|--------------------------------------|
| 37 | ALT__ GZ__ (P★): | Endline |
| 38 | ORSTB LOC(IP★): | Select ★, endline (ORSTBwasnotused.) |
| 39 | UPDATE FU (?OPM★): | Select P, endline |
| <p>Note: The number that appears after the # symbol in steps 40 to 43 is the number of the first forward station computed. The easting, northing, and altitude should be recorded, if required. Remember: When performing a graphic traverse, keep track of the number of forward stations.</p> | | |
| 40 | #_ BUMP#_ (?IDGP★_): | Endline |
| 41 | #_ E___ (P★): | Endline |
| 42 | #_ N___ (P★): | Endline |
| 43 | #_ ALT___ (P★): | Endline |
| <p>(b) If the location of subsequent forward stations is desired, continue to press endline. The prompts for steps 40 to 43 will appear. Note that the number in each prompt is increased by each forward station (Example: Four forward stations and the prompt #4E 123456(P★) appears). The easting, northing, and altitude are the data of the last forward station in the survey.</p> <p>(c) After all required coordinates are retrieved, select ★, endline to return to the UPDATE FU index. Select ★, endline to return to the DATA INDEX.</p> <p>(2) Method 2. Method 2 starts at the same location as method 1 (step 27). The difference between method 1 and method 2 is that method 2 backs up through the program. This allows the computed data for the last forward station entered to be reviewed and recorded first.</p> | | |
| 27 | #_ BUMP#_ (?IDGP★): | Select P, endline |
| <p>Note: Remember, at this point in the program, the number following the # symbol will be one larger than the number of forward station entered.</p> | | |

| STEP | DISPLAY | ACTION TAKEN |
|--|---------------------|-------------------|
| 28 | #_ BUMP#_ (?IDGP★): | Endline |
| <p>Note: The number following the # symbol will be the number of the last forward station computed. Steps 29 to 31 display the coordinates of the last forward station.</p> | | |
| 29 | #_ E___ (P★): | Endline |
| 30 | #_ N___ (P★): | Endline |
| 31 | #_ ALT___ (P★): | Endline |
| 32 | #_ BUMP#_ (?IDGP★): | Select P, endline |
| <p>Note: At this point in the program, all the desired data for the last forward station is recorded, if required. Pressing P, endline will cause the computer to return to the BUMP# of the last forward station, again.</p> | | |
| 33 | #_ BUMP#_ (?IDGP★): | Select P, endline |
| | #_ BUMP#_ (?IDGP★): | Endline |
| <p>Note: The number following the # symbol in step 34 is the number of the next-to-last forward station. The use of endline through the ALT data will provide all the data for this station. You can continue this process all the way back to the first forward station. If only the last forward station coordinates are required, they are extracted by using only steps 27 to 31 of method 2.</p> | | |

5-13. ALTITUDE DETERMINATION

In the absence of altitude data provided by battalion surveyors, altitude is obtained directly from the map. Once the coordinates of the desired point have been determined by the precision lightweight GPS receiver, graphic resection or graphic traverse, the altitude of this point is taken from the map sheet. Normally, altitude can be considered to be accurate to half the contour interval.

CHAPTER 6
MINIMUM QUADRANT ELEVATION

6-1. RESPONSIBILITIES

The platoon leader is responsible for determining the lowest quadrant elevation that can be safely fired from his platoon position that will ensure projectiles clear all visible crests.

Note: All references to platoon leader will apply to the executive officer as well. Also, the gunnery sergeant is responsible for these same duties prior to the platoon's occupation of position.

6-2. ELEMENTS OF COMPUTATION

Use of the rapid fire tables (Appendix K) is the fastest method of computing minimum quadrant elevation (min QE). Manual computations are more accurate than the rapid fire tables and must be used if the sum of the vertical angle and the angle needed for a 5-meter clearance is greater than 300 mils. The tables were not constructed for the value of the sum of Angles 1 and 2 to exceed 300 mils. Figure 6-1 shows the elements of minimum quadrant elevation.

a. Piece-to-crest range (PCR) is the horizontal distance between the piece and the crest, expressed to the nearest 100 meters. Procedures for measurement are discussed in paragraph 6-4.

b. Angle 1, Figure 6-1, is the angle of site to crest for the weapon. See paragraph 6-3 for measuring procedures. The largest site to crest will not necessarily yield the largest minimum quadrant.

c. Angle 2, Figure 6-1, is the vertical angle required to clear the top of the crest. For quick, time, and unarmed proximity (VT) fuzes, a vertical clearance of 5 meters is used. For armed VT fuzes, see paragraph 6-6.

d. Angle 3, Figure 6-1, is the complementary angle of site (comp site). It is the comp site factor (from the TFT, Table G) for the appropriate charge at the piece-to-crest range multiplied by the sum of Angles 1 and 2. If the PCR is not a listed value, use the next higher listed PCR. Site (si) is the sum of Angles 1, 2, and 3.

e. Angle 4, Figure 6-1, is the elevation for the appropriate charge corresponding to the PCR. A large PCR may cause the value of Angle 4 to override the effects of site to crest (Angle 1). Therefore, **minimum quadrant must be computed for each weapon and each charge to be fired.**

f. Angle 5, Figure 6-1, is a safety factor equivalent to the value of 2 forks (from the TFT, Table F) for the appropriate charge at the PCR.

g. The greatest sum of Angles 1-5, Figure 6-1, is the minimum quadrant elevation for the charge computed.

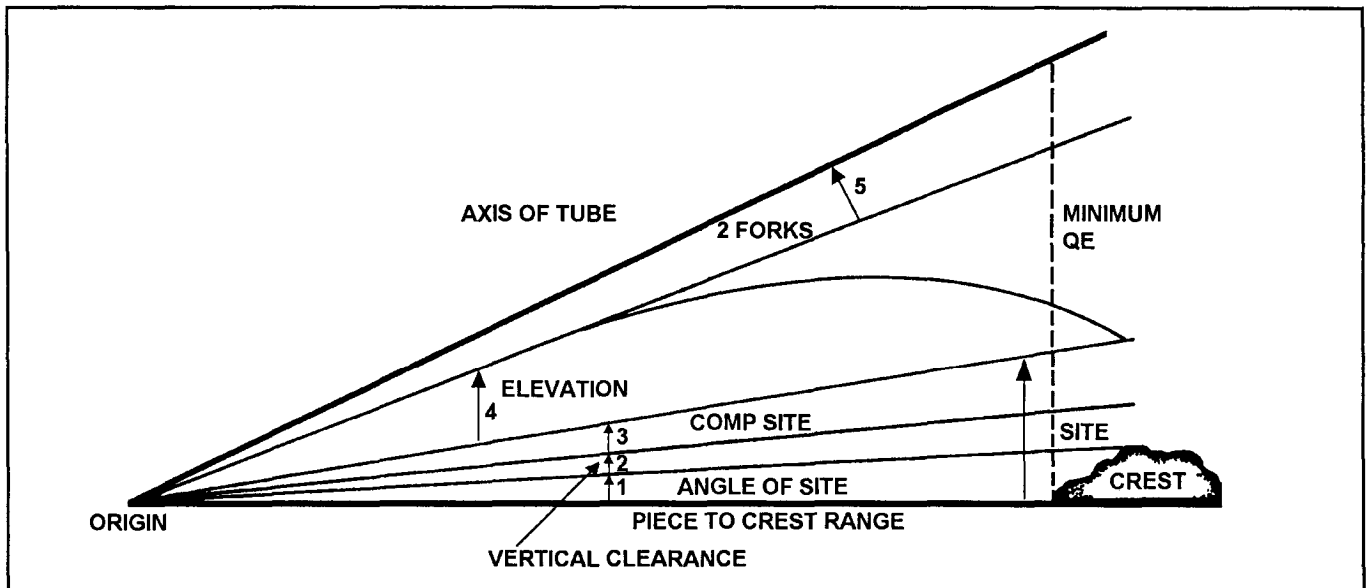

Figure 6-1. Angles in platoon leader's minimum QE

6-3. MEASURING ANGLE OF SITE TO CREST

During advance party operations, site to crest is measured with the M2 compass or M2A2 aiming circle (refer to chapter 4 for these procedures). If the M2 compass is used, add 20 mils to allow for the accuracy of the M2 compass. During position improvement, the chief of section verifies the angle of site to the crest and reports it to the platoon leader. To verify the angle of site to crest, the chief of section, sights along the bottom edge of the bore, has the tube traversed across the probable field of fire and has the tube elevated until the line of sight clears the crest at the highest point. He then centers all bubbles on the elevation mount, and reads the angle of site to the crest from the elevation counter. The angle of site is read and expressed to the nearest whole mil. This angle of site and PCR are reported as part of the section chief's report (paragraph 2-20).

6-4. MEASURING PIECE-TO-CREST RANGE

a. There are five methods that can be used to measure piece-to-crest range:

(1) **Taping**, the most accurate method, is normally too time consuming.

(2) **Subtense** is fast and accurate.

(3) **Map measurement** is fast and accurate if the obstacle can be located (for example, a lone tree will not appear on a map).

(4) **Pacing** is time-consuming and dependent on the distance and accessibility to the crest.

(5) **Estimation** is least accurate, but it is used when other methods are not feasible.

b. Regardless of the method used, PCR must be verified by the gunnery sergeant or platoon leader before computing minimum quadrant elevation. He can do this by measuring by one of the five methods listed above and comparing the results.

6-5. COMPUTATION FOR FUZES OTHER THAN ARMED VARIABLE TIME

a. The gunnery sergeant or platoon leader performs the computations indicated in this section if the sum of angles 1 and 2, Figure 6-1, exceeds 300 mils or if the rapid fire tables are not available. All angles are determined and expressed to the **next higher whole mil**. He performs the computation for **all** howitzers. The example below shows his computations.

b. One howitzer section may report a sight to crest that is unusually high. If the platoon leader determines that it is due to a single narrow obstruction (such as a tree), that piece may be called out of action when firing deflections that would engage the obstruction. This would enable the platoon to use the next lower minimum quadrant. Other alternatives are to remove the obstruction or move the weapon.

EXAMPLE

Gun 1 has a range to crest of 1,100 meters; the angle of site to crest reported is +16 mils. Gun 1 is an M109A2 155-mm howitzer, and charge 3 green bag will be fired. The platoon leader does the following:

Note: All computations are derived from AM-2 TFTs, graphical firing tables (GFTs), and graphical site tables (GSTs).

- Angle 1: Records the angle of site reported by the chief of section +16 mils
- Angle 2: Determines the vertical clearance in mils. He uses the GST to divide the vertical clearance in meters (5 meters) by the PCR in thousands (1.1). This value, read under the M gage point, is 4.6, and is expressed to the next higher whole mil.
..... +5 mils

Note: The value for angle 2 can also be extracted from the rapid fire tables (Appendix K).

- Angle 3: Determines comp site by multiplying the comp site factor corresponding to the piece-to-crest range (or the next higher listed range in the TFT, Table G, if that range is not listed) by the sum of angles 1 and 2. Angle 1 + Angle 2 = +21. The comp site factor corresponding to 1,500 meters (range 1100 is not listed in Table G) is +0.010. Therefore, +21 x 0.010 = +0.210. Once a value for comp site has been determined, it must be expressed to the next higher whole mil.
..... +1 mil
- Angle 4: Determines elevation for the PCR (TFT, Table F, column 2). If this value is not a whole number, it is expressed to the next higher whole mil (74.1 expressed to 75) +75 mils
- Angle 5: Determines the value of 2 forks (TFT, Table F, column 6) at PCR (2 x +2 mils) +4 mils
- Total: Add angles 1-5 to determine the platoon leader's minimum quadrant elevation.

16+5+1+75+4=101 mils QE, charge 3 GB

Therefore, the min QE for Gun #1, Chg 3GB, is 101 mils. The platoon leader will compute the min QE for each howitzer in his firing unit. The highest value is the XO min QE for his firing unit with this charge.

6-6. COMPUTING FOR ARMED VT FUZES (LOW-ANGLE FIRE)

The method of computing the XO's minimum QE for firing a projectile fuze with an M513, M514, M728, or M732 fuze depends on the method in which the fuze is used.

a. The proximity (VT) fuze is designed to arm 3 seconds prior to the time set on the fuze; however, some VT fuzes have armed as early as 5.5 seconds prior to the time set on the fuze. Because of the probability of premature arming, a safety factor of 5.5 seconds must be added to the time of flight corresponding to the PCR. Since time on the setting ring is set to the whole second, the time determined is expressed up to the next higher whole second. A VT fuze is designed so that it will not arm earlier than 2 seconds time of flight, which makes it a bore-safe fuze.

b. In combat situations, the platoon leader determines the minimum safe time and minimum quadrant elevation at the piece-to-crest range. The QE determined for PD fuze rounds is safe for VT fuzes if the time set is greater than the min safe time determined (paragraph a above). If the platoon leader finds it necessary to fire a VT fuze with a time less than the min safe time, the vertical clearance for the minimum QE must be increased to ensure the fuze will not function as it passes over the crest.

c. If the projectile is to be fired with the VT fuze set at a time less than the minimum safe time, allowance must be made for vertical clearance of friendly elements. Vertical crest clearances for M513, M514, M728, and M732 VT fuzes fired over ordinary terrain are shown in Table 6-1.

Table 6-1. Vertical clearance

| WEAPON | VERTICAL CLEARANCE FOR FUZES | |
|-----------------|------------------------------|-----------|
| | M514/513 | M728/732 |
| 105-mm howitzer | 80 meters | 70 meters |
| 155-mm howitzer | 100 meters | 70 meters |

d. If the projectile is to be fired over marshy or wet terrain, the average height of burst will increase. Therefore, the vertical clearance shown in Table 6-1 should be increased by 50 percent. If the projectile is to be fired over water, snow, or ice, the vertical clearance shown in Table 6-1 should be increased by 100 percent.

e. The minimum QE for fuze VT, when a fuze setting less than the minimum safe time is fired, is based on PCR and

a greater vertical clearance as indicated in Table 6-1 instead of the 5 meters as stated in paragraph 6-2c.

f. The following is an example of computations to determine minimum QE for armed VT fuzes.

EXAMPLE

The howitzer is a 155-mm M109A3, charge 4 green bag, and armed variable time fuzes (M514) are to be fired. The angle of site reported by the chief of section is +16 mils. The PCR is 1,700 meters. The platoon leader computes the minimum QE as follows:

- ANGLE 1: The angle of site to crest reported by the chief of section +16 mils
- ANGLE 2: The vertical clearance in mils. Divide the vertical clearance in meters (100 meters) by the PCR of 1,700 meters in thousands (1.7). By reading under the M gage point of the GST, derive a value of +59 +59 mils
- ANGLE 3: Comp site for PCR of 1,700 meters (FT 155-AM-2, Table G, charge 4 GB, column 12, range 2,000 meters gives a comp site factor of 0.010). $16 + 59 = 75.75 \times 0.010 = +0.750$ expressed to the next higher whole mil +1 mils
- ANGLE 4: Elevation at PCR (TFT, Table F, column 2). (90.0) +90 mils
- ANGLE 5: The value of 2 forks at PCR (TFT, Table F, column 6). (2 x 2 mils) +4 mils
- Minimum safe time (time of flight [TOF] at the PCR = $5.6 + 5.5 = 11.1$ or 12.0 seconds) 12.0 seconds

The MINIMUM QUADRANT ELEVATION FOR THIS GUN IS 170 MILS, CHARGE 4 GREEN BAG, MINIMUM SAFE TIME 12.0 SECONDS (M514), FUZE ARMED VT.

The platoon leader will compute the min QE for each gun in his firing unit. The highest value is the XO min QE for his firing unit with this charge.

g. If the fuze setting to be fired is **equal to or greater than** the minimum safe time, the minimum QE determined for fuzes quick and time applies. If the fuze setting to be fired is **less than** the minimum safe time, the minimum quadrant elevation determined for armed VT applies.

h. Table 6-2 is a recapitulation of the steps for computing minimum quadrant elevation. It should be used as a reference by the platoon leader and in training individuals to compute minimum quadrant elevation.

i. The XO min QE is compared to the min QE to the minimum range line as computed by the FDC. The greater of these two values is placed on the safety T.

Table 6-2. Computation of minimum quadrant elevation

| ELEMENTS OF COMPUTATION | HOW TO DO THE COMPUTATION | | |
|---|--|--|---|
| | Fuze PD, Fuze MTSQ, or Fuze VT With a Fuze Setting Equal to or Greater Than Minimum Safe Time | Fuze VT With a Fuze Setting Less Than Minimum Safe Time | |
| | | PCR Greater Than Minimum Arming Range | Minimum Arming Range Greater Than PCR |
| Angle 1: Angle of site reported | As reported | As reported | As reported |
| Angle 2: Vertical angle for clearance of friendly elements | 5 meters divided by PCR expressed up to a whole mil | Appropriate vertical clearance divided by PCR | Appropriate vertical clearance divided by minimum arming range |
| Angle 3: Complementary angle of site | Comp site factor at PCR (or next greater listed range) multiplied by the sum of Angles 1 and 2 | Comp site factor at PCR (or next greater listed range) multiplied by the sum of Angles 1 and 2 | Comp site factor at minimum arming range (or next greater listed range) multiplied by the sum of Angles 1 and 2 |
| Angle 4: Elevation | At PCR | At PCR | At minimum arming range |
| Angle 5: 2 forks | At PCR | At PCR | At minimum arming range |
| Note: All angles above are expressed up to the next higher whole mil. The sum of Angles 1 through 5 equals minimum QE. | | | |
| <p>CAUTION</p> <p>A large PCR may cause the value of Angle 4 to override the effects of site to crest (Angle 1). Therefore, minimum quadrant elevation must be computed for each weapon and charge to be fired.</p> | | | |

CHAPTER 7

FIRE COMMANDS AND FIRING REPORTS

7-1. DEFINITIONS

Fire commands are used by the FDC to give the howitzer sections all the information necessary to start, conduct, and cease firing. In a battery without BCS, fire commands must be sent by voice. In a battery using BCS, fire commands are sent digitally from the computer to the gun display unit (GDU) at the howitzer. Initial fire commands include all elements necessary for orienting, loading, and firing the piece. Subsequent fire commands must include only those elements that have changed, **except** quadrant elevation. Quadrant elevation is given in every fire command and allows the howitzer section to load and fire, if in a when ready (WR) status.

Note: Section chiefs must completely view the entire digital fire command on every round. In the race to be first, they may look only at charge, deflection, and quadrant elevation. This creates obvious problems when the fire for effect (FFE) is entered or if shell, fuze, and fuze setting are changed.

7-2. SEQUENCE OF FIRE COMMANDS

a. The elements of a fire command are always given in the same sequence (Table 7-1). This saves time and confusion; each member of the section knows the sequence and can anticipate what is coming next. This sequence allows actions to occur at the same time. For example, the propellant charge can be cut and the fuze set (if required) while the deflection and quadrant are being set.

Table 7-1. Fire commands sequence

| ELEMENT | WHEN ANNOUNCED | |
|---|---|--------------------------|
| | Initial Fire Commands | Subsequent Fire Commands |
| 1. Warning order | Always | Never |
| 2. Pieces to follow ¹ Pieces to fire ¹ Method of fire ¹ | When applicable When other than standard When other than standard | When changed |
| 3. Special instructions <ul style="list-style-type: none"> • Do not load • At my command • High angle • Use gunner's quadrant • Azimuth • Special corrections • Sweep and/or zone fire | When applicable | When changed |
| 4. Projectile ¹ | When other than standard | When changed |
| 5. Ammunition lot ¹ | When other than standard | When changed |
| 6. Charge | Always | When changed |
| 7. Fuze ¹ | When other than standard | When changed |
| 8. Fuze setting ¹ | When other than standard | When changed |
| 9. Deflection | Always | When changed |
| 10. Quadrant | Always | Always |
| 11. Method of fire for effect | When applicable | When changed |

¹ These elements may be designated as standard. Elements so designated will be announced only when something other than standard is to be fired.

b. Certain elements of the fire command may be standard and these need not be sent on each subsequent fire command. Quadrant elevation may never be standardized. It is given in each fire command.

7-3. TYPES OF FIRE COMMANDS

a. **Digital Fire Commands.** Digital fire commands are used by units equipped with BCS. The entire fire command is displayed on the section chiefs assembly (SCA). Also the deflection is displayed on the gunner's gun assembly (GA) and the quadrant elevation is displayed on the assistant gunner's GA. The section chief, however, still announces the entire fire command, including the deflection and quadrant. As a data check, the gunner and assistant gunner read back the deflection and quadrant. The section chief can recall specific parts of the fire command by depressing the appropriate key on the SCA. (See Appendix L.)

b. **Voice Fire Commands.** Voice fire commands are used by units without BCS, or in the event the equipment fails to function properly. To facilitate the use of voice commands, the FDC will provide the fire command standards to the section chief when the unit first occupies the position. Fire command standards are discussed in more detail in paragraph 7-24.

c. **Degraded Digital Communications.** For BCS-equipped units, digital communications are the primary means for transmitting fire commands. If lost or degraded, communications should be reestablished as soon as possible. A solution to degraded digital communications is to use the BCS purely as a technical fire direction computer and send the data by voice.

(1) If one howitzer in the battery or platoon loses digital communications, the FDC sends voice commands to that howitzer. (All parties should try to reestablish the digital capability.)

(2) If two or more howitzers lose digital communications, the battery or platoon notifies them by voice to go to the degraded GDU mode. The howitzers will ignore GDU data and take all voice fire commands.

(3) In the degraded GDU mode, the FDC may compute data, deflection and quadrant, from the base piece to center of target and send data to the guns by voice.

(a) If the FDC uses TGPCs, these will be applied and used until the command **CANCEL TGPCs** is given by the FDC. This command is usually given after digital communications are reestablished.

(b) Time permitting, FDC will send firing data for each individual howitzer. When this occurs, FFE may be **AT MY**

COMMAND (AMC) to maintain the element of surprise and achieve maximum effect on the target.

7-4. ELEMENTS OF THE FIRE COMMAND

The elements of the fire command are discussed in paragraphs 7-5 through 7-15 below.

7-5. WARNING ORDER

A warning order is always announced to alert the firing unit to the mission. In a BCS-equipped battery, the warning order is a steady alarm signal from the case assembly of the GDU, which indicates the start of the fire mission. The section chief depresses the cycle key of his SCA to silence the alarm and acknowledge the receipt of fire commands. When a firing battery is using voice commands, a warning order of **FIRE MISSION** is announced. The warning order is not given in subsequent commands.

7-6. PIECES TO FOLLOW, PIECES TO FIRE, AND METHOD OF FIRE

This element designates the weapons that will follow the mission, the weapon(s) that will fire initially, and how they will engage the target.

a. **Pieces to follow** tells the platoon who will follow the commands given for an adjust-fire mission. **BATTERY ADJUST** or **PLATOON ADJUST** indicates that the mission will be an adjust-fire mission and that all weapons will copy the commands, follow the mission, and participate in the FFE phase. Any weapon or number of weapons may be announced in this element; for example, **PLATOON ADJUST** or **NUMBER 1 AND NUMBER 3 ADJUST**. In a BCS-equipped unit, the do not load (DNL) indicator bars will be lit on the SCAs of those howitzers that are to follow the mission. If the mission is an FFE mission, pieces to follow is not given.

b. **Pieces to fire** indicates which weapon(s) will fire the data given in the initial fire command. **PLATOON ADJUST, NUMBER 3** indicates that during an adjust-fire mission, Number 3 will fire the initial round of adjustment.

(1) In a BCS-equipped unit, the SCA of the piece(s) to fire, (Number 3 in this example), would show 1RD ADJ and the double indicator bars under the word FIRE would light.

(2) A voice command would be **NUMBER 3, 1 ROUND**.

(3) If the mission were fire for effect, then **PLATOON** would be sent.

c. **Method of fire** tells the firing piece(s) how many rounds to fire. **PLATOON ADJUST, NUMBER 3, 1 ROUND** indicates that during this adjust-fire mission Number 3 will fire one round at the data given in the initial fire command. **PLATOON 1 ROUND** indicates a FFE mission with all weapons firing one round at the data given in the initial fire command.

7-7. SPECIAL INSTRUCTIONS

Special instructions are used when actions that are different from normal are required. Within the BCS-equipped battery, restrictive commands (**DO NOT LOAD** or **AT MY COMMAND**) are signified by the double indicator bars under DNL or AMC on the SCA. Other special instructions such as high angle, (use) gunner's quadrant, azimuth, or zone and/or sweep fire, will be displayed as digital readout in the window of the SCA when the special instruction key of the SCA is depressed. When voice commands are used, the FDC must announce the special instruction(s) to be followed. The FDC will precede a special instruction with the words **SPECIAL INSTRUCTIONS**. When more than one special instruction applies, restrictive commands should be announced first.

a. **DO NOT LOAD** is a restrictive fire command that prohibits loading and firing. The section may prepare the projectile, charge, and fuze (if applicable) and lay the howitzer for deflection; and set the quadrant elevation (or loading elevation).

(1) Digital. Double bars are lit under DNL on the SCA. When the round is to be fired, the double bars under **FIRE** on the SCA are lit and the audible alarm sounds. The section chief announces **CANCEL DO NOT LOAD, QUADRANT (so much)**. The howitzer is fired at the section chief's command unless otherwise restricted.

(2) Voice. The command from the FDC would be (**so many**) **ROUNDS, (special instruction) DO NOT LOAD**. To fire the rounds, the FDC commands **CANCEL DO NOT LOAD, QUADRANT (so much)**. This command allows the guns to load if not otherwise restricted by special instructions. The target number may be used in place of the command **QUADRANT** to allow loading and firing of preplanned targets and scheduled fires. **DO NOT LOAD** does not apply to the entire mission, it must be announced with each initial or subsequent command.

Note: **DO NOT LOAD** is a standard special instruction in a Copperhead priority mission. The Copperhead target of opportunity mission is **AT MY COMMAND**.

b. **AT MY COMMAND** (or **BY PIECE BY ROUND AT MY COMMAND**) is a restrictive command that

prohibits the battery from firing until directed to do so by the FDC.

(1) Digital. Double bars under AMC on the SCA are lit. When the section is laid, the section chief presses the **READY** key at the SCA. When the round is to be fired the double bar under **FIRE** lights and the alarm sounds.

(2) Voice. The command from the FDC would be (**so many**) **ROUNDS, SPECIAL INSTRUCTIONS AT MY COMMAND**. When directed to fire the rounds, the section(s) would fire all the rounds specified in the method of fire. The command **BY PIECE AT MY COMMAND** would direct the sections to fire all the rounds specified in the method of fire by section(s) as announced by the FDC. The command **BY ROUND, AT MY COMMAND** would direct the section(s) to fire each of the rounds in the method of fire by volley as commanded by the FDC. The command **BY PIECE, BY ROUND, AT MY COMMAND** combines the control of both commands explained above. **AT MY COMMAND** remains in effect until the FDC commands **CANCEL AT MY COMMAND** (or **BY PIECE** or **BY ROUND AT MY COMMAND**). **AT MY COMMAND** may be cancelled at any time. If the FDC has announced **QUADRANT**, the command would be **CANCEL AT MY COMMAND, QUADRANT (so much)**.

c. **HIGH ANGLE** is announced, or displayed as HA on the SCA, to alert the section that the mission is to be fired at an angle of elevation greater than 800 mils. Light artillery weapons can be elevated before loading. Medium and heavy artillery weapons normally must be loaded at loading elevation.

d. **USE GUNNER'S QUADRANT** is announced, or displayed as GQ on the SCA, when the FDC desires the gunner's quadrant be used to set or check quadrant elevation. This is more often used when firing danger close or precision fire missions, which require greater accuracy.

e. **AZIMUTH** is announced, or displayed as AZ on the SCA, to alert the sections to a large shift in the direction of fire. The command **AZIMUTH** will be followed by the azimuth in mils.

f. **SWEEP (so many) MILS, (so many) DEFLECTIONS** commands a method of fire used when the standard sheaf does not adequately cover the target and more width is required. Sweep fire provides for firing several deflections with one quadrant.

(1) Digital. A sample SCA display for sweep fire is S 105DF, which indicates sweep 10 mils, 5 deflections.

(2) Voice. A sample command is **SWEEP 10 MILS, 5 DEFLECTIONS**. The section chief computes the required

deflections and, after firing the displayed deflection, fires the remaining deflections in any order or as directed by unit SOP.

EXAMPLE

The SCA displays S 15m/3DF and a deflection of 3231. The section chief computes deflections 3216 and 3246 by subtracting 15 mils from and adding 15 mils to the displayed deflection (see Figure 7-1). After firing the displayed fire commands at deflection 3231, the section chief directs the crew in firing the computed deflections in any order. Sweep fire always includes an odd number of deflections to be fired.

| DISPLAYED DF AND QE | | |
|---------------------|------|------|
| 3246 | 3231 | 3216 |
| 306 | 306 | 306 |

Figure 7-1. Computations for sweep fire

g. ZONE (so many) MILS, (so many) QUADRANTS commands a method of fire used when the standard sheaf does not adequately cover the target and more depth is required. Zone fire provides for firing one deflection with several quadrants.

(1) Digital. A sample SCA display for zone fire is Z 53QE; that is, zone, 5 mils, 3 quadrant elevations.

(2) Voice. A sample command is **ZONE, 5 MILS, 3 QUADRANTS**. The section chief computes the required quadrant, fires the initial quadrant, and then fires the remaining quadrants in any order or as directed by unit SOP.

EXAMPLE

The SCA displays Z 10m/3QE and a quadrant elevation of 409. The section chief computes quadrants 399 and 419 by subtracting 10 mils from and adding 10 mils to the displayed quadrant (Figure 7-2). After firing the displayed fire commands at quadrant 409, the section chief directs the crew in firing the computed quadrants, in any order. Zone fire will always include an odd number of quadrants to be fired.

| DISPLAYED DF AND QE | | |
|---------------------|------|------|
| 3295 | 3295 | 3295 |
| 399 | 409 | 419 |

Figure 7-2. Computations for zone fire

h. SWEEP (so many) MILS, (so many) DEFLECTIONS, ZONE (so many) MILS, (so many) QUADRANTS commands a method of fire combining sweep fire and zone fire. Sweep and zone fire provides for firing several deflections and quadrants. On the SCA, the command is displayed in the order listed above as the chief of section

presses the cycle key (that is, S_m DF, Z_m QE). The chief of section fires the displayed commands for deflection and quadrant first and then fires all combinations of computed deflections and quadrants, in any order or as directed by unit SOP.

EXAMPLE

The SCA displays 3RD FFE, S 10m/3DF, Z 4m/3QE, DF 3200 and QE 310. The chief of section computes deflections 3190 and 3210, and quadrants 306 and 314 (Figure 7-3). After the displayed commands for deflection and quadrant (DF 3200, QE 310) are fired, each of the remaining quadrants is fired with each deflection, for a total of 27 rounds (nine deflections and quadrants multiplied by three rounds per deflection and quadrant).

| DISPLAYED DF AND QE | | |
|---------------------|---------|---------|
| DF 3210 | DF 3200 | DF 3190 |
| QE 314 | QE 314 | QE 310 |
| DF 3210 | DF 3200 | DF 3190 |
| QE 310 | QE 310 | QE 310 |
| DF 3210 | DF 3200 | DF 3190 |
| QE 306 | QE 306 | QE 306 |

Figure 7-3. Computations for sweep and zone fire

i. SPECIAL CORRECTIONS is announced or displayed on the SCA to alert the crew when a separate time, deflection, and/or quadrant will be sent to or fired by one or more gun sections.

(1) The words **SPECIAL CORRECTION(S)** should precede any special corrections that apply in the fire command. This command prevents misunderstanding and unnecessary repetition of missed special corrections. If **SPECIAL CORRECTIONS** is announced alone, it alerts the sections that separate data will be sent to one or more sections. Unit SOP and degree or training dictate how this should be implemented.

(2) **SPECIAL CORRECTION, NUMBER (so-and-so) LEFT or RIGHT (so many mils)** may be announced. These corrections are applied by the specified piece to the announced deflection and remain in effect until changed (within a fire mission) or until the command **END OF MISSION** is given. This command may be given administratively, apart from fire commands; or it may be announced in the special instructions element of a fire command. These corrections are in addition to any corrections currently on the gunner's aid.

(3) **SPECIAL CORRECTION ON NUMBER (so-and-so), OPEN or CLOSE (so many mils)** may be announced. Each piece (other than the piece specified) applies

a correction to the announced deflection on the gunner's aid. Each section chief determines his correction by multiplying the number of mils announced by the number of pieces his piece is removed from the piece announced. For example, the command **ON NUMBER 3, CLOSE 4** is given. Number 3 applies no correction. Number 1 applies left 8. Number 2 applies left 4. Number 4 applies right 4. All guns fire the announced deflection after applying their corrections to the gunner's aid. These corrections are applied to any corrections already on the gunner's aid and remain in effect until changed (within a fire mission) or until the command **END OF MISSION** is given.

(4) **SPECIAL CORRECTIONS, (LEFT, CENTER, or RIGHT) SECTOR** is announced when terrain gun position corrections for other than the primary sector are being used. If TGPCs are computed, the corrections for primary sector are set on the gunner's aid of all weapons. These corrections are announced administratively and recorded on the DA Form 5212-R. To change sectors, the FDC commands **(LEFT, CENTER or RIGHT) SECTOR**. Upon termination of the mission, the howitzer sections reapply the corrections that were in effect before the mission.

(5) **CANCEL TERRAIN CORRECTIONS** indicates that all howitzer sections are to set their gunner's aid counters to zero. At the end of the mission, the TGPCs that were in effect before the mission (usually the primary sector) will be reapplied unless the FDC directs otherwise.

7-8. PROJECTILE

This element designates the type of projectile to be used in the fire mission. The type of projectile that is to be prepared and loaded is always displayed in the SCA. When voice fire commands are being used, the projectile must be announced when it differs from standard.

7-9. AMMUNITION LOT

Ammunition lot numbers should be coded for simplicity. Separate-loading ammunition has two designators—the first letter for projectile and the second letter for the propellant. Semifixed ammunition has only a one-letter designation. The lot designators are automatically displayed at the SCA. When voice fire commands are used, the lot designators must be announced when they differ from standard.

Note: Large-quantity lots are normally set aside to be fired during registrations and missions when more uniform effect is important. Small-quantity lots should be used for missions when uniform effect is not critical. Each section will segregate ammunition by lot and keep accurate record on DA Form 4513

7-10. CHARGE

The charge indicates the amount of propellant to be used and grants permission for the crew to cut the propellant. Charge is automatically displayed on the SCA or announced by the FDC. **It is never standardized.**

7-11. FUZE

The required fuze type is announced (for example, **FUZE TIME**) or displayed on the SCA. The section chief announces the fuze displayed on SCA. Fuze is announced in subsequent command only when a change in type is desired.

Note: The GDU does not distinguish between M564 and M582 mechanical time superquick (MTSQ) fuzes displayed on the SCA. Unit SOPs must be established if both fuzes are used for the same mission.

7-12. FUZE SETTING

If fuze quick is to be fired on the delay mode, **DELAY** is announced by the FDC or displayed on the SCA. If the fuze is a mechanical type (MT), MTSQ, or proximity (VT) fuze, the fuze setting is displayed automatically on the SCA. Voice commands are announced; for example, **FUZE TIME, TIME 17.6** or **FUZE VT, TIME 17.0**.

Note: If shell DPICM is to be fired in the self-registration mode (SR), fuze setting black triangle (A) 98.0 must be announced; for example, **SHELL DPICM-SR, LOT DG, CHARGE 4, FUZE TI, TIME BLACK TRIANGLE 98.0**.

7-13. DEFLECTION

With voice commands, deflection is always announced as four digits; for example, **DEFLECTION 0321** (zero three two one) and **DEFLECTION 3300** (three three hundred). Normally, deflection is displayed on the SCA as a four digit value. If three numbers appear, assume the first number is a zero. The section chief announces deflection using four numbers. The gunner sets the announced, or displayed, deflection on the panoramic telescope and traverses the tube until he has a correct sight picture on the proper aiming point (two step deflection method). When the section chief announces deflection, the gunner reads back the deflection. After the assistant gunner (AG) has reported **QUADRANT (so much), SET**, the gunner will verify his sight picture, ensure that his bubbles are centered, and reports **DEFLECTION (so much), READY**.

7-14. QUADRANT ELEVATION

a. Quadrant elevation gives the section chief permission to load and fire the round unless otherwise restricted by special instructions or unsafe conditions. The AG sets off

the quadrant elevation announced by the FDC, or displayed on his gun assembly (for example, **QUADRANT 318**). He elevates the tube to that quadrant elevation after the projectile has been loaded. When the section chief announces quadrant, the AG reads back the quadrant that is set on the range quadrant. After the AG has centered the bubbles on the range quadrant, he reports **QUADRANT (so much), SET**.

b. To increase responsiveness, loading procedures may be changed per the unit SOP, as follows:

(1) Round is loaded on deflection. This procedure can be used when loading will not interfere with receipt of the remaining fire commands.

(2) Adjusting piece loads subsequent rounds immediately after firing. This loading method can be used for all projectile-fuze combinations not using a mechanical time fuze. It is possible that the adjusting piece may not have the correct projectile-fuze combination loaded when entering FFE. If this occurs, the loaded round is fired and the remaining FFE rounds are fired with the correct projectile-fuze combination. At the end of the mission, the chief of section reports to the FDC that his howitzer fired ammunition not specified in the fire command.

EXAMPLE

Suppose the fire command was **3 ROUNDS VT IN EFFECT**. Number 4 fired one round with fuze quick and two rounds with fuze VT. The chief of section reported **NUMBER 4 FIRED 1 QUICK AND 2 VT IN EFFECT**. The FDC then updates the ammunition count accordingly.

CAUTION

Do not leave rounds in a hot or warm tube for a period longer than that specified by the technical manual for the weapon.

(3) Nonadjusting pieces load the shell to be fired in effect on receipt of the initial fire command. This procedure also applies to all projectile-fuze combinations not using a mechanical time or VT fuzes. When fuze VT is to be fired in effect, the FDC calculates the VT fuze setting corresponding to the initial target location and sends it to the nonadjusting pieces. If terrain, weather, and enemy capabilities permit, the FDC can, **in wartime**, send the VT minimum safe time to the nonadjusting pieces.

Note: If a howitzer has automatically reloaded during the adjust phase and **END OF MISSION** is announced before the FFE phase, the following precautions should be taken:

- Leave weapon laid on last fired data.

- Announce to FDC **NUMBER (so-and-so) IS LOADED**.
- Evaluate hot or cold tube situation.
- Decide to compute safe data to shoot round, or unload weapon.

7-15. METHOD OF FIRE FOR EFFECT

This element indicates the number of rounds and type of ammunition to be used in effect. When applicable, it is announced in the initial fire command after the quadrant and must be announced before the last subsequent command in an adjust fire mission. This is displayed automatically on the SCA. With voice commands, it is announced after quadrant elevation; for example, **2 ROUNDS, FUZE VT IN EFFECT**.

7-16. SPECIAL METHODS OF FIRE

There are voice fire commands that cannot be displayed on the GDU SCA. Shown below are the commands and their definitions.

a. **CONTINUOUS FIRE** is given when it is desired that the howitzer crews continue to fire within the prescribed rates of fire for their howitzer until the command **CHECK FIRING** or **CEASE LOADING** is given.

b. **FIRE AT WILL** is used in a direct fire role, primarily for perimeter defense. The command is **TARGET (so-and-so), FIRE AT WILL**. Howitzer crews fire under the control of their section chief.

7-17. CHECK FIRING

The command **CHECK FIRING** can be given by **anyone**, but it should be used only in emergencies or if a safety violation is noted. **All firing ceases immediately**. The command may be given by voice, displayed on the SCA, and/or given by hand signals all at the same time. Immediate action must be taken to determine the nature of the check fire and to correct the situation.

Note: To give the hand signal, raise your hand in front of your forehead, palm to the front, and swing your hand and forearm up and down several times in front of your face.

7-18. CEASE LOADING

The command **CEASE LOADING** allows the firing battery to fire rounds that have already been loaded, but no additional rounds may be loaded. It is a voice command only, with the exception of final protective fire (FPF) missions processed with BCS.

7-19. END OF MISSION

The command **END OF MISSION (EOM)** means that the fire mission has been terminated. The howitzer sections should return to the azimuth of lay or priority target data. The SCA displays EOM for that howitzer; for example, **GUN (number so-and-so) EOM**.

7-20. PLANNED TARGETS

a. The battery may be assigned planned targets for which current firing data must be maintained. Each target is assigned a number and each weapon is laid on its assigned priority target. In such cases, unit SOP usually designates a command or a prearranged signal to fire on the priority target, bypassing the usual sequence of fire commands.

EXAMPLE

Target AC7343 has been designated as a priority target. Firing data have been computed and have been transmitted to one of the firing platoons. On the command **RIGHT, SUPPRESS AC7343**, the right platoon engages Target AC7343 with the previously arranged method of fire.

b. In defensive operations, the command **FIRE THE FPF** causes the firing battery to fire the final protective fires on which it is laid.

7-21. REPETITION AND CORRECTION OF FIRE COMMANDS

a. One section (normally the adjusting piece) of the firing unit should be designated to read back all voice fire commands to ensure that the howitzer sections have received the fire commands correctly. When a command has not been heard or has been misunderstood, the request for repetition is stated as a question; for example, **DEFLECTION NUMBER 2?** When the FDC replies, the repetition of a command is always preceded by **NUMBER (so-and-so), THE COMMAND WAS**; for example, **NUMBER 2, THE COMMAND WAS DEFLECTION 2768**.

b. If an incorrect command has been given, but the command **QUADRANT** has not been announced, the FDC commands **CORRECTION** followed by the correct command and all subsequent elements. If **QUADRANT** has been announced, the FDC commands **CHECK FIRING, CANCEL CHECK FIRING** is announced followed by the corrected element and all subsequent elements.

7-22. FIRING REPORTS

The section chief reports to the FDC all actions that affect the firing of his weapon in support of the battery mission. During firing, the following specific reports are made:

a. When the special instruction **DO NOT LOAD** has been commanded by the FDC the section chief reports **LAI D, NUMBER (so-and-so)**. This report is sent when the projectile, charge, and fuze (if applicable) have been prepared; the howitzer has been laid for deflection; and the quadrant (or loading elevation) has been set.

b. When the special instruction **AT MY COMMAND or BY PIECE (or BY ROUND) AT MY COMMAND** has been commanded by the FDC, the section chief reports by voice **READY, NUMBER (so-and-so)**. This report is sent when the section is ready to fire (in compliance with the fire command). The report is sent digitally by pressing the **READY** key on the SCA.

c. In voice operations, **SHOT NUMBER (so-and-so)** is reported after each round has been fired. If, however, the method of fire is more than one round, **SHOT** is announced only after the initial round. For GDU-equipped howitzers, the report is sent digitally when the section chief presses the **SHOT/RC** key once on the SCA.

d. **ROUNDS COMPLETE NUMBER (so-and-so)** is announced when the final round designated in the method of fire has been fired. If, however, only one round is to be fired, **ROUNDS COMPLETE** will not be reported after **SHOT**. For GDU-equipped howitzers, the report of rounds complete (RC) is sent when the **SHOT/RC** key on the SCA is pressed a second time. For a GDU-equipped howitzer to receive subsequent fire commands in any mission, rounds complete **must** be transmitted to the FDC.

e. **MISFIRE NUMBER (so-and-so)** is announced when a misfire has occurred (voice only).

f. Ammunition status is reported. The number of rounds expended, by type and lot number, is reported when requested by the FDC (voice or per unit SOP).

g. Data fired in error are reported. The chief of section reports to FDC the actual data fired in error; for example, **NUMBER 2 FIRED DEFLECTION (so much)**.

7-23. STANDARDIZING ELEMENTS OF THE FIRE COMMAND

Certain elements of fire commands may be standardized after the tactical situation, weapon, and personnel capabilities, ammunition status, and enemy counterfire threat have been considered. As shown in Table 7-1, the following elements of the fire command may be designated as standard: pieces to follow, pieces to fire, method of fire, projectile, ammunition lot, and fuze. If the FDO decides to vary from fire command standard data, he must administratively cancel the existing standard and issue the replacement standard data. Only one set of standard data can be in effect at any particular time.

Once standard data are placed in effect, the platoon will fire the standard data unless the fire command specifies something different.

EXAMPLE

The FDO or platoon leader considers the tactical situation and the other factors mentioned above and determines that the fire command elements designated as standard should be as follows:

- Pieces to fire and method of fire: Number 3, 1 round.
- Projectile: HE.
- Ammunition lot: XY.
- Fuze: Quick.

These standards tell the firing battery or platoon that if not stated in a fire command, the piece to fire will be Number 3, and the method of fire will be one round, shell HE, lot XY, and fuze quick.

FIRE MISSION, PLATOON ADJUST, NUMBER 3, 1 ROUND, SHELL HE, LOT XY, CHARGE 4, FUZE QUICK, DEFLECTION 3024, QUADRANT 247, 2 ROUNDS IN EFFECT.

(1) Number 3 is announced as the adjusting weapon. It fires one round (shell HE, lot XY, fuze quick) with the announced charge, and at the announced deflection, and quadrant. The rest of the platoon prepares 2 HE rounds with fuze quick and follow the fire mission.

(2) The first subsequent fire command is as follows:
DEFLECTION 2978, QUADRANT 218.

Number 3 fires one round (shell HE, lot XY, charge 4, fuze quick) at the new deflection and quadrant.

(3) The second subsequent fire command is as follows:
PLATOON 2 ROUNDS, DEFLECTION 2950, QUADRANT 210.

The entire platoon fires two rounds at the announced deflection and quadrant. END OF MISSION is commanded as appropriate. At END OF MISSION, an ammunition update is required as shown in Figure 7-4.

7-24. EXAMPLE OF FIRE COMMANDS

a. **Nonstandard Adjust-Fire Mission.** In this example, no standard elements are used. (See Figure 7-4.)

| RECORD OF MISSIONS FIRED | | SECTION | DATE | PAGE | OF | AMMUNITION/FUZES ON HAND | | | | | | | | | | | |
|---|-------------------|------------|-------------|------------|-----------|--------------------------|-----------|-----------|---------------|----------------------------|----|----|----|----|----|----------------|--|
| For use of this form, see FM 6-50. The proponent agency is US Army Training and Doctrine Command. | | C-13/#3 | Today | 1 | | HE | WP | SM | L | GB | WB | PD | TI | TI | VT | R _M | |
| | | | | | | X | D | F | J | Q | Y | 3 | 5 | 5 | 3 | 8 | |
| | | | | | | 36 | 8 | 6 | 8 | 30 | 28 | 30 | 10 | 14 | 4 | 58 | |
| STND DATA: | ADJ PIECE: | SH: | LOT: | FZ: | | | | | | | | | | | | | |
| PIECES FOLLOW | SP | SH | LOT | CHG | FZ | TI | DF | QE | METHOD | AMMUNITION EXPENDED | | | | | | | |
| PIECES FIRE | INSTR | | | | | | | | FFE | | | | | | | | |
| MOF | | | | | | | | | | | | | | | | | |
| PLT ADJ #3 ① | | HE | XY | 4 | Q | | 3024 | 247 | ② 1/E | ① | | | | ① | ① | | |
| | | | | | | | 2978 | 218 | | ② | | | | ② | ② | | |
| PLT ② | | | | | | | 2950 | 210 | | ④ | | | | ④ | ④ | | |
| EOM | | / | | | | | | | | | | | | | | | |
| #3 and #4 ③ | | WP | DY | 7 | Q | | 2870 | 320 | | ③ | | | | ③ | ③ | | |
| EOM | | / | | | | | | | | | | | | | | | |
| #3 ① | | SMK | FY | 4 | TI | 19.6 | 2942 | 216 | | ① | | | | ① | | ① | |
| EOM | | / | | | | | | | | | | | | | | | |
| Transferred to Section #4 6 Rounds as Follows | | | | | | | | | | 4 | | | 2 | 6 | 4 | 2 | |
| Total | | | | | | | | | | 28 | 5 | 5 | 6 | 24 | 20 | 19 | |
| | | | | | | | | | | | | | | 10 | 11 | 4 | |
| | | | | | | | | | | | | | | | | 44 | |

Figure 7-4. Use of DA Form 4513 without standard data

b. Nonstandard FFE Mission. In this example, no standard elements are used:

FIRE MISSION, NUMBER 3 AND NUMBER 4, 3 ROUNDS, SHELL WP, LOT DY, CHARGE 7, FUZE QUICK, DEFLECTION 2870, QUADRANT 320.

Number 3 and Number 4 each fire three rounds as commanded. **END OF MISSION** is commanded as appropriate, and ammunition expended is updated (see Figure 7-4).

c. Standard Adjust-Fire Mission. Elements designated as standard in this example are Number 3 firing one round in adjustment, shell HE, lot XY, and fuze quick:

FIRE MISSION, PLATOON ADJUST, CHARGE 4, DEFLECTION 3024, QUADRANT 247, 2 ROUNDS IN EFFECT.

(1) Number 3 fires one round (shell HE, lot XY, fuze quick) with the announced charge, and at the announced deflection and quadrant. Nonadjusting pieces prepare two rounds of HE and follow commands. Adjustment continues as in the first example.

(2) When fire for effect is entered, the commands are:

PLATOON 2 ROUNDS, DEFLECTION 2950, QUADRANT 210.

(3) The entire platoon fires two rounds of shell HE at the announced deflection, and quadrant. **END OF MISSION** is commanded as appropriate.

Note: At **END OF MISSION**, an ammunition update is required as illustrated in Figure 7-5, page 7-10.

d. Standard FFE mission. Elements designated as standard in this example are Number 3, one round, shell HE, lot XY, and fuze quick.

FIRE MISSION, PLATOON 3 ROUNDS, CHARGE 4, DEFLECTION 3111, QUADRANT 400.

Each weapon in the platoon fires three rounds (shell HE, lot XY, fuze quick) with the announced charge, and at the announced deflection and quadrant. **END OF MISSION** is commanded as appropriate, and ammunition is updated (see Figure 7-5).

| RECORD OF MISSIONS FIRED | | | | SECTION | DATE | PAGE | OF | AMMUNITION/FUZES ON HAND | | | | | | | | | | | | |
|---|-------------|----|-----|-----------------|--------|---------|-------|--------------------------|---------------|---------------------------|---------------------------|----|----|---------------------------|---------------------------|---------------------------|---------------------------|---------------------------|---|----|
| For use of this form, see FM 6-50. The proponent agency is US Army Training and Doctrine Command. | | | | C-14/#4 | Today | 1 | | HE | WP | ^S _M | ^L _L | GB | WB | PD | TI | TI | VT | ^R _M | | |
| | | | | | | | | X | D | F | J | Q | Y | ³ ₉ | ⁵ ₈ | ⁵ ₇ | ³ ₂ | 82 | | |
| STND DATA: | | | | ADJ PIECE: #3 ① | SH: HE | LOT: XY | FZ: Q | | | | | | | | | | | | | |
| | | | | | | | | 36 | 8 | 6 | 8 | 30 | 28 | 30 | 10 | 14 | 4 | 58 | | |
| PIECES FOLLOW PIECES FIRE MOF | SP INSTR | SH | LOT | CHG | FZ | TI | DF | QE | METHOD FFE | AMMUNITION EXPENDED | | | | | | | | | | |
| PLT ADJ #3 ① | | | | 4 | | | 3024 | 247 | ② 1/E | 1 | | | | | 1 | 1 | | | 1 | |
| | | | | | | | 2978 | 218 | | 2 | | | | | 2 | 2 | | | 2 | |
| ② | | | | | | | 2950 | 210 | ② | | | | | | ② | ② | | | ② | |
| EOM | | | | | | | | | | 34 | 8 | 6 | 8 | 30 | 26 | 28 | 10 | 14 | 4 | 56 |
| PLT ③ | | | | 4 | | | 3111 | 400 | ③ | | | | | | ③ | ③ | | | ③ | |
| EOM | | | | | | | | | | 31 | 8 | 6 | 8 | 30 | 23 | 25 | 10 | 14 | 4 | 53 |
| #4 ② | | | | 4 | | | 3115 | 246 | ② | | | | | | ② | ② | | | ② | |
| EOM | | | | | | | | | | 29 | 8 | 6 | 8 | 30 | 21 | 23 | 10 | 14 | 4 | 51 |
| Resupplied by Section #3 as Follows | | | | | | | | | | 4 | | | | 2 | 6 | | 4 | | 2 | 6 |
| Total | | | | | | | | | | 33 | 8 | 6 | 10 | 36 | 21 | 27 | 10 | 16 | 4 | 57 |

Figure 7-5. Use of DA Form 4513 with standard data

7-25. RECORD OF MISSIONS FIRED

a. The DA Form 4513 or 4513-R is used by each section to record fire commands (digital or voice), ammunition stock (on hand, fired, transferred or resupplied), and any standardized data. After this form has been completed, it is used primarily for computing remaining tube life on the DA Form 2408-4. All elements, of this form must be recorded neatly and accurately.

Note: A reproducible copy of DA form 4513-R is located at the back of this manual.

b. The form consists of four basic parts. They are the administrative data (to include standard data), AMMUNITION/FUZES ON HAND, the fire mission data (to include transfer and resupply) and AMMUNITION EXPENDED. Each of these parts should have the following information recorded (see Figures 7-4 and 7-5):

(1) Administrative data

(a) SECTION-howitzer bumper number/position number in formation.

(b) DATE-date of firing.

(c) PAGE OF-each side of the form represents one page of the total pages for that days firing.

(d) STND DATA-elements of a fire command standardized in order to expedite the delivery of fires.

- ADJ PIECE-howitzer designated as adjusting piece (voice commands only) and number of rounds to be fired.
- SH-type of shell used in adjustment.
- LOT-designated lot of projectile and propellant. Lot designators are usually established by the platoon leader or fire direction officer.
- FZ-type of fuze used in adjustment.

(2) AMMUNITION/FUZES ON HAND

(a) On the first line, enter the type of ammunition.

(b) On the second line, list lot designators for projectiles, propellants, fuzes, and the primer nomenclature. Projectiles and propellants are recorded separately for separate-loading ammunition.

(c) On the third line, list the actual count of each.

(3) Fire mission data.

(a) Record fire command elements in this portion unless they are already standardized.

(b) Record resupply and transfer of ammunition.

(4) AMMUNITION EXPENDED

(a) In this column, record all ammunition expended or received.

(b) Circle each round shot in a fire mission, and record the cumulative count. Upon receipt of EOM, subtract total rounds fired (the last circled number in the column) from the initial or latest total.

(c) Entries for resupply and transfer of ammunition are not circled.

c. The DA Form 4513 or 4513-R should be turned in (usually to the GSG, platoon sergeant, or platoon leader) once every 24 hours for the purpose of updating the DA Form 2408-4. The unit SOP applies. The PAGE OF block is completed at this time. The form should be filled out completely to eliminate errors. The chief of section should check it periodically for neatness and accuracy,

Note: A cumulative count is kept to reduce errors in deriving totals. Once totals are derived, except those listed in the AMMUNITION/FUZES ON HAND block, they are represented by two slashes in the upper left-hand corner of the block being totaled. When a page is filled out in full, the totals placed in the AMMUNITION/FUZES ON HAND block on the next page are the last listed totals. At the end of a mission or upon resupply, the amounts of ammunition on hand are totaled on the appropriate line. Thus, a running count is continually maintained.

CHAPTER 8

SPECIAL SITUATIONS

8-1. DIRECT FIRE

Direct fire is a special technique that demands a high standard of training and requires the section to operate as an independent unit. It should be used only as a last resort. Considerations for direct fire engagements are discussed below.

a. Trajectory. Trajectory characteristics change with the range to target and charge fired. The following information is based on use of charge 7.

Note: To produce the highest muzzle velocity and a flat trajectory, the maximum charge should always be used for direct fire.

(1) 0 to 400 meters. This is the most accurate range at which to engage a target with direct fire during combat, because the trajectory is flattest.

(2) 400 to 1,500 meters. In this zone, the trajectory is flat enough to allow direct estimation of range without actual bracketing of the target. Range changes in 50-meter increments give the best results.

(3) 1,500 to 2,500 meters. Hits are only reasonably possible in this zone. The bracket method of adjusting will probably be required to obtain a hit.

(4) Over 2,500 meters. Direct fire is not effective.

b. Types of Targets. The most likely direct-fire targets are vehicles and/or dismounted personnel. Vehicles are engaged as point targets. Personnel are engaged as area targets. Direct-fire priorities should be as follows:

- Vehicles at short ranges threatening to overrun the position.
- Stationary vehicles covering the advance of other vehicles.
- Command and control vehicles.

c. Ammunition

(1) Shell/fuze combination used against armor and vehicular targets are as follows:

- 105mm— Shell high explosive plastic-tracer (HEP-T); shell HE with impact, mechanical time, or variable time fuzes set for superquick action; and

shell WP with impact or mechanical time fuze set for superquick action.

- 155mm— shell HE with impact, mechanical time, or variable time set for superquick action and shell WP with impact or mechanical time fuze set for superquick action.

Note: WP projectiles can be used effectively to ignite immobilized vehicles. Smoke and WP projectiles can be used to obstruct the vision of vehicle drivers and tank gunners and serve to disorient them.

(2) Shell/fuze combinations used against personnel are as follows:

- 105mm-antipersonnel (APERS-T) and shell HE with impact (set for delay action), mechanical time, or variable time fuzes (set for superquick action) fuze.
- 155mm-shell HE with impact (set for delay action), mechanical time or variable time fuzes (set for superquick action) fuze.

Note: When used against personnel, shell HE with impact fuze (delay action) is fired at a point 10 to 30 meters in front of the target to achieve the best effects.

8-2. DIRECT FIRE SIGHTING METHODS

The three primary methods of sighting used in direct fire are as follows:

a. Two-Man, Two-Sight. This method is best for all weapons except the 105-mm howitzer M119. The gunner establishes lead with the pantel, and the AG establishes elevation with the direct fire telescope. This is the fastest and most accurate method of sighting. It permits the AG to check the direction of lead. The reticle in the direct-fire telescope must be level. A canted reticle in the direct fire telescope will prevent satisfactory direct fire on moving targets because an unacceptable range error is introduced when lead is changed.

b. Two-Man, One-Sight. The gunner establishes lead with the pantel, and the assistant gunner sets elevation on the elevation quadrant at the command of the chief of section. This method is not effective when the target is moving on other than flat terrain.

c. **One-Man, One-Sight.** This method is least desirable and should not be used unless absolutely necessary. The gunner lays for lead and elevation with the reticle of the pantel. This method should not be used if the target is moving or on a steep slope.

8-3. DIRECT FIRE LAYING METHODS

The two primary methods of laying for direct fire are discussed below.

a. **Reticle Laying.** The gunner maintains lead by placing the vertical hairline the proper number of mils ahead of the point of aim on the target (Figure 8-1).

b. **Central Laying.** The gunner sets the lead in mils on the azimuth micrometer scale of the pantel and maintains the vertical hairline of the reticle on the center of the target (Figure 8-2). There is a modification on the knob of the M100-series pantel called a click sight. It permits the gunner to set off lead in 5-mil increments, by sound or feel, without removing his eye from the sight.

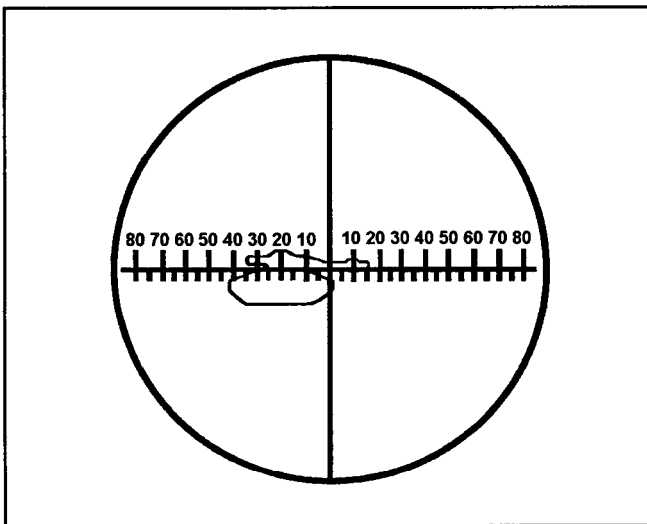

Figure 8-1. Gunner's sight picture, reticle laying (lead R20)

8-4. COMMANDS FOR DIRECT FIRE

a. The platoon leader/XO or BC will direct the engagement of targets by certain sections using verbal commands. Normally, individual section commands for direct fire are given by the howitzer section chief. The commands include the following:

- A warning order - **TARGET (so-and-so).**
- General direction to the target - **LEFT FRONT.**

- Lead in mils (how to determine lead is explained in the weapon manual) - **LEAD, RIGHT 5.**
- Range to **target-RANGE 800.**
- Method of **fire-FIRE AT WILL.**

b. The shell, fuze, and charge to be fired should be standardized to save time. If a shell-fuze combination other than the standard is desired, the command **SHELL (so-and-so)**, with time (if applicable), is given after the direction to target.

c. The howitzer section chief gives subsequent commands based on the observed effects.

(1) Change in lead. During adjustment, the lead in mils is changed to a new total lead command.

EXAMPLE

The initial fire command was **LEAD LEFT 5.** After spotting the burst, the section chief decides a lead of 10 will hit the target. His subsequent command is **LEAD LEFT 10.**

(2) Change in range. During adjustment, the range is increased by the command **ADD (so many meters)** and is decreased by the command **DROP (so many meters).** Another option is that the section chief announces a new range based on the desired increase or decrease in range to hit the target. Unit SOPs will dictate which technique to use.

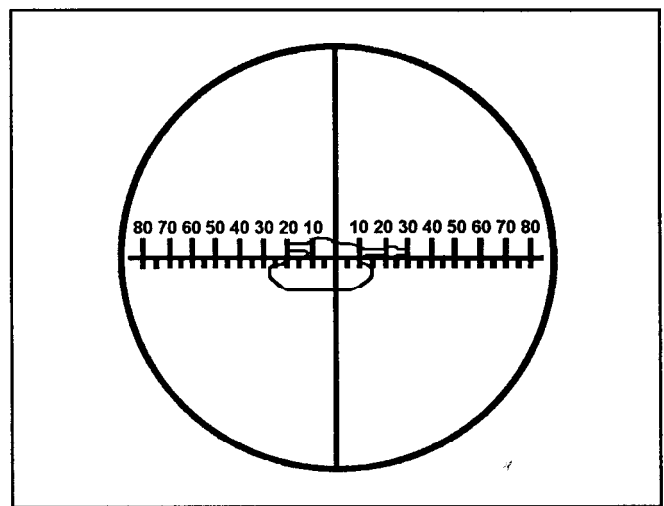

Figure 8-2. Gunner's sight picture, central laying (lead R20, deflection 3180)

d. When commands for direct fire are issued, firing battery personnel must ensure that direct-fire engagements do not result in fratricide. This is the particular responsibility of the howitzer crew, section chief, FDO, platoon leaders, and platoon sergeants in a platoon-based unit and of the XO, chief of tiring battery, and GSG in a battery-based unit. (See AR 385-63 on minimum engagement ranges.)

8-5. EMERGENCY BORESIGHTING

a. Boresighting is the only means a gunner has of ensuring that the optical axis of his sights are parallel to the tube of the weapon. The weapon should be boresighted in the following cases:

- Anytime the sight has been subjected to any shock other than tiring.
- Before firing in a new firing position (verify).
- Anytime the howitzer fires inaccurately for no apparent reason.

b. The primary methods of boresighting are:

- Distant aiming point.
- Test target.
- Standard angle.

c. When time is not critical and the tactical situation permits, use of the test target may be preferred over the DAP method because of its accuracy.

d. Boresighting methods are discussed in detail in the applicable weapon manuals. The following paragraphs describe several boresighting techniques that may be used if, for some reason, one of the primary methods is not possible.

8-6. COLLIMATOR METHOD OF BORESIGHTING

The collimator may be used to boresight weapons. Procedures are as follows:

- a. Prepare the weapon for boresighting in the same manner as for the DAP method.
- b. Place the collimator about 20 feet in front of the tube.
- c. Sight through the tube and align the 0 of the collimator with the vertical muzzle boresight string.
- d. With the pantel, sight on the collimator and match the numbers on the reticle pattern of the sight with the numbers on the collimator. The reading should be as follows:
 - 3200 on the azimuth scale of the M 100-series sight.

- 0 on the slip scale of the M12-series sight.

Note: This method may not work with the M109A31A6 or M198 howitzers. Because of the length of the tubes on these howitzers, the numbers in the collimator may not be visible during the alignment portion (paragraph c above) of the boresighting process.

8-7. STANDARD ANGLE METHOD OF BORESIGHTING

For the M101A1, the standard angle must be established during the conduct of a fire control alignment test. The procedures are outlined in the applicable weapon manuals. To boresight by the standard angle method, do the following:

- a. Establish the recoiling parts in the same relationship to the nonrecoiling parts as they were when the standard angle was established.
- b. Place a pin in the left witness mark on the muzzle.
- c. Install the parallax shield.
- d. Set the standard deflection angle on the telescope.
- e. Using a tested gunner's quadrant, set the standard elevation angle.
- f. Match all standard angle scribe lines.
- g. If the weapon is out of boresight, do not disturb the bubbles. Adjust the vertical hairline onto the junction of the pin and the muzzle.

Note: As soon as possible, the boresight should be verified by a more accurate means.

8-8. AIMING CIRCLE METHOD OF BORESIGHTING

- a. Set up the aiming circle approximately 30 to 50 meters in front of the weapon (Figure 8-3, page 8-4).
- b. Insert the boresight disks and strings in the cannon.
- c. With the **upper** motion of the aiming circle, set off 0000 (for M12-series sights) or 3200 (M100-series sights).
- d. Align the cannon bore on the aiming circle, and center the cross-level bubble of the pantel.
- e. With the **lower** motion of the aiming circle, align the vertical hairline on the center of the cannon bore.

f. With the **upper** motion of the aiming circle, align the vertical hairline on the pantel of the weapon. Read the instrument reading (angle from center bore to pantel) to the weapon.

g. The gunner sets the announced reading on the pantel. He then adjusts the pantel by using the tangent screws, or the boresight adjustment shaft, until his sight picture is centered on the lens of the aiming circle.

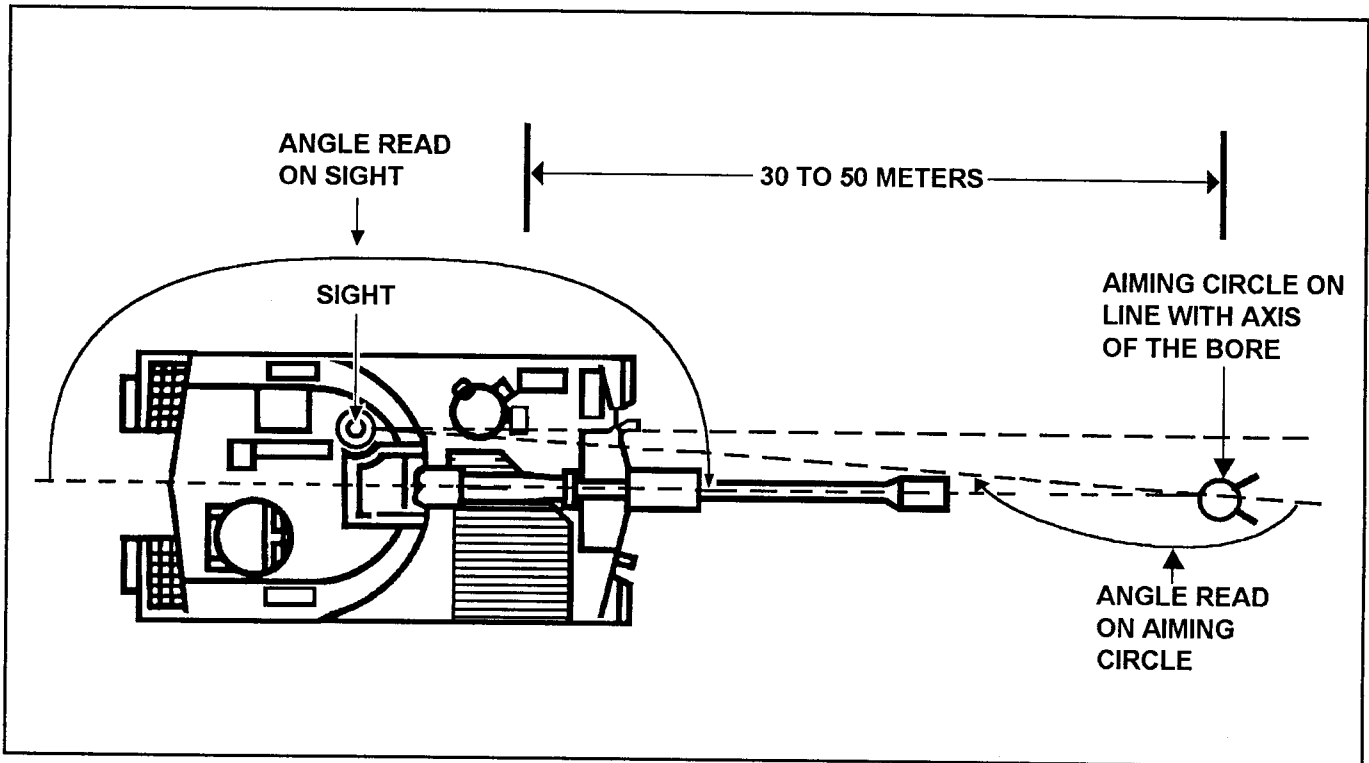

Figure 8-3. Aligning the sight parallel to the axis of the bore by use of an aiming circle

CHAPTER 9

COMMUNICATIONS

9-1. COMMUNICATIONS EQUIPMENT

The cannon battery or platoon uses both radio and wire equipment. Either system will become primary or secondary, depending on the tactical situation and the availability of equipment. There are advantages and disadvantages associated with each. For example, radio permits mobility and speed but is susceptible to enemy electronic warfare (EW). Wire lines are more immune to enemy EW, but they inhibit rapid movement and speedy installation. Hence, the strength of one becomes the weakness of the other. Therefore, it is reasonable to view the battery or platoon communications (comm) system as that which makes the best use of the radio and wire resources available at any given time. We must always strive to have a system redundant to the one being used, be it radio or wire. Ideally, it would be best to rely first on radio during displacements and initial site occupations. Then, if time permits, install and operate on wire lines. If radios are unavailable, or unusable, a wire system is necessary. Accordingly, the diagrams and system configurations which follow provide practical and realistic ways of establishing battery commo systems, depending on which TOE a unit uses.

9-2. BATTERY COMMUNICATIONS SECTION

a. To help the battery commander meet communications requirements, a comm section is authorized at the battery level. This section gives battery personnel technical assistance in the installation, operation, and maintenance of the battery comm system. Battery personnel share responsibility for installing, operating, and maintaining the battery comm system.

b. The battery comm chief advises the commander on communications matters. The two wiremen help install and maintain the intrabattery wire system and wire equipment. The comm chief's specific responsibilities are as follows:

(1) Provide communications training to battery personnel and technical assistance for communications training in the unit.

(2) Advise the BC on communications considerations during selection of positions.

(3) Supervise the maintenance of comm equipment in the battery.

(4) Coordinate with the battalion comm chief on matters of personnel, communications security (COMSEC) materials, equipment, parts, maintenance support, and communications training.

9-3. BATTERY WIRE SYSTEM

a. Presently, the FA battery or platoon relies on wire to meet its internal communications needs. Three DR-8s are issued to each howitzer section so the battery can have a separate voice, digital, and advance party capabilities.

b. There are changes to the wire terminals used in the battery wire system. The SB-16 is no longer recommended for digital communications. The terminal strip TM-184 provides a cleaner, more reliable digital signal. The TM-184 (NSN 5940-00-238-8493) is a class IX item and can be procured through the unit supply system. Four TM-184s will be required to install the battery or platoon wire system. One will serve as the voice wirehead, one as the digital wirehead, and one for an advance party capability. The fourth connects battalion wire lines. Two additional TM-184s are required for the second platoon in a platoon-based battery.

(1) Advance party. The advance party wire system (Figure 9-1) provides immediate voice communication upon arrival of the main body, between each howitzer, the aiming circle, and the FDC.

(a) When the advance party arrives at a new location, a designated platoon representative places a voice wirehead (TM-184) in the position area, usually near the platoon center behind the gun line. This will allow personnel to troubleshoot most of the wire system from behind the gun line.

(b) Using a DR-8 (¼-mile reel), the gun guides connect the running end of each wire line to the appropriate pair of line binding posts on the voice wirehead. After this connection is made, the wire lines are tied off to a stake next to the voice wirehead and are tagged. Each gun guide then routes the wire from the voice wirehead to his gun position and connects it to the line binding posts on his telephone set TA-312 or headset-chestset, sound powered H-200. It is advisable to route wire lines to a stake forward of the gun line, as illustrated in Figure 9-1, to avoid wire line damage by vehicles moving in with the main body. **However, the chosen wire line route will be dictated by terrain and available wire.**

(c) The FDC representative also installs a wire line from the voice wirehead to the FDC position by using a DR-8. The running end of the wire line is connected to the appropriate pair of binding posts on the voice wirehead and tied off to a nearby stake and tagged. The wire line is then routed to the vicinity of where the FDC will be positioned and is connected to a TA-312, H-200, or an AN/GRA-39.

(d) To complete the voice wire system, a battery or platoon representative installs a wire line to the aiming circle from the voice wirehead. After this circuit is completed by installation of a telephone set TA-312, or H-200, the telephone system will allow the howitzers to be laid when the main body occupies the firing position.

(2) Main body occupation. Soon after the main body is in position, a second wire system is installed for digital communications.

(a) A second TM-184 (digital wirehead) is also placed near the battery or platoon center behind the gun line. The procedure for installing this system is identical to that used by the advance party, except the wireline is connected to the GDU at the howitzer and to the BCS in the FDC (Figure 9-2). In the howitzer, the wire line is connected to the BCS binding posts (labeled BCU) of the case assembly (Figure 9-3). The wire line at the FDC is routed into the vehicle and connected to the wire line adapter of the BCS (Figure 9-4, page 9-4). Stakes should be used at the howitzer and the FDC to secure incoming wire lines

to reduce damage to the wire system by moving vehicles and personnel. Again, if terrain and available wire permit, the digital system should be routed to the front of the gun line to minimize system damage.

CAUTION

Avoid any ringing-type comm device on the digital line, as they have the potential to destroy the GDU case assembly.

(3) Complete system. If time and assets permit, a wire line can be installed as necessary between the BCS of the two platoon FDCs by using an RL-27 and RL-159 (Figure 9-5, page 9-5). This wire line can be used as necessary to hand off digital fire missions between FDCs. As time and mission allow, SB-22 switchboards can be installed in each platoon and connected by wire line to a battery command switchboard (SB-22) providing voice communications. In battery based operations (Figure 9-6, page 9-6), only a battery command switchboard is installed. Additional voice or digital capability can be provided by a battery wirehead that interfaces with battalion voice and digital wire lines. In most cases, external communications rely primarily on radio communications (and mobile subscriber equipment). The extent to which wire is installed and lines are improved or protected depends on the anticipated time the firing unit will stay in position before moving again.

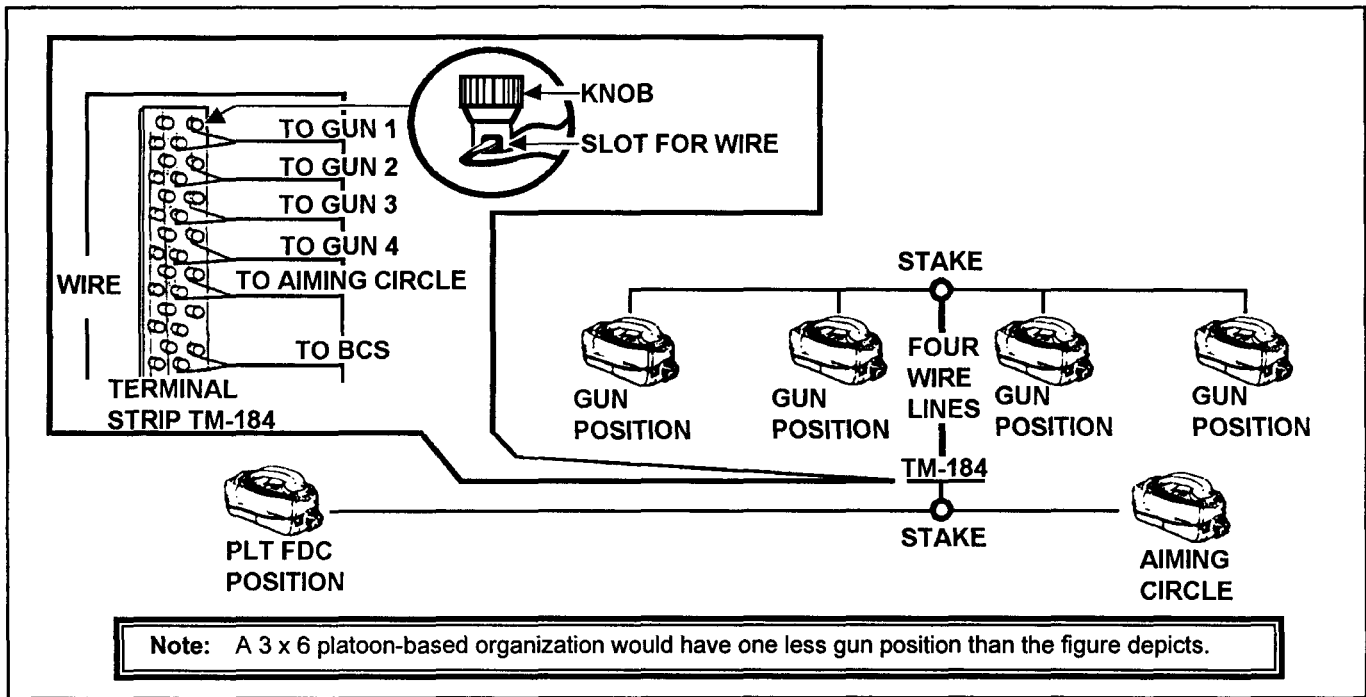

Figure 9-1. Advance party voice wire system (one of two platoons)

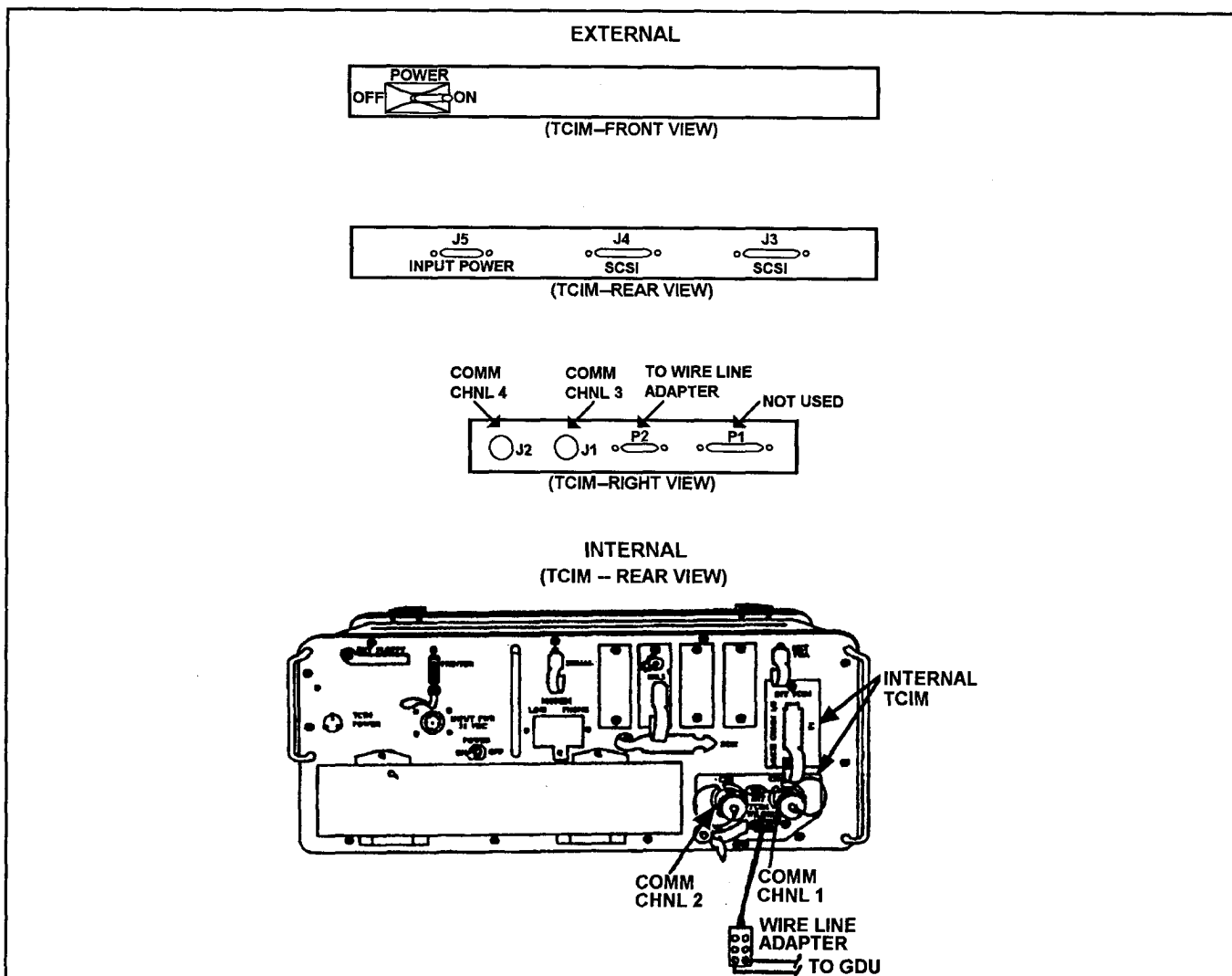

Figure 9-4. Wire and radio connections to the LCU

c. All wire lines should be identified by tagging them individually at each end as outlined in TC 24-20 and at each stake. This facilitates troubleshooting the wire system. Wire tags should be prepared and labeled in accordance with the unit signal operating instructions (SO1) and SOP.

9-4. BATTERY RADIO NET STRUCTURE

The firing battery in a direct support (DS) battalion operates in two external radio nets and one internal radio net. Figure 9-7, page 9-7, shows the battery (btry) radio net structure. Listed below are the radio nets in which the battery operates and a description of how each net is used.

a. Battalion Command (Cmd) Net (FM-Voice). This is a secure net used for command and control and for intelligence information. The battalion (bn) operations and intelligence

(O&I) element is the net control station (NCS). The battery commander, first sergeant, platoon leaders, platoon sergeants, platoon FDCs and the ammunition sections operate in this net.

b. Battalion Fire Direction Nets (FB1, FD2, FD3) (FM-Digital). These are tactical fire direction (FD) nets that are assigned one to each firing battery. The Bn FDC is the NCS for these nets. The assigned net (FD1, FD2, or FD3) is used to pass digital traffic. It may be converted to a voice net to fit operational needs. Each platoon FDC operates in this net and communicates digitally with the battalion FDC by using the BCS. The platoon FDC can also use this net as directed to communicate with the company fire support headquarters, forward observers, battalion fire support section, combat observation/lasing teams, aerial observers, and Firefinder radar sections.

Note:

1. TA-312s can be substituted for SB-22s if no other administrative lines are installed in the battery or platoon area.
2. The digital line can be routed directly between the two FDCs if the battery wirehead is not installed.
3. A 3 x 6 platoon-based organization would have one less howitzer than the figure depicts.

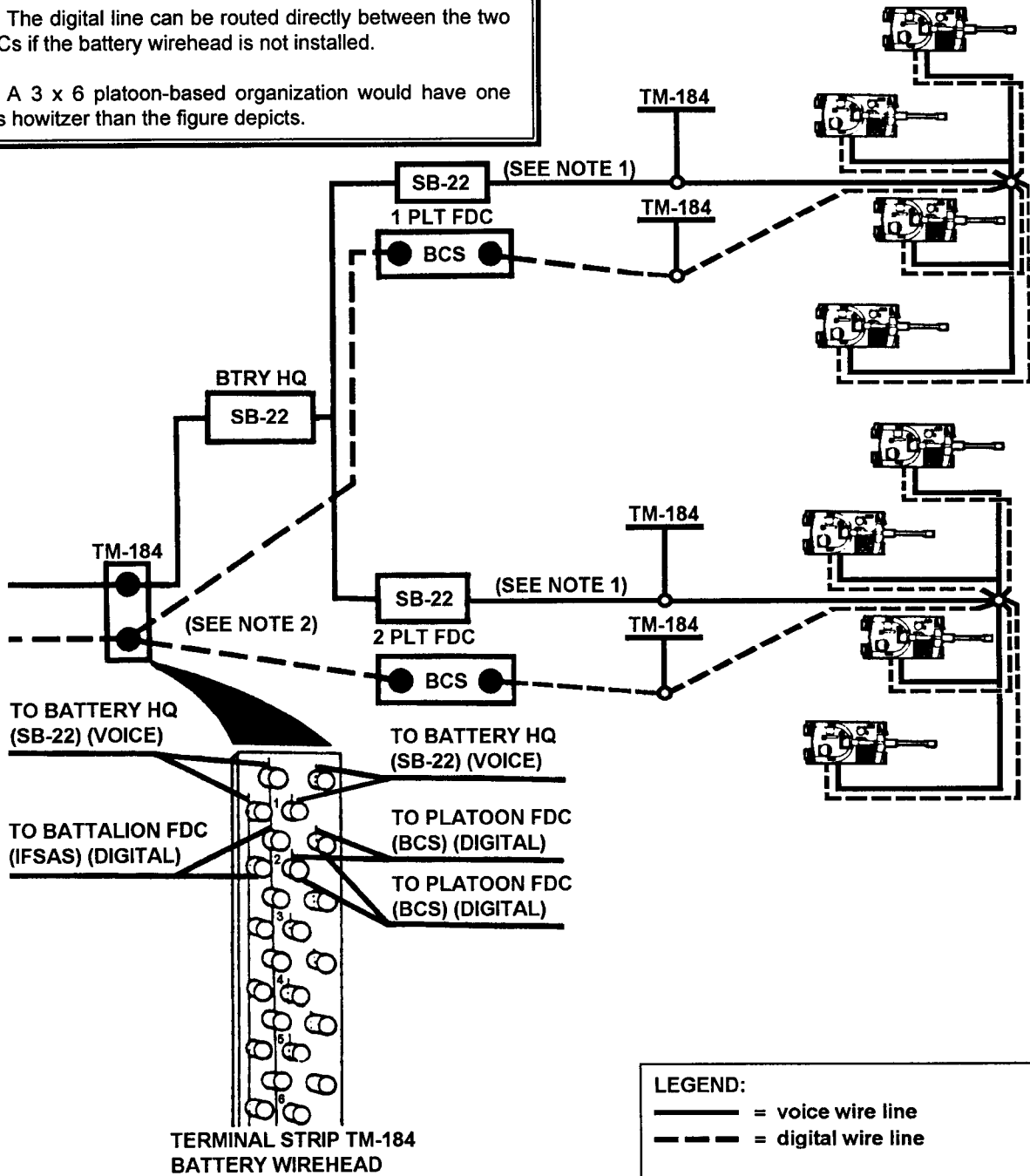

Figure 9-5. Platoon-based battery wire system

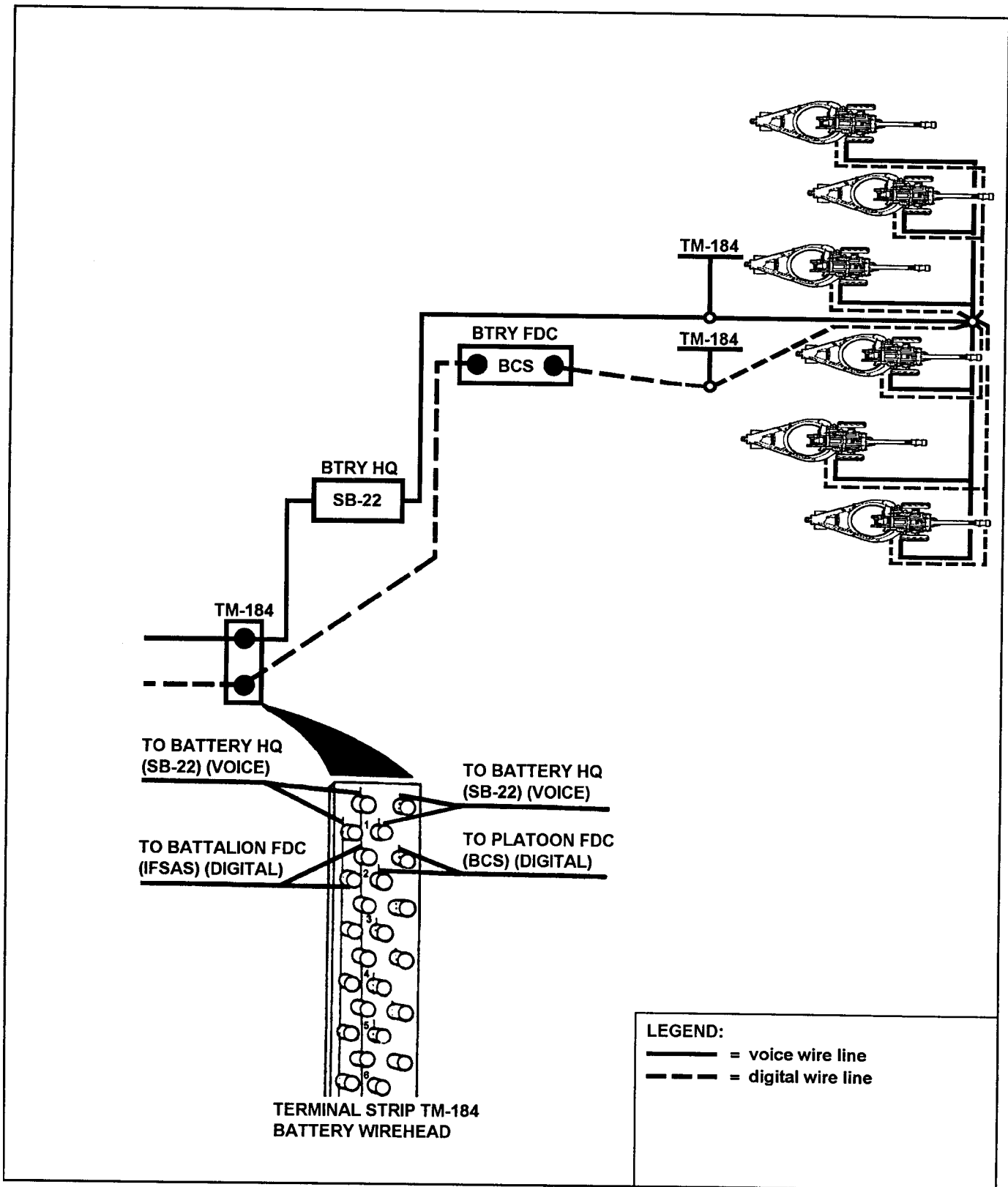

Figure 9-6. Battery-based battery wire system

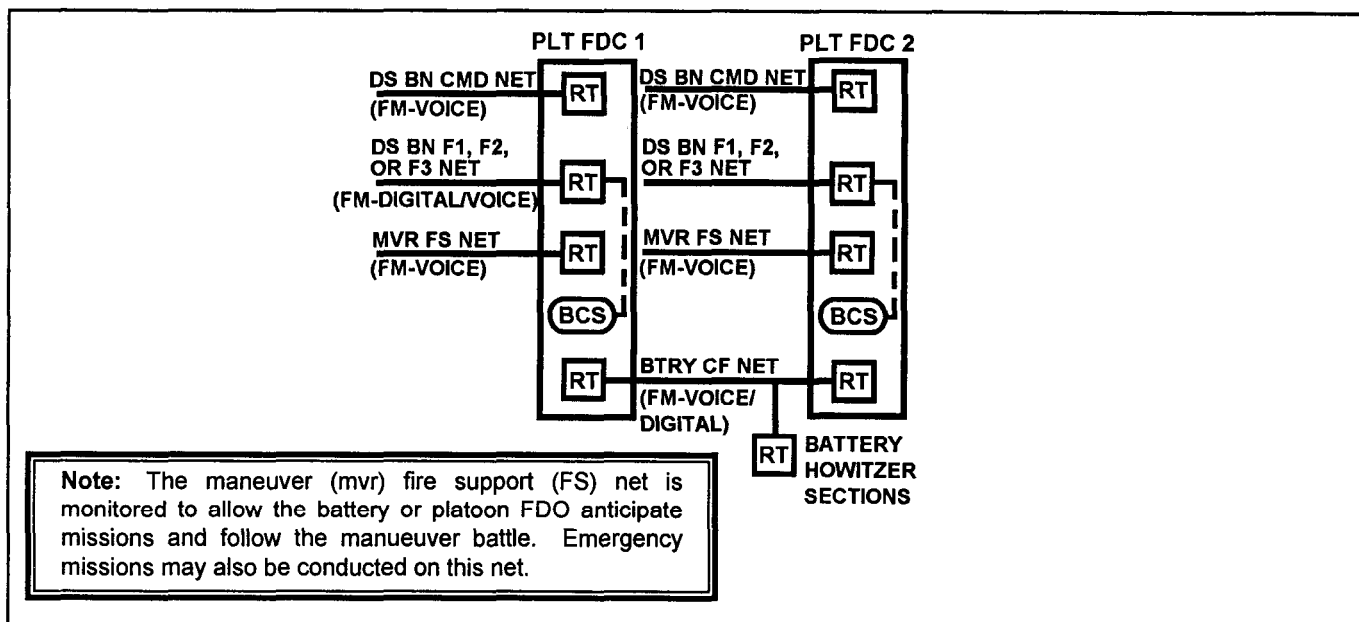

Figure 9-7. Battery radio nets

c. Battery Command/Fire (CF) Net (FM-Voice and/or Digital). With the fielding of the small unit transceiver (SUT) AN/PRC-68 or AN/PRC-126 and the radio set single channel-ground and airborne radio system (SINCGARS), each FA firing battery will have its own internal radio net.

(1) The L-edition TOE authorizes two AN/PRC-68s or AN/PRC-126s per howitzer section (one in the howitzer and one in the ammunition resupply vehicle, one per FDC, one per platoon leader, and one for the battery commander.

(2) The AN/PRC-68 or AN/PRC-126 can receive operating power from either the battery source or from a vehicular power system. In the hand-held mode, the AN/PRC-68 or AN/PRC-126 is powered by a 15.4 volt dry battery (BA-1588) that provides 24 hours of continuous operation. To operate the AN/PRC-68 or AN/PRC-126 with vehicular power, an amplifier-power supply OG-174 is required. The OG-174 allows the AN/PRC-68 or AN/PRC-126 to be mounted inside a vehicle, interfacing with the vehicle intercom. It provides an external antenna (Figure 9-8).

(3) Once the AN/PRC-68s or AN/PRC-126s are connected to the BCS and GDUs in the FDC and howitzers, respectively, the Battery CF Net can be used to pass digital traffic between the FDC and the howitzer sections. Once quality digital communications is established, voice communications should be discontinued and all headsets may be removed.

9-5. AN/PRC-68 AND AN/PRC-126 PLANNING CONSIDERATIONS

The AN/PRC-68 or AN/PRC-126 can be employed in a variety of tactical applications. However, limitations sometimes make it less than ideal. Therefore, wire communications should always be established if logistics, time, and tactical constraints permit. The AN/PRC-68 or AN/PRC-126 with OG-174 gives the FA cannon battery or platoon the capability to transmit digital as well as voice communications internally. Without the OG-174, the PRC-68 or AN/PRC-126 is used routinely for voice communications only in the hand-held mode. The following planning considerations are provided for use of the SUT:

a. The battery comm chief can set the AN/PRC-68 or AN/PRC-126 internally on one base frequency. Any frequency change will be a time-consuming process. Therefore, units should request a fixed, sole user frequency to be included in the SOI for the battery CF net.

b. The use of the AN/PRC-68 or AN/PRC-126 may need to be tailored to a particular mission. Their use during convoys, ammunition resupply, hip shoots, and advance party and main body operations may warrant a change in assignment of these radios.

c. Radio-electronic combat may preclude the use of the radio because of jamming.

d. Mutual interference between friendly units may preclude use of the radio.

e. Alternate frequencies to be used in case of jamming must be identified.

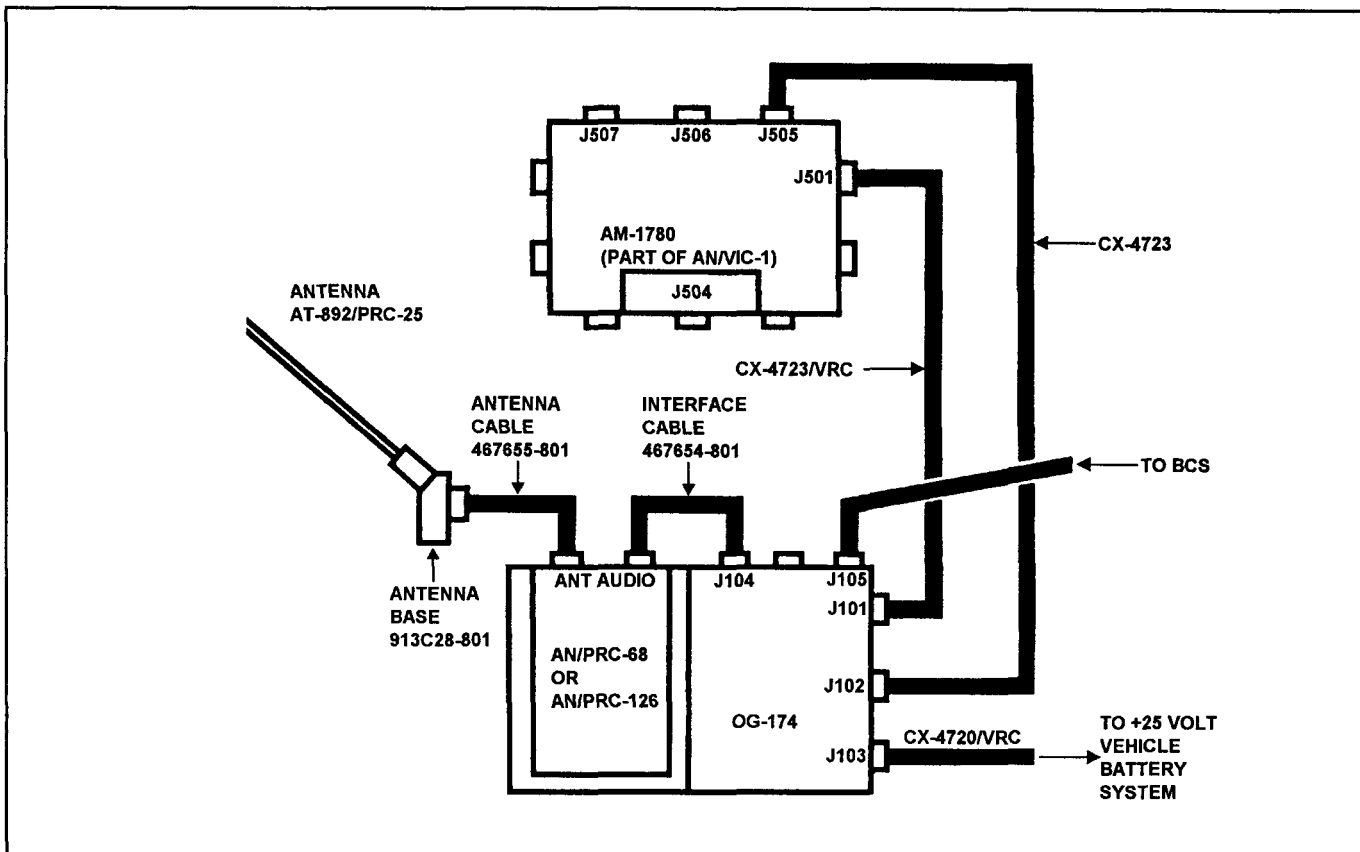

Figure 9-8. Amplifier-power supply OG-174 and small-unit transceiver AN/PRC-68 or AN/PRC-126

9-6. BCS-TO-GDU COMMUNICATIONS

The BCS-to-GDU link is the location of the most frequent problems. This area requires constant command attention if the maximum benefit is to be derived from the entire system. The following are the most common errors reported by or recommendations received from units worldwide:

a. BCS-GDU Wire Connection.

- (1) Wire must be **perfect**.
- (2) There must be a dedicated GDU wire with no splices.
- (3) WD-1 was never meant for digital communications. One improper splice or one short may knock the entire system out. (Acquire copper wire WF 16U, NSN 6145-00-910-8847, for use with the GDUs.)

b. Gun Assemblies for Deflection and Quadrant. There must be enough slack in wire lines for shifting trails. Otherwise, wires or assemblies may be damaged.

c. Grounding.

(1) The case assembly on a howitzer must be properly grounded according to TM specifications. Otherwise, the

system will malfunction, especially in wet weather or in early-morning dew.

(2) All wires and cables must be installed according to exact TM specifications.

d. Switchboard Use. Do not use an SB-22 or a similar device that requires a male end metal connector. Use a TM-184 or TM-125 type of terminal device.

e. GDU Power for Towed Unit. For GDU power, use a plug-in device to connect with the prime mover. Do not use a clamp connector to the vehicle battery since this will damage or destroy batteries and/or the GDU.

f. Mounts. All locally fabricated mounts should be inspected by comm technicians for proper power hookup and grounding.

g. Wire Setup Within the Position.

(1) A loop wire system from BCS to GDUs **does not work**. The vast and continuous amount of traffic in the system causes a loop to overload and malfunction or the guns will receive improper data.

(2) Failure to waterproof lines at the point of connection may cause loss of digital communications in wet weather. The plug-in terminal strip for GDU lines can be permanently mounted in a waterproof ammunition can with a hole drilled in the bottom for the lines to pass through. Once the lines are connected, the lid can be closed.

(3) The terminal strip should be centrally located so that each weapon uses no more than 400 meters of wire (one DR-8).

(4) Units must use a precise track plan and closely supervise movement of ammunition resupply vehicles to prevent damage or destruction of wire. Repair by splicing is unacceptable.

(5) Special positioning considerations for a platoon-based battery using one BCS is in Figure 9-9.

(6) Two wire lines must go to each gun—one voice and one digital. TA-312s should not be hooked up on the digital line once digital traffic begins.

h. NICAD Batteries. Nickel-cadmium (NICAD) batteries used in the GDU must be completely discharged before they are recharged. These batteries have a memory; unless they are discharged, they ultimately refuse to accept a recharge.

i. Digital Fire Commands. The section chief must view the entire digital fire command on every round. If in a hurry, he may see only charge, deflection, and quadrant. This creates obvious problems when FFE is entered or when shell, fuze, and/or fuze setting is changed.

j. Training. Observer, FDC, and howitzer section personnel must frequently participate in digital fire request loop training to get the maximum benefit from the BCS. The training set, fire observation (TSFO) is a tool which aids in this training.

k. AN/PRC-68 or AN/PRC-126 and GDU. The AN/PRC-68 or AN/PRC-126 (or other VHF-FM radio) can be connected to the case assembly, thus dispensing with wire to the GDU. Cables W33 or W34 are used for the signal, and W34 or W34A are used for power. (See TM 11-7440-283-12-2 and paragraphs 9-4 and 9-5 of this publication.)

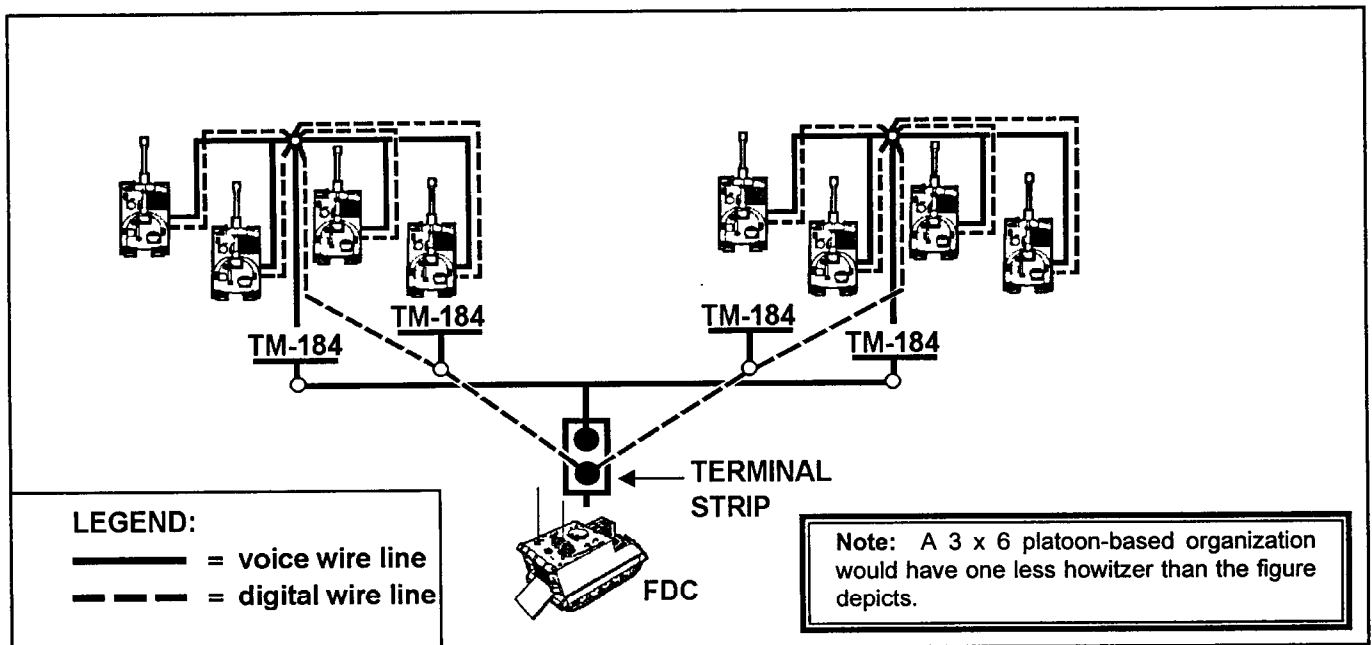

Figure 9-9. Positioning for platoon-based battery using one BCS

CHAPTER 10 AMMUNITION

10-1. REFERENCES

The combination of current and developmental ammunition with that being developed makes it essential that battery supervisors keep current on the latest changes. The following references will help them:

- a. TM 9-1300-251-20, Table 3-2, gives detailed information on ammunition component inspection criteria. Chapter 3 explains how to correct any deficiencies noted. Appendix M indicates what maintenance the crew and ammunition sections are authorized to perform.
- b. TM 43-0001-28 gives detailed characteristics of primers, projectiles, propellants, and fuzes. It includes combination and compatibility charts for all artillery weapons and ammunition components.
- c. TM 9-1300-206 gives detailed information on complete precautions for handling artillery ammunition.
- d. The operator's manual for the weapon system gives information on the ammunition authorized for use with that system.
- e. Appendix M to this publication outlines characteristics of FA cannons, and Appendix N discusses interchangeability of ammunition for those weapons.

10-2. EXTERIOR COMPONENTS OF AN ARTILLERY PROJECTILE

Since the first projectile was manufactured, the demand for greater accuracy and greater range has influenced projectile design. Without specifically constructed shapes and exterior parts, there would be no standard ballistic characteristics for any group or type of projectiles. A lack of ballistic standardization would prevent the computation of firing tables. Modern projectiles are designed for maximum stability and minimum air resistance in flight. The exterior components of an artillery projectile are shown in Figure 10-1 and explained below.

a. Eyebolt Lifting Plugs and Fuze Well Plugs. A separate-loading projectile has an eyebolt lifting plug. Other types of projectiles have metal hex-head or plastic closing plugs. The plug is for lifting; to keep the fuze well clean, dry, and free of foreign matter; and to protect the fuze well threads. The plug is removed, and the appropriate fuze is inserted at the firing position. Some special-purpose semifixed projectiles are issued with the fuzes already assembled in the projectile.

b. Ogive. The ogive is the curved portion of a projectile between the fuze well and the bourrelet. It streamlines the forward portion of the projectile. The curve of the ogive usually is the arc of the circle, the center of which is located in a line perpendicular to the axis of the projectile and the radius of which is generally 6 to 11 calibers.

c. Bourrelet. The bourrelet is an accurately machined surface that is slightly larger than the body and located immediately to the rear of the ogive. It centers the forward part of the projectile in the tube and bears on the lands of the tube. When the projectile travels through the bore, only the bourrelet and the rotating band of the projectile bear on the lands of the tube.

d. Body. The body is the cylindrical portion of the projectile between the bourrelet and the rotating band. It is machined to a smaller diameter than the bourrelet to reduce the projectile surface in contact with the lands of the bore. The body contains most of the projectile filler.

e. Rotating Band. The rotating band is a cylindrical ring of comparatively soft metal that is pressed into a knurled, or roughened, groove near the base of the projectile. It mates with the forcing cone of the tube to eliminate gas wash (blow-by) and to provide forward obturation. The rotating band, in conjunction with the rifling of the tube, imparts spin to the moving projectile. A properly rammed separate-loading projectile is held in the tube at all angles of elevation by the wedging action of the rotating band against the forcing cone.

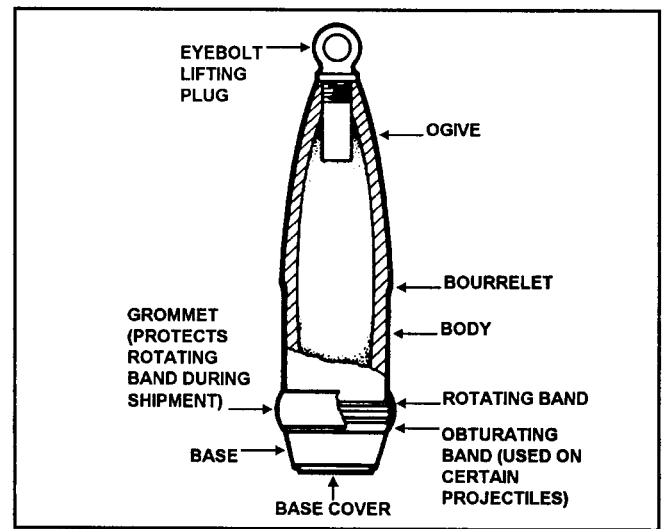

Figure 10-1. Exterior components

f. Obturating Band. On some projectiles, there is a nylon obturating band below the rotating band to help in forward obturation. Two examples of 155-mm projectiles with this type of a band are the illuminating round and the high-explosive rocket-assisted round.

g. Base. The base is that portion of the projectile below the rotating band or obturating band. The most common type is known as the boattail base. This type of base streamlines the base of the projectile, gives added stability in flight, and minimizes deceleration by reducing the vacuum-forming eddy currents in the wake of the projectile as it passes through the atmosphere.

h. Base Cover. The base cover is a metal cover that is crimped, caulked or welded to the base of the projectile. It prevents hot gases of the propelling charge from coming in contact with the explosive filler of the projectile through possible flaws in the metal of the base.

10-3. PROJECTILE PAINTING AND MARKING

The main reason for painting a projectile is to prevent rust. However, painting is also used to identify the various types of ammunition.

a. Identification. The basic colors used for many years were olive drab (OD) for high-explosive rounds, gray for chemical rounds, blue for practice rounds, and black for drill rounds. A system of contrasting color markings or bands in addition to the basic color has also been used to identify the particular type of high explosive or chemical used as a filler. Color coding of recently produced projectiles is somewhat different. For example, illuminating and smoke rounds are no longer painted gray, the basic color for chemical shells. Illuminating rounds are now painted basically white or olive drab, and the smoke rounds are painted green. The basic color for dummy ammunition has been changed to bronze.



b. Weight. Variations in weight are inherent in the manufacture of projectiles. Since a high degree of accuracy is required in artillery firing, one must compare the data stenciled on the projectile (Figure 10-2) with the data provided in the firing tables to obtain the proper ballistic corrections. The weight zone marking symbols for projectiles are shown in Table 10-1.

c. Ammunition Lot Number. When ammunition is manufactured, an ammunition lot number is assigned in accordance with pertinent specifications. This lot number is an essential part of the ammunition marking. When the size of the item permits, this lot number is stamped or marked on the item itself and on all packing containers. The lot

number is required for all records, including reports on the ammunition condition and functioning and on any accidents in which the ammunition is involved. To ensure uniform functioning, all the components in any one lot are manufactured under conditions as nearly identical as practicable. When semifixed ammunition is fired, successive rounds should be of the same lot number so that maximum accuracy is obtained. When separate-loading ammunition is fired, successive rounds should consist of projectiles of the same lot number, propelling charges of the same lot number, fuzes of the same lot number, and primers of the same lot number.

d. National Stock Numbers and Department of Defense Ammunition Code. National stock numbers (for example, NSN 1320-00-529-7331) have replaced the old Federal stock numbers (FSNs), the old ammunition identification codes (AIC), and ordnance stock numbers. Each item of supply has a different national stock number. The first four digits of a national stock number are always the Federal supply classification (FSC) to which the item belongs. The next two digits identify the country of origin. Continental United States, for example, uses 00 and 01. Some of the other NATO countries use their assigned digits, such as 12 for Germany, 15 for Italy, and 21 for Canada to mention just a few. The next seven digits constitute the national item identification number (NIIN). The dash between the third and fourth digits of the NIIN serves to reduce errors in transmitting. Each item has a different NIIN. A Department of Defense identification code (DODIC) is added as a suffix to the national stock number; for example, 1320-00-529-7331 (D544). The Department of Defense ammunition code (DODAC) is made up of eight characters—the four-character FSC code number and the DODIC. For example, 1320-D544, a typical DODAC, consists of FSC class 1320 and DODIC D544, which identifies a 155-mm HE projectile M107, and the NSN 1320-00-529-7331 indicates that the projectiles are packed eight per wooden pallet. The same DODIC suffixed to more than one NSN indicates items that are interchangeable. (See Appendix N.)

Table 10-1. Weight zone marking

| CALIBER OF PROJECTILE | WEIGHT ZONE | SYMBOL |
|-----------------------|-------------|---|
| 105 mm | 2 squares |  |
| 155 mm | 3 squares |  |

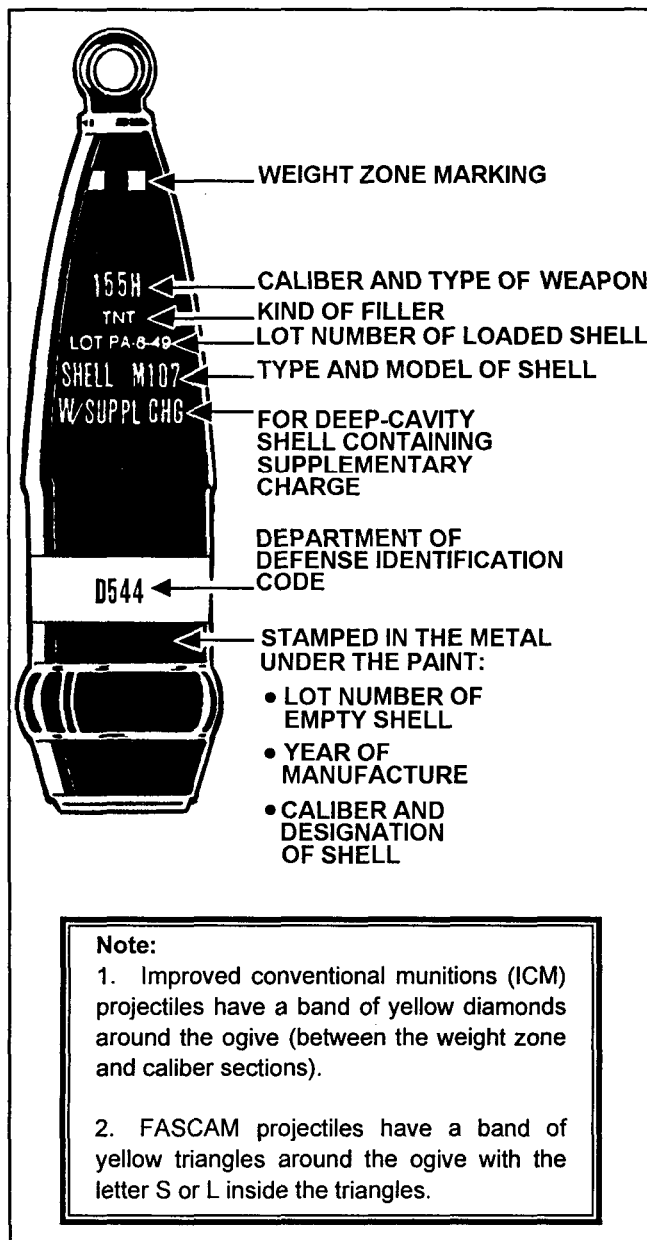

Figure 10-2. Markings of a (separate-loading) projectile

10-4. CARE AND HANDLING OF AMMUNITION

a. If ammunition is to function properly, it must be handled properly. Some of the basic principles of proper handling are listed below:

(1) Never tumble, drag, throw, or drop individual projectiles or boxes of projectiles.

(2) Do not allow smoking, open flames, or other fire hazards around ammunition storage areas.

(3) Inspect each round before it is loaded for firing. Dirty ammunition can damage the weapon, cause the breech not to close, or affect the accuracy of the round.

(4) Keep the ammunition dry and cool.

(5) Never make unauthorized alterations or mix components of one lot with another.

(6) If a round has been rammed and then must be extracted, return it to the battalion ammunition section. The rotating band or the fuze may be damaged and should not be fired.

(7) Leave the eyebolt lifting plug or closing plug screwed into the fuze well until the round is to be fuzed.

b. Care and handling of projectiles, fuzes, propelling charges, flash reducers, primers, and cartridge cases are discussed in paragraphs 10-5 through 10-10.

10-5. PROJECTILES

a. Projectiles must be inspected to ensure the following conditions:

(1) There is no leakage of the contents.

(2) The projectile is correctly assembled.

(3) The rotating band is in proper condition. If the rotating band is stained or discolored, that minor deficiency can be removed with fine sandpaper or steel wool. Projectiles with rotating bands which have minor dents or cuts can be fired. However, if dents or cuts go through the band, the round should be rejected by the using unit. The grommets must be secured and tight to prevent nicks and scarring of the rotating band or obturation band.

b. Most HE projectiles issued for use with proximity VT fuzes are standard projectiles with deep fuze cavities to accommodate the longer VT fuze. Each of these projectiles is issued with a removable supplementary charge so that the projectile may be used with an impact, a mechanical time or a long intrusion (VT) fuze. The supplementary charge is removed only when the projectile is used with a long intrusion VT fuze. It must be in place when the projectile is used with a mechanical time fuze, impact fuze, or short intrusion VT fuze.

CAUTION

Do not try to remove the supplementary charge by any means other than the lifting loop. If the charge cannot be removed by the lifting loop, the round may be disposed of or fired with an impact or an MTSQ fuze. The deep cavity maybe lined with a paper tube and bottom cup, which help support the high-explosive filler. This lining should not be removed at any time.

c. Because of their contents, toxic chemical and the WP shells require special handling and storage.

(1) Chemical rounds.

(a) When toxic chemicals are being fired, all personnel in the area should wear protective masks and anyone handling the shell should wear gloves.

(b) An ample supply of decontaminating agents should be available in case they are needed.

(c) If possible, these shells should be stored away from other types of ammunition and downwind of the battery area.

(2) White phosphorus. WP rounds (except for the M825 and M825A1) should be stored upright on their base at all times. The filler of these rounds will melt at a temperature of 111.4°F. As a result, the filler shifts and the ballistic characteristics of the rounds change. The WP shell should be in an area free of any combustible materials and away from other ammunition if possible. (This also applies to the M825 projectiles.)

10-6. FUZES

a. The specific fuzes available for each weapon are discussed in the technical manual for the weapon.

b. Fuzes are sensitive to shock and must be handled with care.

c. Before fuzing a round, inspect the threads of the fuze and fuze well for cleanliness and serviceability.

d. The fuze should be screwed into the fuze well slowly until flush with the nose of the projectile. Using the M16 or M18 fuze wrench (as appropriate), back the fuze up one-quarter turn, then snap the fuze wrench back to secure the fuze.

e. After tightening the fuze, ensure that there is no gap between the nose of the projectile and the fuze. If a gap exists, remove the fuze from the projectile and segregate both from the ammunition. Premature detonation may occur if a fuze is not properly seated.

f. A projectile fuzed with a time fuze should not be lifted with a hand around the fuze. A slip of the hand might change the fuze setting.

g. Normally, fuzes containing superquick elements should not be used during rainstorms or hailstorms. They may detonate if struck by rain or hail. However, a new rain insensitive fuze, M739A1, has been developed and is available to be fired through storms with reduced possibility of premature functioning.

Note: Units must be aware of the ammunition restrictions that apply to their caliber of weapons. Restrictions are in the technical manual for the weapon.

h. To prevent the accidental functioning of the point-detonating elements of fuzes M564 and M548, the fuzes must not be dropped, rolled, or struck under any circumstances. Special care must be taken to ensure that a fuzed round does not strike the breech of a weapon during loading.

i. Any mechanical time fuze that is set and not fired must be reset to SAFE; and the safety wires (if applicable) must be replaced before the fuze is repacked in the original carton.

Note: Never fire a projectile without a fuze or with a fuze that is not authorized for that projectile.

10-7. PROPELLING CHARGES

a. Procedures for preparing and verifying propelling charges are published in respective weapon technical manuals. These procedures are safe, simple, and easy to train.

CAUTION

When firing multiple-round missions, the possibility of firing an incorrect charge is greater than when firing single-round missions because of increased tempo and because sections are rarely allowed to fire multiple-round missions during training. Procedures in the weapon technical manual always must be used.

b. Propelling charges, or powder, like other components of ammunition, must be kept cool and dry. Powder containers must be closed tight to keep moisture out.

c. Propellant bags must be firm, clean, and well laced or tied; and the increments must be inserted in the proper sequence.

d. Propellant must be inspected before the charge is prepared. The following are examples of things to check:

- Missing increments, extra increments and/or incorrect sequencing (order) of increments.
- Increment bags. Bags must not be damaged to the extent that black powder or propellant spills out.
- Rotting (chemical odor).
- The red igniter pad on the base of the base charge (155-mm propelling charges).

e. Do not fire unused powder increments. They should be removed to some storage area (commonly called a powder pit) preferably 30 to 40 feet from the nearest weapon, until they can be burned or otherwise disposed of. The procedures for burning powder are discussed below:

(1) For safety, select a burning site at least 200 feet from grass and loose debris as well as personnel and equipment.

(2) Determine the direction of the wind.

(3) Place charge increments in a single layer row not more than 12 inches wide.

(4) Arrange the row so that the powder will burn into the wind (Figure 10-3).

(5) Lay a train of combustible material about 15 feet long, perpendicular to, and at the downwind end of the row of charge increments. Light this train at the end farthest from the increments (Figure 10-3).

f. Burning powder creates a very large flash and a lot of smoke. In a tactical environment, the platoon leader must ensure that burning powder does not compromise the camouflage and concealment effort,

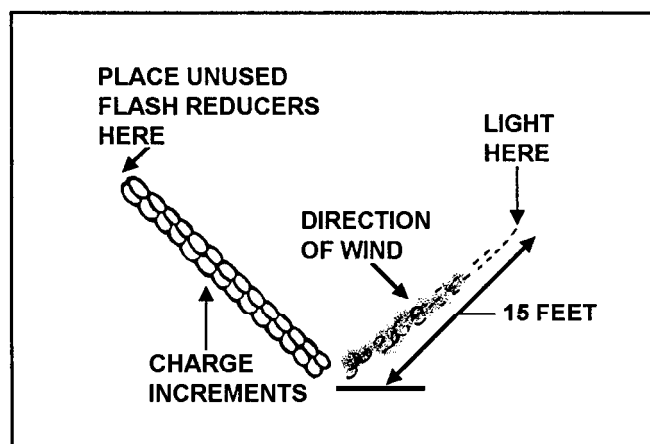

Figure 10-3. Layout for burning powder increments

10-8. FLASH REDUCERS

a. For some propellants, separate flash reducers containing black powder and potassium sulfate must be used to reduce flash at night. The flash reducers speed up the combustion of unburned propellant gases, which helps prevent excessive muzzle blast.

b. Flash reducers **absorb moisture readily**, so they must be kept dry. Keep them off of damp ground and sealed in their containers until needed for use.

c. Destroy flash reducers as shown in Figure 10-3. Flash reducers are highly flammable. It is critical that they be disposed of properly to prevent injury.

d. The M119A2 charge 7 red bag propellant for 155 mm is manufactured with flash reducers attached. **Do not remove these from the propelling charge.**

10-9. PRIMERS

a. Primers are sensitive to both shock and moisture. Primers for separate-loading ammunition should be kept away from the propellant bags and left in their sealed containers until needed.

Note: Older series propellants may contain the MK4A2 primer. This primer is not authorized to be fired with any howitzer currently in use. Ensure that these primers are **not fired and are turned in to the ammunition section.**

b. Primers for semifixed ammunition are attached to the base of the cartridge case. The best way to protect them is to leave them covered with a fiber container cap until needed.

c. Before use, inspect all primers for signs of corrosion. If a seal has been broken, it is very likely that the primer has been affected by moisture and should be turned in.

10-10. CARTRIDGE CASES

a. The cartridge case of semifixed ammunition should be checked for corrosion. Light brown staining is normal oxidation; but black, green, yellow, or white stains mean heavy corrosion, which must be cleaned off as soon as possible (see Figure 10-4, page 10-6).

b. Cartridges must be checked for cracks, bulges, and burs.

c. The primer must be flush with the base of the cartridge. If it sticks out too far, **it is dangerous**. If it sits in too far, the round will not fire. (See Figure 10-5, page 10-6.)

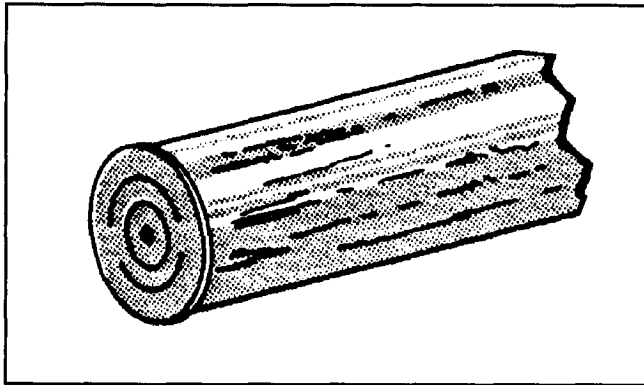

Figure 10-4. Cartridge case

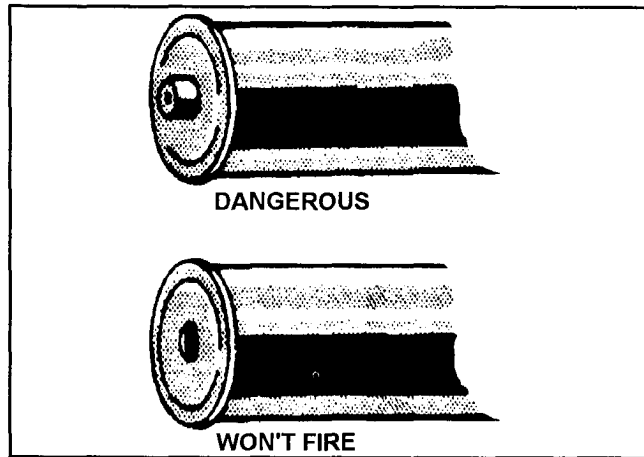

Figure 10-5. Primers

10-11. SEGREGATION OF AMMUNITION LOTS

a. Different lots of propellant burn at different rates and give different effects in the target area. For this reason, the registration corrections derived from one lot do not necessarily apply to another lot. Ammunition must be segregated by lot.

b. The FDC designates the lot of ammunition to be fired for each mission (or it is standardized). Therefore, the lot designator should be prominently displayed for each stack of ammunition.

c. Whether stored in the field, on vehicles, or at an ammunition supply point (ASP), different lots of ammunition must be conspicuously marked.

10-12. FIELD STORAGE OF AMMUNITION

a. The four greatest hazards to ammunition in the battery area are weather, enemy fire, improper handling, and careless

smokers. Regardless of the method of storage, these hazards must be considered. Specific storage techniques are discussed later, but here are some general considerations:

(1) Stack ammunition by type, lot number, and weight zone (Figure 10-6).

(2) If ammunition is being stored on the ground, use good strong dunnage at least 6 inches high under each stack (Figure 10-7).

(3) Keep the ammunition dry and out of direct sunlight by storing it in a vehicle or covering it with a tarpaulin. Be sure adequate ventilation is provided (Figure 10-8).

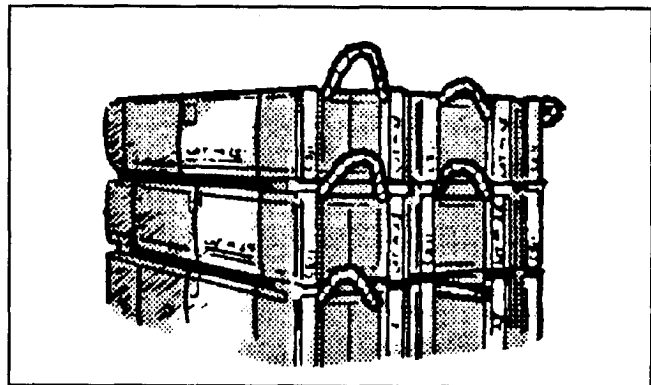

Figure 10-6. Ammunition stack

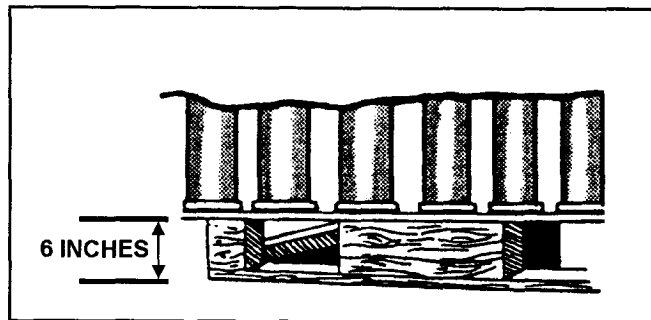

Figure 10-7. Ammunition dunnage

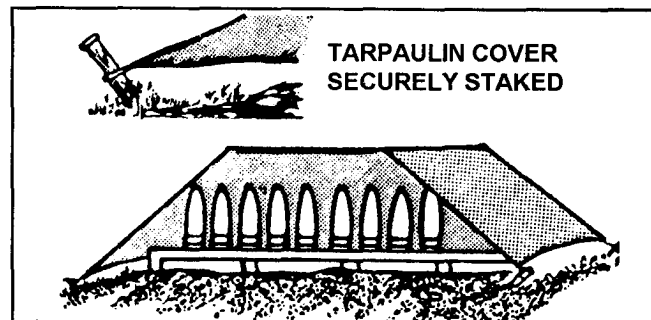

Figure 10-8. Ammunition protection

(4) Provide ammunition, if off-loaded, as much protection from enemy indirect fires as time and available materials allow. If sandbags are used for protection, keep the walls at least 6 inches from the stacks and the roof at least 18 inches from the stacks to ensure proper ventilation.

b. Particular attention must be paid to ammunition temperature. Most ammunition components can be stored at temperatures as low as -80°F for periods of not more than 3 days and as high as +160°F for periods of not more than 4 hours per day. An increase in malfunctions may be experienced with some VT fuzes when the temperature is below 0° or above 120°F. Powder temperature affects the muzzle velocity of a fired round and is a matter of frequent concern to the FDC. At least two howitzer sections should be designated to keep track of the powder temperature. A powder thermometer is inserted into the top powder increment in the canister, and care must be taken to ensure the thermometer does not touch metal.

Note: Cannon sections must be careful not to fire the powder thermometer.

c. Only enough ammunition to meet current needs should be prepared for firing.

10-13. STORAGE AND TRANSPORTATION TECHNIQUES

a. In SP units, the M992 combat ammunition tracked vehicle is the companion vehicle to the howitzer. It serves as an area from which to service the weapon as well as a storage area for ammunition. This vehicle should be positioned with its howitzer and replenished in the battery area by the ammunition section. Ammunition should be left in pallets until needed for use.

Note: Be sure pallets are adequately cribbed and secured to prevent them from shifting during movement.

b. To increase the ammunition-carrying capability of cannon batteries, additional M332 ammunition trailers are authorized in the TOE. Although mobility may be degraded somewhat, an M332 trailer should be pulled by each of the ammunition vehicles currently shown in various TOEs. These are the M992 and the 2½- and 5-ton trucks. These 1½-ton trailers can—

- Increase organic hauling capability,
- Facilitate resupply and backhaul operations, and

- Permit ammunition component segregation (to reduce the battery's vulnerability to counterfire).

c. In towed units, the prime mover, loaded with ammunition, should be positioned near the howitzer. Ammunition should be left loaded until it is prepared for firing. Other ammunition is stored on the battery ammunition section vehicles, or at a battery ammunition dump. The establishment of a battery ammunition dump is a matter of command decision, because it seriously impairs the mobility of the battery.

d. Appendix E provides the load plan for the M925 5-ton truck for M1 98 units.

e. The M992A1 CATV has specific storage locations for ammunition components depicted in its operator manual (TM 9-2350-267-10).

f. The artillery uses the 11 ton heavy expanded-mobility tactical truck (HEMTT), heavy expanded-mobility ammunition trailer (HEMATT), and the palletized load system (PLS) for transporting large quantities of ammunition.

10-14. ACCIDENTS

Generally, firing accidents are serious, so all supervisory personnel should know the immediate action to be taken.

a. If the ammunition or equipment presents further danger, move all personnel out of the area.

b. Do not change any settings on, or modify the position of, the weapon in any way until an investigation has been completed.

c. Record the lot number of the ammunition involved in the accident or malfunction, and report it to the battalion ammunition officer. If there is good reason to suspect a particular lot of ammunition, its use should be suspended.

d. If it is suspected that the propellant was ignited with no recoil of the tube, misfire procedures must follow. Perhaps no projectile was loaded and the propellant is still burning.

10-15. MISFIRE PROCEDURES

Misfires do occur. When they do, there are certain actions that must be taken within specific time limits. For that reason, personnel must be thoroughly familiar with the misfire procedures for their weapon system. These procedures are in AR 75-1 and weapons technical manual for the appropriate weapons.

10-16. TRAINING

a. Traditionally, ammunition training has been a weak area. Cannoneers seldom practice setting time fuzes or cutting propellant charges until the battery goes to the field to conduct live firing. There are several training extension course (TEC)

lessons on ammunition to enhance individual training. Also, your Training and Audiovisual Support Centers (TASCs) have a wide selection of ammunition training materials.

b. Collective training is enhanced by using training rounds, which are available through the local TASC. New training rounds are constantly introduced into the training aids inventory. These rounds are designed to train the entire howitzer crew--from loading ammunition to setting fuzes,

cutting charges, loading, and firing. Keep an up-to-date TASC catalog, and take advantage of these devices.

10-17. AMMUNITION PLANNING GUIDE

Tables 10-2 through 10-4, pages 10-9 through 10-11, give information on ammunition available for various FA weapons. (Figure 10-9 provides a list of acronyms and abbreviations for Tables 10-2 through 10-4.)

| | | | |
|---------------|--|--------------|--|
| ADAM | area denial artillery munitions | ICM | improved conventional munitions |
| APERS | antipersonnel | illum | illumination |
| BB | basebleed | IOC | initial operational capability |
| BD | base detonating (fuze) | L | long (duration) (suffix with ADAM or RAAMS) |
| BE | base ejection (fuze) | MA | muzzle action |
| CP | concrete piercing (fuze) | MAMT | muzzle action, mechanical time (fuze) |
| CS | riot control agent | mod | modified |
| D | delay | MT | mechanical time |
| DODAC | Department of Defense ammunition code | MTSQ | mechanical time super quick (fuze) |
| DOCIC | Department of Defense identification code | ND | nondelay (fuze) |
| DPICM | dual-purpose improved conventional munitions | PD | point detonating (fuze) |
| ET | electronic time (fuze) | prox | proximity |
| FASCAM | family of scatterable mines | RAAMS | remote antiarmor mine system |
| GB | green bag | RAP | rocket-assisted projectile |
| H | blister agent (mustard) | S | short (duration) (suffix with ADAM or RAAMS) |
| HC | hexachloroethane | sec | second |
| HD | blister agent (distilled mustard) | SQ | superquick |
| HE | high-explosive | TBD | to be determined |
| HEAT | high-explosive antitank | VT | variable time (fuze) |
| HEP | high-explosive plastic | VX | nerve agent (persistent) |
| HEP-T | high-explosive plastic-tracer | WP | white phosphorus |
| HERA | high-explosive rocket-assisted | | |

Figure 10-9. Acronyms and abbreviations for Tables 10-2 through 10-4

Table 10-2. Field artillery ammunition planning guide (M101A1, M102, and M119A1)

| PROJECTILES ¹ | DODOC | MAXIMUM RANGES | | | FUZE ACTIONS |
|--------------------------|-----------|----------------|--------|--------|--|
| | | M101A1 | M102 | M119A1 | |
| M546 APERS-T | 1315-C513 | 11,600 | 12,400 | 12,400 | Comes set for MA. Can be set to 100 sec. |
| M360 gas, GB | 1315-C441 | 11,000 | 11,500 | 11,500 | PD |
| M60 gas, H, HD | 1315-C442 | 11,000 | 11,500 | 11,500 | PD |
| M629 gas, tactical CS | 1315-C468 | 11,000 | 11,500 | 11,500 | MT, ET |
| M1 HE (deep cavity) | 1315-C445 | 11,000 | 11,500 | 11,500 | CP, PD, MTSQ, VT, ET |
| M444 ICM, HE | 1315-C462 | 11,000 | 11,500 | 11,500 | MT modified |
| M548 RAP, HE | 1315-C463 | 14,500 | 15,100 | 11,500 | PD, VT, ET |
| M327 HEP-T | 1315-C448 | Direct Fire | | | BD |
| M314A3 illumination | 1315-C449 | 11,000 | 11,500 | 11,500 | MT, ET |
| M84 HC, smoke, BE | 1315-C452 | 11,000 | 11,500 | 11,500 | MT, ET |
| M60 WP, smoke | 1315-C454 | 11,000 | 11,500 | 11,500 | PD |
| M760 HE | 1315-C743 | No | No | 14,000 | PD |
| M913 RAP, HE | 1315-C546 | No | No | 19,200 | PD, VT, ET, MTSQ |

¹ Most 105-mm rounds come complete with primer, propellant, projectile, and fuze. The exceptions are the HE, HERA M548, and some lots of WP M60 that come without fuzes. CP, PD, MTSQ, or VT fuzes, as appropriate, must be drawn as separate items for these rounds. See KEY TO FUZES block below for fuze DODACs.

**KEY TO FUZES
(DODAC = 1390 PLUS DODIC NUMBER AS SHOWN)**

| TYPE | CURRENT | DODIC | REPLACEMENT | DODIC | FUTURE |
|-------------------|--|--------------|------------------------|------------------------|----------------|
| CP delay nondelay | MK399 MOD1 | N659 | None | — | None |
| PD SQ/D SQ/D | M577 M572 | N335 N311 | M739 M739 | N340 N340 | XM773 XM773 |
| MAMT | M563 | NA | None | — | None |
| MT | M565 ¹ M577 ² | N248 | ETM762 | N248 N285 | XM773 XM773 |
| MTSQ | M564 M582 ² | N278 N286 | ETM767 | — | XM773 |
| VT | M513 M514 | N412 N411 | M728/M732 M728/M732 | N463/N464 N463/N464 | XM773 |

¹ M548 MTSQ fuze is being issued and used instead of M565 until stocks are exhausted. See TM 43-0001-28 for additional details.

² M577 and M582 can be set for either MT or SQ. If the fuze is set for MT, SQ action may occur.

Table 10-3. Field artillery ammunition planning guide (M198, M109A5/A6)

| PROJECTILES | DODAC | PROPELLING CHARGES | | | | MAXIMUM RANGE | FUZE ACTION |
|--------------------------|-----------|---|----------------------|-------------------------------|------|---------------|------------------------------|
| | | M3 SERIES | M4 SERIES | M119 SERIES | M203 | | |
| M107 HE | 1320-D544 | Yes, but not zone 1 or 2 | Yes | Yes | No | 18,100 | CP, PD, ET, MTSQ, VT |
| M549A1 RAP | 1320-D579 | No | Yes, but zone 7 only | Yes, but not M119 | Yes | 30,000 | PD, ET, VT (732 only) |
| M449A1 ICM | 1320-D562 | Yes, but not zone 1 or 2 | Yes | Yes | No | 18,100 | MT, ET, MTSQ |
| M485 illum | 1320-D505 | Yes, but not zone 1 or 2 | Yes | Yes, but degraded reliability | No | 17,500 | MT, ET, MTSQ (M577) |
| M483A1 DPICM | 1320-D563 | Yes, but not zone 1 or 2 | Yes | Yes | No | 17,500 | ET, MTSQ (M577) |
| M864 BB DPICM | 1320-D864 | No | Yes (zone 7 only) | Yes | Yes | 28,200 | MTSQ (M577), VT (M762), ET |
| M692 ADAM-L | 1320-D501 | Yes, but not zone 1 or 2 | Yes | Yes | No | 17,740 | ET, MTSQ (M577) |
| M731 ADAM-S | 1320-D502 | Yes, but not zone 1 or 2 | Yes | Yes | No | 17,740 | ET, MTSQ (M577) |
| M116A1 HC | 1320-D506 | Yes, but not zone 1 or 2 | Yes | Yes | No | 18,100 | ET, MTSQ (M577) |
| M110A1 WP | 1320-D550 | Yes, but not zone 1 or 2 | Yes | Yes | No | 18,100 | PD, MTSQ, ET |
| M110 H/HD | 1320-D543 | Yes, but not zone 1 or 2 | Yes | Yes | No | 18,100 | PD, MTSQ, ET |
| M687 binary ¹ | 1320-D594 | Yes, but not zone 1 or 2 | Yes | Yes | Yes | TBD | PD |
| M121 chemical | 1320-D568 | Yes, but not zone 1 or 2 | Yes | Yes | Yes | 18,100 | PD, VT |
| M795 HE ¹ | 1320-D529 | Yes, but not zone 1 or 2 | Yes | Yes | Yes | 22,400 | PD, MTSQ, VT (M732 only), ET |
| M825 smoke | 1320-D528 | Yes, but not zone 1 or 2 | Yes | Yes | Yes | 22,600 | ET, MTSQ (M577) |
| M718 RAAMS-L | 1320-D503 | Yes, but not zone 1 or 2 | Yes | Yes | No | 17,740 | ET, MTSQ (M577) |
| M741 RAAMS-S | 1320-D509 | Yes, but not zone 1 or 2 | Yes | Yes | No | 17,740 | ET, MT |
| M712 Copperhead | 1320-D510 | Yes, but no requirement for zones 1 through 3 | Yes | Yes | No | 16,400 | BD (comes already installed) |
| M804 practice M804A1 | 1320-D513 | Yes, but not zone 1 or 2 | Yes | Yes | No | 18,100 | PD, MTSQ, ET, VT (M572 only) |

¹ Type classified, but not in production.

Table 10-4. Field artillery ammunition planning guide M109A2 (A3/A4)

| PROJECTILES | DODAC | PROPELLING CHARGES | | | MAXIMUM RANGE | FUZE ACTION |
|--------------------------|-----------|---|----------------------|-------------------------------|---------------|----------------------------------|
| | | M3 SERIES | M4 SERIES | M119 SERIES | | |
| M107 HE | 1320-D544 | Yes, but not zone 1 or 2 | Yes | Yes | 18,100 | CP, PD, ET, MTSQ, VT |
| M549A1 RAP | 1320-D579 | No | Yes, but zone 7 only | Yes, but not M119 | 23,500 | PD, ET, VT, MTSQ |
| M449A1 ICM | 1320-D562 | Yes, but not zone 1 | Yes | Yes | 18,100 | MT, ET, MTSQ (M577) |
| M485 illum | 1320-D505 | Yes, but not zone 1 | Yes | Yes, but degraded reliability | 17,500 | MT, ET, MTSQ (M577) |
| M483A1 DPICM | 1320-D563 | Yes, but not zone 1 or 2 | Yes | Yes | 17,500 | ET, MTSQ (M577) |
| M864 BB DPICM | 1320-D864 | No | Yes | Yes | 22,000 | MTSQ (M577), VT (M762), ET |
| M692 ADAM-L | 1320-D501 | Yes, but not zone 1 or 2 | Yes | Yes | 17,740 | ET, MTSQ (M577) |
| M731 ADAM-S | 1320-D502 | Yes, but not zone 1 or 2 | Yes | Yes | 17,740 | ET, MTSQ (M577) |
| M116A1 HC | 1320-D506 | Yes, but not zone 1 | Yes | Yes | 18,100 | ET, MTSQ (M577) |
| M110A1 WP | 1320-D550 | Yes, but not zone 1 | Yes | Yes | 18,100 | PD, MTSQ, ET |
| M110 H/HD | 1320-D543 | Yes, but not zone 1 | Yes | Yes | 18,100 | PD, MTSQ, ET |
| M687 binary ¹ | 1320-D594 | Yes, but not zone 1 or 2 | Yes | Yes | TBD | PD |
| M121 chemical | 1320-D568 | Yes, but not zone 1 | Yes | Yes | 18,100 | PD, VT |
| M795 HE ¹ | 1320-D529 | Yes, but not zone 1 or 2 | Yes | Yes | TBD | CP, PD, ET, MTSQ, VT (M732 only) |
| M825 smoke | 1320-D528 | Yes, but not zone 1 or 2 | Yes | Yes | 17,500 | ET, MTSQ (M577) |
| M718 RAAMS-L | 1320-D503 | Yes, but not zone 1 or 2 | Yes | Yes | 17,740 | ET, MTSQ (M577) |
| M741 RAAMS-S | 1320-D509 | Yes, but not zone 1 or 2 | Yes | Yes | 17,740 | ET, MTSQ (M577) |
| M712 Copperhead | 1320-D510 | Yes, but no requirement for zones 1 through 3 | Yes | Yes | 16,400 | BD (comes already installed) |
| M804 practice | 1320-D513 | Yes, but not zone 1 | Yes | Yes | 18,100 | PD, MTSQ, ET, VT (M572 only) |

¹ Type classified, but not in production.

CHAPTER 11

SAFETY PROCEDURES

11-1. RESPONSIBILITIES

AR 385-63, Chapter 11, implements the chain-of-command safety concept. Under this concept, the firing battery chain of command is responsible for safety during firing, training, and combat. This chapter reinforces AR 385-63. However, if local range regulations are more restrictive than the material in this chapter, the local range regulation must be followed. Specific responsibilities for safety are fixed as discussed below.

a. Commanders of Field Artillery Units Commanders establish and maintain a safety training and certification program for their personnel. The purpose of this program is to train and qualify individual members of the firing battery in the safety procedures for their specific areas of responsibility. When the responsible artillery commander is satisfied that the individual members are qualified to perform the safety duties as required in the firing battery, he certifies them as competent to perform those duties. Sample tests for qualification of safety personnel are in Appendix O.

b. Battalion Commander. The FA battalion commander is responsible for safety during all phases of a firing exercise under his control. The commander selects, trains, and certifies the personnel necessary to assist him in discharging this responsibility. These personnel include, but are not limited to, the firing battery commander, executive officer, fire direction officer, firing platoon leader, chief of firing battery, gunnery sergeant, FDC chief computer, and howitzer chief of section. If any position is not filled by a command safety-certified person, another person who is certified and qualified to fill that position performs the safety checks.

Note: The title of platoon leader and platoon sergeant (in the platoon-based unit) also pertains to executive officer and chief of firing battery/USMC battery gunnery sergeant (in the battery-based unit).

c. Officer in Charge. The officer in charge (OIC) is the battery commander or his command safety-certified direct representative. The OIC is responsible for all aspects of safety in the firing unit and on the assigned firing range. Before the firing exercise, the range control officer provides the OIC the required safety data and any firing limitations. The OIC verifies that the unit is in the proper firing position. He supervises the conversion of the safety data into a safety diagram and ensures that this diagram is verified by another

command safety-certified person. The safety diagram provides right and left direction limits, minimum and maximum quadrant elevations for authorized charges, and minimum safe fuze times. The safety diagram, modified as necessary by minimum QE, is given to the appropriate members of the firing battery. The OIC is responsible for ascertaining locations of friendly personnel who may inadvertently be exposed to artillery fires. He ensures dissemination of this information to subordinate XO's, platoon leaders, FDO's, chiefs of firing battery, platoon sergeants, gunnery sergeants, and chiefs of section, as appropriate, so they are aware of potential situations which might result in fratricide.

d. Firing Platoon Leader. The firing platoon leader is responsible for the safety practices of the firing element. He will ensure that the chiefs of section have safety data. He determines the lowest QE that can be safely fired from his firing position and ensures that projectiles clear all visible crests (min QE) (see Chapter 6). He is assisted by the FDO, platoon sergeant, and the gunnery sergeant.

e. Fire Direction Officer. The FDO has primary responsibility for computing safety data and ensuring all safety diagrams are updated after registrations and receipt of current met data. He is responsible for plotting the impact area on a map or chart in the FDC. He is assisted in his duties by the chief computer. He ensures all firing data are within prescribed safety limits before they are sent to the firing sections. He adjusts minimum QE for intervening crests.

f. Platoon Sergeant. The platoon sergeant helps the platoon leader in his duties. He performs many of the platoon leader's duties in his absence. His main responsibilities are laying the platoon, performing the duties as platoon leader, and working in shifts with the platoon leader.

g. Howitzer Section Chief. The section chief supervises all practices that take place at or near his weapon. These include verifying that the announced safe data are applied to his weapon and that the proper charge, fuze, and projectiles are fired. He has the final responsibility for the firing of his weapon.

h. Range Control Officer. The range control officer gives the OIC of the firing unit the following safety data:

- The grid coordinates of the firing position.
- The lateral safety limits.

- The minimum and maximum ranges.
- The authorized ammunition to be fired (fuze, projectile and charge).
- The maximum ordinate (high angle or low angle).
- The hours during which the firing may be conducted.

11-2. DUTIES OF SAFETY PERSONNEL

A separate battery safety officer is not required during the firing of field artillery. Normally, the platoon leader will perform these functions. The platoon leader **is not** required to verify all data placed on the on-carriage fire control equipment. He may use safety stakes, safety tape, or physical constraints on the weapon to ensure that the safety limits are not exceeded. All key personnel must be thoroughly familiar with six references: AR 385-63, FM 6-40, FM 6-50, TM 43-0001-28, the appropriate TM for the weapon, and local range regulations. In case of conflict, local range regulations always take precedence.

Note: These references are guidelines that may be used in developing units' SOPs.

a. Specific duties of safety personnel before firing are, but **are not limited to**, the following:

(1) Verify that the data the range control officer gives the OIC apply to the unit firing, that the unit is in the correct location, and that the data are correct. (OIC and safety officer)

(2) Compute and verify the safety diagram. (At least 2 safety-certified personnel, normally the platoon leader and FDO)

(3) Ensure that all personnel and equipment are clear from surface danger area E before firing (see AR 385-63 for the dimensions of surface danger area E for specific weapon systems).

(4) Check the DA Form 581 (Request for Issue and Turn-In of Ammunition) and range safety card to ensure that only authorized ammunition is fired. (Platoon leader or platoon sergeant)

(5) Ensure no safety violations occur at or near the weapon(s). (All members of the firing unit)

(6) Check the weapons for correct boresighting. (Section chief)

(7) Verify the lay of the battery. (Platoon leader or platoon sergeant)

(8) Compute and verify MIN QE. (Platoon leader or FDO)

(9) Compare minimum QE with the QE for minimum range shown on the safety diagram. Use the larger of the two as the minimum QE. (Platoon leader or FDO)

(10) Verify that the section chief has safety data (safety T). Ensure section chiefs are advised of all friendly personnel in the area that may inadvertently be exposed to FA direct or indirect fires. (Platoon leader or platoon sergeant)

(11) Supervise and check the emplacement of safety aids (stakes, tape, and other devices). (Platoon leader, platoon sergeant, or gunnery sergeant)

(12) Verify that range clearance has been obtained. (Platoon leader or FDO)

b. Specific duties of safety personnel during firing are, **but are not limited to**, the following:

(1) Verify the serviceability of ammunition. (Section chief)

(2) Supervise key safety personnel in the performance of their duties. (OIC or safety officer)

(3) Verify that the charges, projectiles, and fuzes being fired are only those prescribed on the safety card. (Section chief, platoon leader, or platoon sergeant)

(4) Visually inspect to ensure that the correct shell-fuze combination, time if required, and charge are properly prepared and loaded on each round. Verify that the correct number of remaining powder increments are removed to the powder pit before loading and firing each round. (Section chief)

(5) Verify that rounds are not fired below the minimum QE or above the maximum QE. (Section chief, platoon leader, or platoon sergeant)

(6) Verify that rounds are not fired outside the lateral (deflection) safety limits specified on the safety card. (Section chief, platoon leader, or platoon sergeant)

(7) Verify that time-fuzed rounds are not fired with fuze settings that are less than the minimum time prescribed on the safety diagram. (Section chief, platoon leader, or platoon sergeant)

(8) On all commands that are unsafe to fire, command **CHECK FIRING** and give the reason(s) why the command is unsafe. (Section chief)

EXAMPLES

UNSAFE TO FIRE, 3 MILS OUTSIDE RIGHT SAFETY LIMIT AND 20 MILS ABOVE MAXIMUM QUADRANT ELEVATION.

and

UNSAFE TO FIRE, 5 MILS BELOW MINIMUM QUADRANT ELEVATION.

(9) Recompute and issue updated safety Ts under the following conditions: (FDC)

- When a registration is completed.
- When met conditions change.
- When restrictions change.

(10) Suspend firing when any unsafe condition exists. (Any person who sees an unsafe act) Examples of unsafe conditions are as follows:

- Powder bags exposed to fire.
- Personnel smoking near pieces of ammunition.
- Improper handling of ammunition.
- Time fuze previously set and not reset to safe.
- Personnel or aircraft directly in front of the weapon.
- Primer inserted into the firing assembly before breech is closed (separate-loading ammunition).
- Failure to inspect powder chamber and bore after each round is fired.
- Failure to swab powder chamber after each round of separate-loading ammunition is fired.

c. Specific duties of safety personnel after firing are, but **are not limited to**, the following:

(1) Verify that unused powder increments are disposed of at an approved place in the correct manner.

(2) Verify that all unfired ammunition is properly accounted for, repacked, and returned to the ammunition resupply point.

(3) Verify police of the firing position.

(4) Verify that all safety Ts are collected and properly disposed of.

11-3. SAFETY AIDS

a. From the range safety card, the fire direction officer prepares a safety diagram and safety Ts for use by the safety-certified personnel. Safety aids are used to ensure that only safe data are fired from the position. Two such safety aids are the safety stakes and safety tape. These aids are then used as a visual check to ensure that the howitzer is laid within safety limits.

b. Emplace safety aids for the M101A1 howitzer as follows:

(1) Deflection safety aids.

(a) Set off the left deflection limit on the pantel using the non-slipping scale. Traverse the tube to establish the proper sight picture on the aiming point.

(b) Place the safety stake against the left side of the tube, and drive it firmly into the ground.

(c) Mark the right deflection limit in the same manner, but emplace the safety stake on the right side of the tube.

(2) Quadrant Elevation Safety Aids.

(a) Set off the maximum QE on the range quadrant.

(b) Mark the elevation scale with a piece of tape in line with the index mark.

(c) Mark the minimum QE in the same manner.

c. Emplace safety aids for the M 102 or M119A1 howitzer as follows:

(1) Deflection safety aids.

(a) Set off the left deflection limit on the pantel by using the deflection counter. Traverse the tube to establish the proper sight picture on the aiming point.

(b) Emplace the safety stake against the right side of the lunette and drive it firmly into the ground.

(c) Mark the right deflection limit in the same manner, but emplace the safety stake on the left side of the lunette.

(2) Deflection safety aids (M119A1).

(a) Lay in the center of traverse (A, Figure 11-1, page 11-4).

(b) Determine the left limit and traverse the tube to the maximum left. Traverse the carriage right until the tube is at the left limit. Emplace the left limit safety stake as shown in B, Figure 11-1.

(c) Determine the right limit, and traverse the tube to the maximum right. Traverse the carriage left until the tube is at the right limit. Emplace the right limit safety stake as shown in C, Figure 11-1.

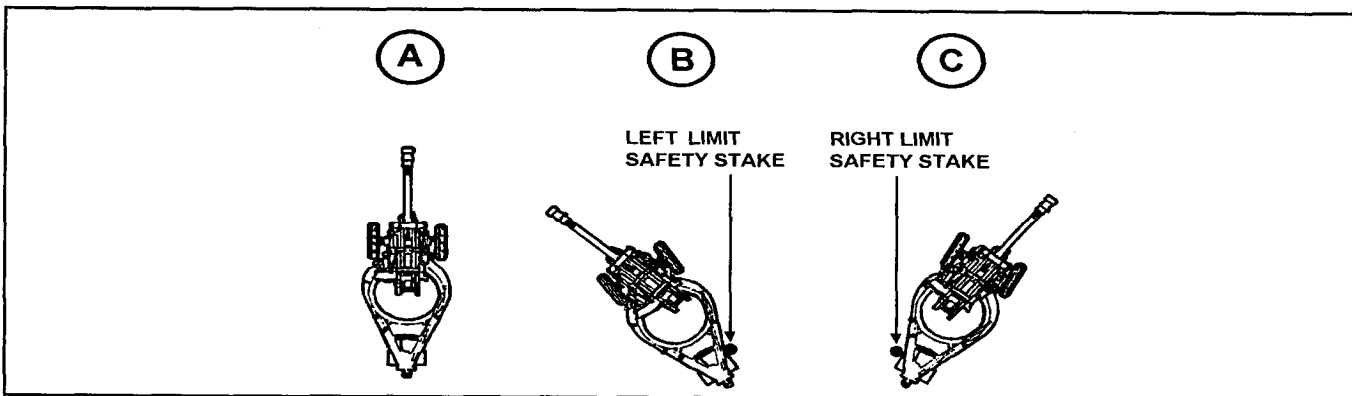

Figure 11-1. Establishment of M119A1 safety limits

(3) Quadrant elevation safety aids.

(a) Use the cam follower as an index mark.

(b) Set off the maximum QE on the fire control quadrant. Elevate the tube until the bubbles center in the elevation level vials.

(c) Mark the cam with a piece of tape in line with the cam follower.

(d) Mark the minimum QE in the same manner.

d. Emplace safety tape on the M198 howitzer as follows:

(1) Deflection safety aids.

(a) With the tube parallel to the azimuth of lay, (deflection 3200) place a piece of tape over the azimuth counter (bottom carriage).

(b) Set off the left deflection limit on the panel by using the deflection counter. Traverse the tube to establish the proper sight picture on the aiming point.

(c) Using a straightedge, draw a line on the tape placed on the bottom carriage directly below the azimuth counter index mark found on the upper carriage. Record the left deflection limit next to that line.

(d) Mark the right deflection limit in the same manner.

(2) Quadrant elevation safety aids.

(a) With the tube elevated at 0 mils, place a piece of tape on the trunnion support, and draw a straight line as an index.

(b) Set off the minimum QE on the fire control quadrant. Elevate the tube until the bubble centers in the elevation level vial.

(c) Place a piece of tape on the quadrant mount. Draw a line across from the index line established on the trunnion support. Record the minimum QE next to that line.

(d) Mark the maximum QE in the same manner.

e. Emplace safety aids on the M109A2-A5 howitzer as follows:

(1) Deflection safety aids. These may be marked on the exterior and/or interior of the hull.

(a) Make an index mark on the top carriage with a piece of tape.

(b) Set off the left deflection limit on the panel using the reset counter. Traverse to pickup a proper sight picture on the aiming point.

(c) Place a piece of tape on the bottom of the carriage directly under the index mark.

(d) Mark the right deflection limit in the same manner.

(2) Quadrant elevation safety aids. These may be marked on the exterior or the interior of the weapon. Emplace the safety aids on the interior of the weapon, as shown in paragraph d(2) above. Mark the exterior of the weapon as follows:

(a) Mark an index on the tube with a piece of tape.

(b) Set off the maximum QE on the fire control quadrant. Elevate the tube until the bubble centers in the elevation level vial.

(c) Place a mark on the top carriage in line with the index mark.

(d) Mark the minimum QE in the same manner.

11-4. SAFETY COMPUTATIONS

a. Information on manual safety computations is in FM 6-40, Appendix B.

b. Safety can be computed by computer, using the automated range safety system (ARSS).

CHAPTER 12

COMBAT SERVICE SUPPORT

12-1. RESPONSIBILITIES

Combat service support (CSS) consists of the logistics and personnel service support required to sustain the cannon battery. Detailed coordination and planning are required to obtain supplies and services. The battery must **relinquish** CSS assets to the battalion trains to facilitate resupply operations for the battery. Key personnel provide direction and are responsible as follows:

- a. The battery commander has overall responsibility for CSS operations. When authorized, he is assisted in this area by the battery executive officer.
- b. The first sergeant of the firing unit coordinates and directs the activities of the supply sergeant, who is the primary executor of the logistics function. The first sergeant ensures the timely evacuation and reporting of casualties; he also requisitions replacements. He is responsible for assigning enlisted personnel within the battery.

12-2. BATTALION TRAIN

- a. The execution of CSS functions is removed from the BC, as much as possible, and is centralized under the control of the battalion. The CSS responsibility at battery or platoon level is to report and request requirements and to ensure that CSS is properly executed once it arrives in the unit area.
- b. The battalion commander task-organizes the CSS assets and normally echelons his trains. The combat trains are located 5 to 8 kilometers behind the battery or platoon firing positions. The administration and logistics operation center (ALOC) is the combat trains CP and is the focal point for CSS for the battalion. The ALOC anticipates, requests, coordinates, and supervises CSS execution.
- c. The battalion field trains collocate with the forward support battalion (FSB) in the brigade support area (BSA). The field trains CP is referred to as the battalion support operations center (BSOC). The BSOC coordinates directly with the ALOC to ensure that the CSS requirements of the batteries are met in a timely manner.

Note: CSS in battery-based units is accomplished through the unit trains, which are collocated with the forward area support team (FAST) in the BSA. The light FA battalion logistics CP at the unit trains is the ALOC. There are no combat trains.

12-3. LOGISTICS PACKAGES

Normally, support is provided by the automatic push of supplies and equipment to the battery at specified times. The logistics package (LOGPAC) includes most classes of supply (less Class V), mail, and replacement personnel and weapons systems as appropriate. The primary means of receiving a LOGPAC is through a logistics release point (LRP). An LRP is an identifiable location where the battery supply representative or guide can link up with the support package and move it forward to the battery or platoon location. The LRP site is selected by the ALOC and is announced to all elements. Usually, the LRP is located astride the main supply route (MSR), near the combat trains.

12-4. BATTERY INTERFACE WITH THE ALOC

- a. The CSS necessary to the battery is normally located within the battery area and consists of maintenance, supply, and ammunition sections. All or part of these elements may be organic to the battalion or consolidated under battalion control. Support may be provided by contact teams attached to the battery, or support may be pushed forward to the battery on an as-required basis. The maintenance section may be attached to the firing batteries during tactical operations. In this situation, the battery is configured with either two heavy platoons (maintenance assets split between them), a heavy platoon and a light platoon (maintenance contact team collocated with the heavy platoon), or with two light platoons and a battery trains. The supply section (supply sergeant) can remain with the battery and act as the primary logistics executor for the battery or the supply section can operate from the field trains (unit trains) to coordinate resupply requirements and execute LOGPACs. The food service and ammunition sections are normally consolidated in the field trains. They provide the needed support for the battery, pushing food and ammunition forward to the unit as necessary.

Note: Maintenance, supply, and ammunition assets may be organic to the FA battery or may be consolidated at battalion by design or task organization. At battery level, supply is a function rather than a section.

b. Supplies, logistics services, replacement weapons systems, mail, pay, personnel actions, and all other services will come from the field trains through coordination with the BSOC. The battery first sergeant, through the battery motor sergeant and supply sergeant, coordinates with the appropriate staff officer in the ALOC to obtain required supplies or services. Some supplies and services come to the battery as part of the LOGPAC. These are mail; pay; bulk petroleum, oil and lubricants (POL); and rations. Ammunition is not a part of the LOGPAC. Ammunition resupply is a continuous process to ensure the battery mission can be fulfilled.

c. The unit basic load (UBL) is a specified amount of Class I, II, III, IV, V, VIII and preprinted forms with which the unit will deploy on organic transportation. In some cases, the UBL is a set number or amount. In other cases, it is based upon the number of miles to be traveled or personnel authorized within the battery. Local commands provide the data necessary to compute the basic load for the battery.

12-5. CLASSES OF SUPPLY

a. Class I (Rations). Normally, the UBL specifies that combat rations (meals, ready to eat [MREs]) for 3 to 5 days will be maintained by the battery. Replenishment of the consumed UBL is coordinated through the battalion S-4 and delivered when the tactical situation permits. A- or B- rations are prepared in the field trains and delivered to the LRP and on to the platoon position areas for consumption as part of the LOGPAC. Under the field feeding system, T- rations can either be prepared at the field trains or pushed forward to the platoons and prepared on site.

b. Class II and IV (Expendable Supplies, NBC Suits, Sandbags, Concertina Wire, and So Forth). The consumption varies greatly between Class II items and Class IV items. It depends upon the intensity of the battle and the requirements of the battery to displace quickly. If the battery is operating in an NBC environment, the use of NBC protective equipment must be closely monitored to allow the supply system to replace items as required. Special coordination must take place when the battery goes through a decontamination site. Normally, the chemical company operating the site does not have the required replacement overgarments. Requests for Class II and IV items are

submitted in any form to the ALOC. These items are received as part of the LOGPAC.

c. Class III (POL). Petroleum, oils and lubricants are received as part of the LOGPAC. Battery vehicles must not be allowed to run low on fuel and must be topped off when fuel reaches the 50 percent level. Along with the top-off of battery vehicles, all fuel containers must be filled.

d. Class V (Ammunition). Normally, ammunition is constantly pushed to the battery by the consolidated assets of the battalion ammunition section and the organic ammunition resupply vehicles in each battery. A LOGPAC could occur simultaneously with a normal Class V push to the tiring batteries, and they could use them to resupply/cross-level small arms. The three methods of Class V resupply are discussed below.

(1) Push to a flat rack transfer point (FRTP) (double loop method). The battalion ammunition section vehicles pick up the ammunition from the ammunition transfer point (ATP) in the BSA. They take it to a battalion level flat rack transfer point. The ALOC/combat trains is a good initial choice for the location of the FRTP. At the FRTP, the ammunition section chiefs, with guidance from the BAO and the battalion ammo sergeant, configure flat racks as outlined by the S3. They then drop the flat racks and wait for the empty flat racks from the battery it is habitually associated with. The firing battery returns an empty flat rack or a flat rack with residue. He drops the flat rack and picks up his designated flat rack in a combat-configured load (CCL) configuration. This one-for-one exchange of flat racks must occur to maintain the flow of ammunition resupply. In addition, this helps the ammunition section chiefs maintain control of their assets, and this assists the BAO and battalion ammo sergeant with resupply operations. The firing battery driver returns to the battery location with the loaded flat rack. The ammunition section chief returns to the ATP with the empty vehicle to receive more ammunition and discard the residue in peacetime. This method minimizes problems of battery movement and saves time because both drivers know the procedures and routes. If coordination has been done between batteries, the BAO, S4, ATP, and so on, this is the fastest method of ammunition resupply. See Figure 12-1.

(2) Push to battery (single loop method). In this method, the ammunition is drawn from the ATP and the same operator delivers the ammunition to the battery position. Success depends on the ability of drivers to find both the battery and the ATP. Use of this method depends upon the driver's familiarity with the area and the urgency of need for the ammunition by the battery. See Figure 12-2.

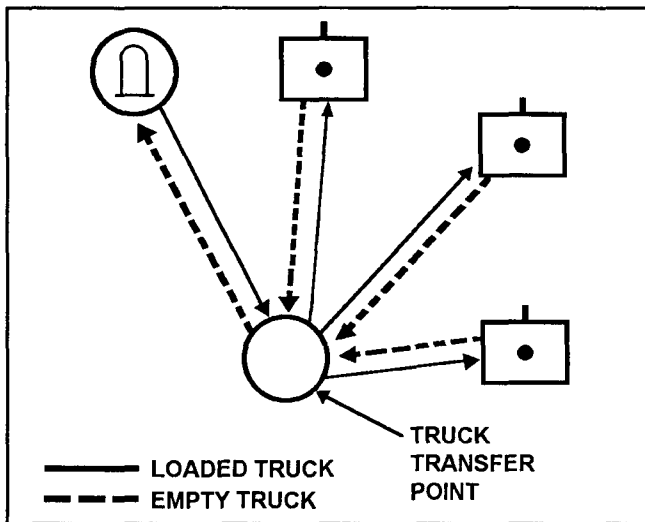

Figure 12-1. Double loop method of resupply

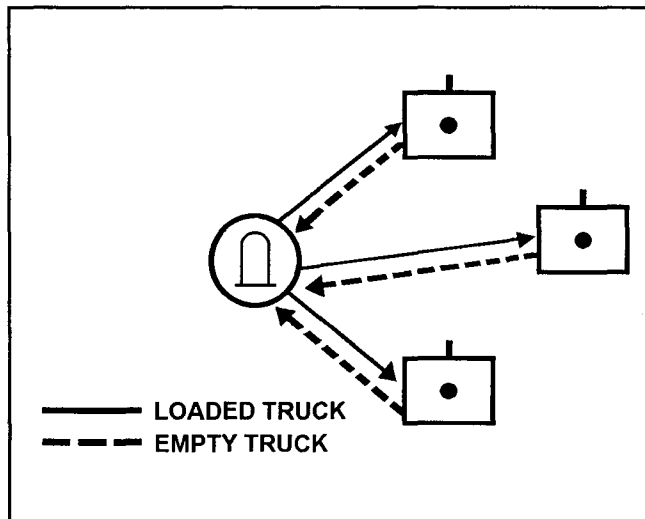

Figure 12-2. Single loop method of resupply

(3) Rearm, refuel, resupply point (R3P). This technique usually emphasizes Class III and V resupply requirements, typically along the route of an extended battalion road march. The battalion XO designates a key combat service support leader to execute the R3P. The site will provide Class III and V resupply facilities in a service station layout along the route of march to the subsequent firing position.

e. Class VII (Major End Items). These items will be issued as individual item of equipment or using weapon system replacement operations (WSRO) items. A WSRO item is to be issued complete with fire control and communications equipment. The crew should have had the opportunity to test the fire system and ensure it is operational. Once the crew has in-processed at the BSOC, the

WSRO-prescribed item will come forward to the battery as part of the next LOGPAC.

f. Class VIII (Medical Supplies). Medical personnel request supplies from the next higher medical activity. When received, these supplies will come forward as part of the battery LOGPAC. The battery medic(s) consolidate their resupply requirements and those of the combat life savers and forward these to the battalion aid station.

g. Class IX (Repair Parts). The prescribed load list (PLL) identifies the quantity of combat-essential repair parts authorized to be on hand or on order at all times. The unit PLL clerk will request repair parts from the ALOC. When the part is procured, it comes forward as part of the LOGPAC. Parts necessary to repair nonmission-capable equipment should be sent forward under the control of the battalion motor officer (BMO), battalion maintenance technician (BMT), or senior mechanic.

12-6. MAINTENANCE, RECOVERY, AND REPAIR

a. Success on the battlefield is directly related to the ability of the unit to keep equipment and material in effective operating condition. When breakdowns do occur, equipment must be repaired as far forward as possible and by the lowest echelon possible. Battle damage assessment and repair (BDAR) is an expeditious method of getting battle damaged equipment (major end items) operationally capable. It may involve bypassing standard repair procedures, cannibalizing, or repairing components using field expedient methods to get the equipment up as quickly as possible. BDAR procedures shall be used only in combat, at the direction of the commander. Equipment repaired by BDAR means shall be repaired by standard maintenance procedures as soon as practical after the mission is completed. Operators should be familiar with BDAR technical manuals for their specific equipment. They provide repair procedures and guidelines for battlefield repairs. When equipment must be moved, it is moved only as far as necessary for repair. The battery must recover extensively damaged equipment to the nearest maintenance collection point or request assistance from battalion. Further evacuation beyond the maintenance collection point is the responsibility of the DS maintenance unit operating the point.

b. Each FA cannon battalion is authorized an FA maintenance support team from the nondivisional intermediate (DS) maintenance company. Equipment with faults not authorized for unit repair is repaired or replaced by the FA maintenance support team. This team is organized with limited capability, but it can help the battalion keep equipment available. Consideration should be given to placing this team in the combat trains for ease of coordination.

The FA maintenance support team gets DS-level repair parts from its parent unit.

c. Battery maintenance responsibilities are as follows:

(1) Commanders are responsible to ensure that each item of equipment has an assigned operator. The operator is responsible for operator-level maintenance using the appropriate -10 technical manual.

(2) The first-line supervisor supervises the individual operator and crew in maintenance activities.

(3) The maintenance section performs battery-level maintenance with the assistance of the crew. This includes minor repairs and limited battlefield recovery. The maintenance section also assists in evacuation.

(4) The motor sergeant supervises the maintenance section. He ensures the necessary repair parts are requested and that required test equipment and tools are available.

(5) Normally, the motor officer is the platoon leader (platoon-based unit) or XO (battery-based unit). He supervises maintenance within the unit and establishes priorities for repair.

d. The complete unit maintenance team consists of the operator and/or crew, and battery maintenance personnel.

(1) The operator and/or crew must perform PMCS as directed by the -10 technical manual. PMCS includes inspecting, servicing, tightening, and lubricating the piece of equipment as well as caring and accounting for the basic issue items (BIIs). Equipment faults that cannot or should not be repaired by the operator or crew are recorded on DA Form 2404 (Equipment Inspection and Maintenance Worksheet) or DA Form 5988E. This form is submitted through the first-line supervisor to the battery motor sergeant.

(2) The battery maintenance section, with operator and/or crew assistance, performs services listed in the -20 technical manual. These include scheduled periodic services, authorized repairs, road testing, assistance in battlefield recovery, and limited assembly replacement.

e. Recovery capabilities of the battery are limited. Therefore, vehicles should be repaired on site if possible. If evacuation or repair by a higher level maintenance

organization is required, a request should be submitted to the battalion motor officer or maintenance technician. FM 20-22 gives detailed information and guidance for all recovery operations.

12-7. REFUEL, REARM, AND RESUPPLY POINT

When the tactical situation permits, a battalion R3P site (Figure 12-3) may be established to provide critical CSS to the battery. This technique involves the movement of critical battalion CSS elements (trains) to a location where the firing elements can pass through and take on needed ammunition and POL. Then the combat trains elements march-order and proceed from the site to a new location. Daylight operations, unless conducted expeditiously, are vulnerable and dangerous. Personnel may not be available in a fluid, fast-moving situation to provide the necessary security. Night operation of the R3P is the optimum tactical solution.

a. **Selection.** The site should-

- Be on or near the route of march for the firing elements.
- Provide good trafficability.
- Allow cover and concealment.

b. **Organization.** In organizing the site, the following should be considered.

- Dispersion.
- Camouflage.
- Operations security (OPSEC).

c. **Activities.** Some of the activities that can take place at the R3P are as follows:

- Key personnel (firing battery) briefing.
- Tailoring to meet the needs of the unit.
- POL, ammunition, maintenance, and rations (priorities) resupply.
- Local security (augmented by firing battery).
- Ammunition transfer point activities.

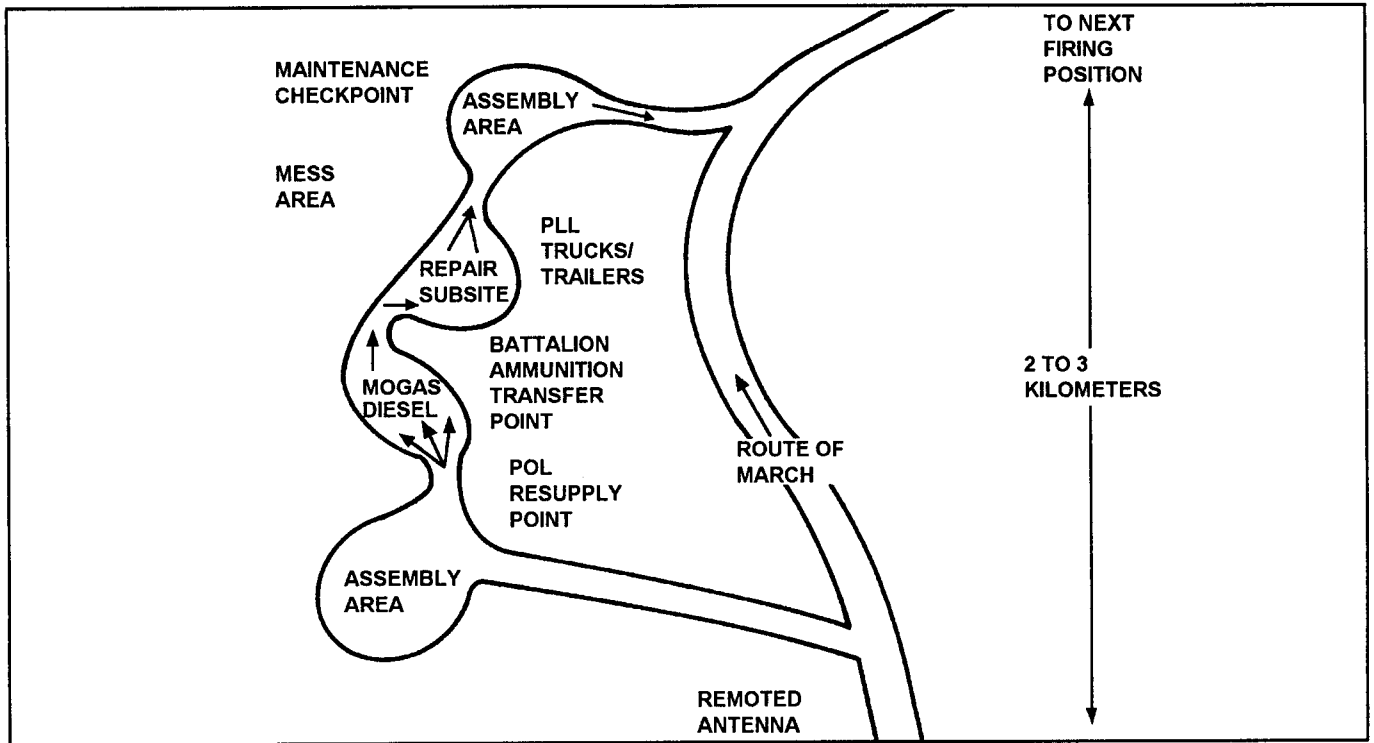

Figure 12-3. R3P site

APPENDIX A
STANDARDIZED PROCEDURES

The procedures listed in Table A-1 have been standardized under the Department of the Army standardization program.

Table A-1. Standardized procedures

| MAJOR CATAGORY | MEASURE | REFERENCE |
|----------------------------------|--|-------------------------------|
| Emergency actions | Defense against air attack | Page 3-17, paragraph 3-17 |
| Fire direction safety procedures | Safety duties | Chapter 11 |
| Physical configuration | 5-ton prime mover load plan for M198 section | Page E-1, Figure E-1 |
| Physical configuration | Camouflage configuration for M102/M119A1 | Page E-2, Figure E-2 |
| Physical configuration | Camouflage configuration for M109A2-A5 | Page E-2, Figures E-3 and E-4 |
| Physical configuration | Camouflage configuration for M198 | Page E-2, Figure E-5 |
| Physical configuration | Camouflage configuration for M101A1 | Page E-3, Figure E-6 |

APPENDIX B
SAMPLE GUNNER'S QUALIFICATION TEST

B-1. USE OF TEST

a. This appendix presents the test that evaluates the 13B (0811) soldier (Marine) in the performance of the principal duties of the gunner. This test applies to all weapon systems and has the following purposes:

(1) The tasks in this test should be used as a training tool. The soldier should practice each task under close supervision to acquire the degree of proficiency required by the standards stated in this test.

(2) This test can bolster the esprit and motivation of the soldier through recognition of individual proficiency. The Artillery clasp for the marksmanship badge will be awarded upon completion of this test (see AR 672-5-1).

b. This test will be given at least semiannually.

B-2. STANDARDS OF PRECISION

The soldier will be required to perform the tasks in accordance with the following standards:

a. Settings must be exact.

b. Bubbles in leveling vials must be centered exactly.

c. The cross hair of the reticle pattern on the panoramic telescope must be aligned exactly on the left edge of the aiming post, on the 0 line of the collimator (or offset correctly to counter the effects of displacement), center mass of the compass or reflector of the aiming circle, or on the top left edge of the distant aiming point.

d. The final motion of the elevating handwheel must always be in the direction that raises the cannon tube.

e. Azimuth knobs must be rotated so as to approach the aiming point from left to right.

f. The appropriate deflection correction must be set on the gunner's aid.

g. Correct terms must be used.

h. Correct hand and arm signals must be used.

i. If any questions arise, refer to the appropriate technical manual and then to FM 6-50.

B-3. ASSISTANCE

The soldier will not receive assistance on the individual tasks but will be provided an assistant on those tasks which require one. If the soldier fails any task because of the fault of the assistant, that task will be retested.

B-4. TASK SCORING

Scoring will be in accordance with the standards for each task. A NO-GO will be given if any of the standards of precision (B-2) or the standards of a specific task are not met, and 0 points will be awarded. If the soldier receives all GO ratings for the standards, the score for the task will depend on the speed of execution.

B-5. QUALIFICATION SCORES

Scores determining the qualification status of the gunner are shown on Table B-1.

Table B-1. Gunner qualification scores

| WEAPON | | | | | | |
|---------------------|--------|-------|--------|-------|-----------|--------|
| Classification | M101A1 | M102 | M119A1 | M198 | M109A2-A5 | M109A6 |
| SCORE | | | | | | |
| Expert Gunner | 92-84 | 92-84 | 72-64 | 84-75 | 92-84 | 92-84 |
| Gunner First Class | 83-76 | 83-76 | 63-57 | 74-67 | 83-76 | 83-76 |
| Gunner Second Class | 75-66 | 75-66 | 56-50 | 66-58 | 75-66 | 75-66 |
| Unqualified | 65-0 | 65-0 | 49-0 | 57-0 | 65-0 | 65-0 |

**B-6. EQUIPMENT, PERSONNEL,
AND SITE REQUIREMENTS**

a. Successful administration of the test is enhanced by efficient organization of the test site. The test site will consist of the following:

- (1) An in-briefing station.
- (2) A chief examiner.
- (3) An examiner for each station and an assistant if required.
- (4) Six howitzers in the firing position with BII.
- (5) An aiming circle with communications.

(6) Two direct fire targets, 600 meters in front of the test site and 50 meters apart.

(7) At least one distant aiming point.

b. Soldiers will use the round-robin method to move from station to station. The examiner will be the same for each station. Each examiner will have a clip board and stop watch.

c. The chief examiner will brief each soldier on the test site and what tasks are on each howitzer. He will explain the scoring system and answer any questions.

d. A test outline is shown in Table B-2. A sample grading sheet is shown in Table B-3.

Table B-2. Test outline

| TASK NUMBER | SUBJECT | ELEMENTS | POINTS PER ELEMENT | MAXIMUM CREDIT |
|------------------------------|--|----------|--------------------|----------------|
| 1 | Laying the Cannon for Initial Direction of Fire Using the Aiming Circle | 1 | 4 | 4 |
| 2 | Laying the Cannon for Initial Direction of Fire Using the M2 Compass | 1 | 4 | 4 |
| 3 | Laying the Cannon for Initial Direction of Fire Using a Distant Aiming Point | 1 | 4 | 4 |
| 4 | Laying Another Cannon Reciprocally | 1 | 4 | 4 |
| 5 | Refer the Piece | 1 | 4 | 4 |
| 6 | Aligning the Collimator | 1 | 4 | 4 |
| 7 | Aligning the Aiming Post | 1 | 4 | 4 |
| 8 | Boresighting the Howitzer | 5 | 4 | 20 |
| 9 | Verifying Boresight with the M140/M139 | 1 | 4 | 4 |
| 10 | Conducting Fire Missions | 5 | 4 | 20 |
| 11 | Direct Fire | 4 | 4 | 16 |
| 12 | Laying a Howitzer for Quadrant with the Range Quadrant | 1 | 4 | 4 |
| 13 | Measuring the Quadrant with the Range Quadrant | 1 | 4 | 4 |
| 14 | Initializing the AFCS | 1 | 4 | 4 |
| 15 | Prepare to Fire Using the AFCS | 1 | 4 | 4 |
| 16 | Conduct Fire Missions Using the AFCS | 1 | 4 | 4 |
| 17 | Perform Direct Fire Using AFCS | 1 | 4 | 4 |
| Total Points Possible | | | | 112 |

Table B-3. Recommended grading sheet

| GUNNER'S NAME | | SECTION | UNIT |
|---------------|---|---------|---|
| SECTION CHIEF | | DATE | WEAPON SYSTEM |
| TASK | | | POINTS ACHIEVED |
| TASK 1 | Laying Using Aiming Circle | | NO-GO = 0 POINTS TIME ____ = ____ POINTS |
| TASK 2 | Laying Using M2 Compass | | NO-GO = 0 POINTS TIME ____ = ____ POINTS |
| TASK 3 | Laying Using DAP | | NO-GO = 0 POINTS TIME ____ = ____ POINTS |
| TASK 4 | Laying Reciprocally | | NO-GO = 0 POINTS TIME ____ = ____ POINTS |
| TASK 5 | Refer the Piece | | NO-GO = 0 POINTS TIME ____ = ____ POINTS |
| TASK 6 | Aligning the Collimator | | NO-GO = 0 POINTS TIME ____ = ____ POINTS |
| TASK 7 | Aligning the Aiming Post | | NO-GO = 0 POINTS TIME ____ = ____ POINTS |
| TASK 8A | Boresight Pantel with Testing Target | | NO-GO = 0 POINTS TIME ____ = ____ POINTS |
| TASK 8B | Boresight Elbow Telescope With Testing Target | | NO-GO = 0 POINTS TIME ____ = ____ POINTS |
| TASK 8C | Boresight Pantel Using a DAP | | NO-GO = 0 POINTS TIME ____ = ____ POINTS |
| TASK 8D | Boresight Elbow Telescope Using a DAP | | NO-GO = 0 POINTS TIME ____ = ____ POINTS |
| TASK 8E | Boresight Pantel using Standard Angle | | NO-GO = 0 POINTS TIME ____ = ____ POINTS |
| TASK 9 | Verifying Boresight with the M140/M139 Alignment Device | | NO-GO = 0 POINTS TIME ____ = ____ POINTS |
| TASK 10A | Fire Mission | | NO-GO = 0 POINTS TIME ____ = ____ POINTS |
| TASK 10B | Fire Mission | | NO-GO = 0 POINTS TIME ____ = ____ POINTS |
| TASK 10C | Fire Mission | | NO-GO = 0 POINTS TIME ____ = ____ POINTS |

Table B-3. Recommended grading sheet (continued)

| GUNNER'S NAME | | SECTION | UNIT |
|---------------------|--|---------|---|
| SECTION CHIEF | | DATE | WEAPON SYSTEM |
| TASK | | | POINTS ACHIEVED |
| TASK 10D | Fire mission | | NO-GO = 0 POINTS TIME ____ = ____ POINTS |
| TASK 10E | Fire mission | | NO-GO = 0 POINTS TIME ____ = ____ POINTS |
| TASK 11A | Direct Fire | | NO-GO = 0 POINTS TIME ____ = ____ POINTS |
| TASK 11B | Direct Fire | | NO-GO = 0 POINTS TIME ____ = ____ POINTS |
| TASK 11C | Direct Fire | | NO-GO = 0 POINTS TIME ____ = ____ POINTS |
| TASK 11D | Direct Fire | | NO-GO = 0 POINTS TIME ____ = ____ POINTS |
| TASK 12 | Laying the Howitzer for Quadrant with the Range Quadrant | | NO-GO = 0 POINTS TIME ____ = ____ POINTS |
| TASK 13 | Measure the Quadrant with a Range Quadrant | | NO-GO = 0 POINTS TIME ____ = ____ POINTS |
| TASK 14 | Initialize the AFCS | | NO-GO = 0 POINTS TIME ____ = ____ POINTS |
| TASK 15 | Prepare for Firing Using the AFCS | | NO-GO = 0 POINTS TIME ____ = ____ POINTS |
| TASK 16 | Conduct Fire Missions Using the AFCS | | NO-GO = 0 POINTS TIME ____ = ____ POINTS |
| TASK 17 | Perform Direct Fire Using the AFCS | | NO-GO = 0 POINTS TIME ____ = ____ POINTS |
| TOTAL POINTS | | | |

B-7. TASKS

TASK 1

Laying a howitzer for initial direction of fire using the aiming circle. 061-266-2004

Conditions- Soldier is given a howitzer in the firing position with the cannon tube 50 roils off the azimuth of fire and at loading elevation (unit SOP). Bubbles will be level, and special corrections are 0 An assistant examiner will operate the aiming circle, which will be located 50 meters to the left front of the howitzer. Soldier positions himself as gunner and announces when ready. The assistant examiner commands **NUMBER 1 ADJUST, AIMING POINT THIS INSTRUMENT, DEFLECTION (XXXX)**.

Time- Time will start on the last digit of deflection of the initial command. Time will stop when the assistant examiner states that number 1 is laid.

Scoring-

a. Standards of precision (B-2) were met. (If applicable.)

b. Correct steps were followed to complete the task.

c. If steps a and b were not followed, soldier recieves a NO-GO and 0 points. If soldier received a GO on steps a and b, use the chart below to determine score.

| GO | NO-GO |
|----|-------|
| | |
| | |
| | |

| M101A1 | M102 | M118A1 | M198 | M109s | |
|-----------------|-------|--------|-------|-------|--------|
| TIME IN SECONDS | | | | | POINTS |
| -29 | -29 | -29 | -34 | -29 | 4 |
| 30-34 | 30-34 | 30-34 | 35-39 | 30-34 | 3 |
| 35-39 | 35-39 | 35-39 | 40-45 | 35-39 | 2 |
| 40-50 | 40-50 | 40-50 | 45-50 | 40-50 | 1 |
| 51- | 51- | 51- | 51- | 51- | 0 |

Score Example: (M101A1 howitzer) If the soldier performs Task 1 in 29.59 seconds, he scores 4 points. If the soldier performs Task 1 in 50.59 seconds, he scores 1 point.

TASK 2

Lay a howitzer for initial direction of fire using the M2 compass. 061-266-2003

Conditions- The soldier is given a howitzer in the firing position. The cannon tube is 50 roils off the azimuth of fire and at loading elevation (unit SOP). Bubbles will be level and special corrections at 0. An assistant examiner will be at the M2 compass located 10 meters to the left front of the howitzer. The soldier positions himself as the gunner and announces when ready. The assistant examiner commands **NUMBER 1 ADJUST, AIMING POINT THIS INSTRUMENT, DEFLECTION (XXXX)**.

Time- Time will start on the last digit of the deflection of the initial command. Time will stop when the assistant examiner announces that number 1 is laid.

Scoring-

- a. Standards of precision (B-2) were met. (If applicable.)
- b. Correct steps were followed to complete the task.
- c. If steps a and b were not followed, soldier recieves a NO-GO and 0 points. If soldier received a GO on steps a and b, use the chart below to determine score.

| GO | NO-GO |
|----|-------|
| | |
| | |
| | |

| M101A1 | M102 | M119A1 | M198 | M109s | POINTS |
|------------------------|-------|--------|-------|-------|--------|
| TIME IN SECONDS | | | | | |
| -17 | -17 | -17 | -22 | -17 | 4 |
| 18-20 | 18-20 | 18-20 | 23-25 | 18-20 | 3 |
| 21-23 | 21-23 | 21-23 | 26-28 | 21-23 | 2 |
| 24-25 | 24-25 | 24-25 | 29-30 | 24-25 | 1 |
| 26- | 26- | 26- | 31- | 26- | 0 |

TASK 3

Lay a howitzer for initial direction of fire using a distant aiming point. 061-266-2003

Conditions- Soldier is given a howitzer in firing position with the cannon tube 50 roils off the azimuth of fire and at loading elevation (unit SOP). Bubbles will be level and special corrections at 0 The soldier positions himself as gunner and announces when ready. The examiner commands **NUMBER 1 ADJUST, AIMING POINT (NAME OF OBJECT AND LOCATION), DEFLECTION (XXXX).**

Time- Time will start on the last digit of the deflection of the initial command. Time will stop when the examiner states that number 1 is laid.

Scoring-

- a. Standards of precision (B-2) were met. (If applicable.)
- b. Correct steps were followed to complete the task.
- c. If steps a and b were not followed, soldier recieves a NO-GO and 0 points. If soldier received a GO on steps a and b, use the chart below to determine score.

| M101A1 | M102 | M119A1 | M198 | M109s | |
|-----------------|-------|--------|-------|-------|--------|
| TIME IN SECONDS | | | | | POINTS |
| -17 | -17 | -17 | -22 | -17 | 4 |
| 18-20 | 18-20 | 18-20 | 23-25 | 18-20 | 3 |
| 21-23 | 21-23 | 21-23 | 26-28 | 21-23 | 2 |
| 24-25 | 24-25 | 24-25 | 29-30 | 24-25 | 1 |
| 26- | 26- | 26- | 31- | 26- | 0 |

TASK 4

Laying another howitzer reciprocally. 061-266-2002

Conditions— The soldier is given a howitzer in the firing position and already laid for initial direction of fire. Bubbles will be level and special corrections at 0. The pantel will be 50 mils off the howitzer to be laid. An assistant examiner will act as the gunner of the howitzer to be laid. The soldier positions himself as gunner and states when ready. The examiner will say BEGIN.

Time— Time will start when the examiner says BEGIN. The time will stop when the gunner says NUMBER 2 IS LAID.

Scoring-

a. Standards of precision (B-2) were met. (If applicable.)

b. Correct steps were followed to complete the task.

c. If steps a and b were not followed, soldier receives a NO-GO and 0 points. If soldier received a GO on steps a and b, use the chart below to determine score.

| GO | NO-GO |
|----|-------|
| | |
| | |
| | |

| M101A1 | M102 | M119A1 | M198 | M109s | |
|-----------------|-------|--------|-------|-------|--------|
| TIME IN SECONDS | | | | | POINTS |
| -12 | -12 | -12 | -12 | -12 | 4 |
| 13-15 | 13-15 | 13-15 | 13-15 | 13-15 | 3 |
| 16-18 | 16-18 | 16-18 | 16-18 | 16-18 | 2 |
| 19-20 | 19-20 | 19-20 | 19-20 | 19-20 | 1 |
| 21- | 21- | 21- | 21- | 21- | 0 |

TASK 5

Refer the piece. 061-266-2231

Conditions- The soldier is given a howitzer in the firing position that has already been laid for initial direction of fire. Bubbles will be level and special corrections at 0. The pantel will be oriented on the collimator. An assistant examiner will be operating the aiming circle 50 meters to the howitzer's left front. The soldier positions himself as the gunner and announces when ready, The assistant examiner commands **NUMBER 1 REFER, AIMING POINT THIS INSTRUMENT.**

Time- Time will start on the word refer. Time will stop when the last digit of deflection is announced.

Scoring-

- a. Standards of precision (B-2) were met. (If applicable.)
- b. Correct steps were followed to complete the task.
- c. If steps a and b were not followed, soldier recieves a NO-GO and 0 points. If soldier received a

| GO | NO-GO |
|----|-------|
| | |
| | |
| | |

| M101A1 | M102 | M119A1 | M198 | M109s | |
|-----------------|-------|--------|-------|-------|--------|
| TIME IN SECONDS | | | | | POINTS |
| -12 | -12 | -12 | -12 | -12 | 4 |
| 13-15 | 13-15 | 13-15 | 13-15 | 13-15 | 3 |
| 16-18 | 16-18 | 16-18 | 16-18 | 16-18 | 2 |
| 19-20 | 19-20 | 19-20 | 19-20 | 19-20 | 1 |
| 21- | 21- | 21- | 21- | 21- | 0 |

TASK 6

Aligning the collimator. 061-266-2000, 061-266-2001

Conditions- The soldier is given a howitzer in the firing position that has already been laid on the initial direction of fire. Bubbles will be level and special corrections on 0. An assistant examiner will be posted at the collimator, 4-15 meters off the howitzer's left front. The collimator will be on the tripod but will not be sighted in on the panel and will not have its legs sandbagged. The soldier positions himself as gunner and announces when ready. The examiner will say **BEGIN**.

Time- Time will start when the examiner says **BEGIN**. Time will stop when the gunner states that the collimator is set.

Scoring-

- a. Standards of precision (B-2) were met. (If applicable.)
- b. Correct steps were followed to complete the task.
- c. If steps a and b were not followed, soldier receives a NO-GO and 0 points. If soldier received a GO on steps a and b, use the chart below to determine score.

| GO | NO-GO |
|----|-------|
| | |
| | |
| | |

| M101A1 | M102 | M119A1 | M198 | M109s | |
|-----------------|-------|--------|-------|-------|--------|
| TIME IN SECONDS | | | | | POINTS |
| -17 | -17 | -17 | -22 | -17 | 4 |
| 18-20 | 18-20 | 18-20 | 23-25 | 18-20 | 3 |
| 21-23 | 21-23 | 21-23 | 26-28 | 21-23 | 2 |
| 24-25 | 24-25 | 24-25 | 29-30 | 24-25 | 1 |
| 26- | 26- | 26- | 31- | 26- | 0 |

TASK 7

Aligning the aiming posts. 061-266-2000, 061-266-2001

Conditions- The soldier is given a howitzer in the firing position that has already been laid on the initial direction of fire. Bubbles will be level and special corrections on O. The pantel will be oriented on the collimator. Aiming posts will be emplaced in the ground at 50 and 100 meters from the howitzer, but will not be aligned. An assistant examiner will be posted at the far aiming post. The soldier will position himself as gunner and announce when ready. The examiner will say **BEGIN**.

Time- The time will start when the examiner says **BEGIN**. The time will stop when the gunner states that the aiming posts are set.

Scoring-

a. Standards of precision (B-2) were met. (If applicable.)

b. Correct steps were followed to complete the task.

c. If steps **a** and **b** were not followed, soldier receives a NO-GO and 0 points. If soldier received a GO on steps **a** and **b**, use the chart below to determine score.

| M101A1 | M102 | M119A1 | M198 | M109s | |
|-----------------|-------|--------|-------|-------|--------|
| TIME IN SECONDS | | | | | POINTS |
| -17 | -17 | -17 | -22 | -17 | 4 |
| 18-20 | 18-20 | 18-20 | 23-25 | 18-20 | 3 |
| 21-23 | 21-23 | 21-23 | 26-28 | 21-23 | 2 |
| 24-25 | 24-25 | 24-25 | 29-30 | 24-25 | 1 |
| 26- | 26- | 26- | 31- | 26- | 0 |

TASK 8

Boresight the howitzer.

TASK 8A

Boresighting the howitzer (pantel) with the test target.

Conditions- The soldier is given a howitzer in the tiring position. Bubbles will be level and special corrections on 0. The pantel will be 10 mils off the test target, and the cover of the detent shaft will be on. The cannon tube will be aligned on the test target, which will be posted 50 meters in front of the howitzer. Boresight will be off by 5 mils and the soldier will be provided with the tools needed to make corrections to the sight. The soldier positions himself as gunner and states when ready. The examiner will say **BEGIN**.

Time- The time will start when the examiner says **BEGIN** and will stop when the gunner states that the howitzer is boresighted.

Scoring-

a. Standards of precision (B-2) were met. (If applicable.)

b. Correct steps were followed to complete the task.

c. If steps a and b were not followed, soldier receives a NO-GO and 0 points. If soldier received a GO on steps a and b, use the chart below to determine score.

| GO | NO-GO |
|----|-------|
| | |
| | |
| | |

| M101A1 | M102 | M109s | |
|-----------------|--------|--------|--------|
| TIME IN SECONDS | | | POINTS |
| -45 | -45 | -45 | 4 |
| 46-60 | 46-60 | 46-60 | 3 |
| 61-89 | 61-89 | 61-89 | 2 |
| 90-120 | 90-120 | 90-120 | 1 |
| 121- | 121- | 121- | 0 |

TASK 8B

Boresighting the howitzer (elbow telescope) with the test target. 061-266-2005

Conditions- The soldier is given a howitzer in the firing position. The cannon tube is aligned on the test target but the elbow telescope is not aligned on the test target. The test target will be located 50 meters in front of the howitzer, and the soldier will be given the tools needed to adjust the sight. The soldier will position himself as the gunner and announce when ready. The examiner will say **BEGIN**.

Time- The time will start when the examiner says **BEGIN** and will end when the gunner states that the howitzer is boresighted.

Scoring-

- a. Standards of precision (B-2) were met. (If applicable.)
- b. Correct steps were followed to complete the task.
- c. If steps a and b were not followed, soldier receives a NO-GO and 0 points. If soldier received a GO on steps a and b, use the chart below to determine score.

| GO | NO-GO |
|----|-------|
| | |
| | |
| | |

| M101A1 | M102 | M109s | |
|-----------------|--------|--------|--------|
| TIME IN SECONDS | | | POINTS |
| -45 | -45 | -45 | 4 |
| 46-60 | 46-60 | 46-60 | 3 |
| 61-89 | 61-89 | 61-89 | 2 |
| 90-120 | 90-120 | 90-120 | 1 |
| 121- | 121- | 121- | 0 |

TASK 8C

Boresighting the howitzer (pantel) using a DAP. 061-266-2005

Conditions- The soldier will be given a howitzer in the firing position. Bubbles will be level and special corrections on 0. The cannon tube will be aligned on the DAP, but the pantel will be aligned 10 mils off the DAP. Boresight will be 5 mils off, and the cover will be on the detent shaft (if applicable). The soldier will be given the tools needed to adjust the sight. The soldier positions himself and announces when ready. The examiner will say **BEGIN**.

Time- The time will start when the examiner says **BEGIN**, and will stop when the gunner states that the howitzer is boresighted.

Scoring-

- a. Standards of precision (B-2) were met. (If applicable.)
- b. Correct steps were followed to complete the task.
- c. If steps a and b were not followed, soldier receives a NO-GO and 0 points. If soldier received a GO on steps a and b, use the chart below to determine score.

| GO | NO-GO |
|----|-------|
| | |
| | |
| | |

| M101A1 | M102 | M119A1 | M198 | M109s | |
|-----------------|--------|--------|--------|--------|--------|
| TIME IN SECONDS | | | | | POINTS |
| -45 | -45 | -45 | -45 | -45 | 4 |
| 46-60 | 46-60 | 46-60 | 46-60 | 46-60 | 3 |
| 61-89 | 61-89 | 61-89 | 61-89 | 61-89 | 2 |
| 90-120 | 90-120 | 90-120 | 90-120 | 90-120 | 1 |
| 121- | 121- | 121- | 121- | 121- | 0 |

TASK 8D

Boresight the howitzer (elbow telescope) using a DAP.

Conditions- The soldier will be given a howitzer in the firing position. The cannon tube will be aligned on the DAP, but the elbow telescope will not be aligned on the DAP. The soldier will be provided with the tools needed to adjust the sight. The soldier positions himself as assistant gunner and announces when ready. The examiner will say BEGIN.

Time- The time will start when the examiner says BEGIN, and will stop when the assistant gunner states that the howitzer is boresighted.

Scoring-

a. Standards of precision (B-2) were met. (If applicable.)

b. Correct steps were followed to complete the task.

c. If steps a and b were not followed, soldier receives a NO-GO and 0 points. If soldier received a GO on steps a and b, use the chart below to determine score.

| GO | NO-GO |
|----|-------|
| | |
| | |
| | |

| M101A1 | M102 | M198 | M109s | |
|-----------------|--------|--------|--------|--------|
| TIME IN SECONDS | | | | POINTS |
| -45 | -45 | -45 | -45 | 4 |
| 46-60 | 46-60 | 46-60 | 46-60 | 3 |
| 61-89 | 61-89 | 61-89 | 61-89 | 2 |
| 90-120 | 90-120 | 90-120 | 90-120 | 1 |
| 121- | 121- | 121- | 121- | 0 |

TASK 8E

Boresighting the howitzer (pantel) using standard angle.

Conditions- The soldier is given a howitzer in the firing position which has level bubbles and special corrections on 0. The cannon tube will be at 0 mils elevation. A parallex shield, screwdrivers, and a standard angle deflection and elevation will be provided. The soldier positions himself as gunner and announces when ready. The examiner will say **BEGIN**.

Time- The time will start when the examiner says **BEGIN**, and stop when the gunner states that the howitzer is boresighted.

| M101A1 | |
|-----------------|--------|
| TIME IN SECONDS | POINTS |
| -45 | 4 |
| 46-60 | 3 |
| 61-89 | 2 |
| 90-120 | 1 |
| 121- | 0 |

Scoring-

- a. Standards of precision (B-2) were met. (If applicable.)
- b. Correct steps were followed to complete the task.
- c. If steps a and b were not followed, soldier receives a NO-GO and 0 points. If soldier received a GO on steps a and b, use the chart below to determine score.

| GO | NO-GO |
|----|-------|
| | |
| | |
| | |

TASK 9

Verifying boresight with the M140/M139 alignment device.
061-266-2239

Conditions- The soldier is given a howitzer in the firing position, with level bubbles and special corrections on 0. The cannon tube will be set at 0 mils elevation, and the azimuth counter will be set at 1600. The soldier will be provided with an M 140/M139 alignment device. The soldier positions himself as gunner and announces when ready. The examiner will say **BEGIN**.

Time- The time will start when the examiner says **BEGIN**, and will stop when the gunner states that boresight is either verified or not verified.

Scoring-

a. Standards of precision (B-2) were met. (If applicable.)

b. Correct steps were followed to complete the task.

c. If steps a and b were not followed, soldier receives a NO-GO and 0 points. If soldier received a GO on steps a and b, use the chart below to determine score.

| GO | NO-GO |
|----|-------|
| | |
| | |
| | |

| M102 | M119A1 | M198 | M109s | |
|------------------------|--------|-------|-------|---------------|
| TIME IN SECONDS | | | | POINTS |
| -17 | -17 | -17 | -17 | 4 |
| 18-20 | 18-20 | 18-20 | 18-20 | 3 |
| 21-23 | 21-23 | 21-23 | 21-23 | 2 |
| 24-25 | 24-25 | 24-25 | 24-25 | 1 |
| 26- | 26- | 26- | 26- | 0 |

TASK 10

Fire missions (the missions in task 10 are one continuous mission).

TASK 10A

Conditions- The soldier is given a howitzer in the firing position. The howitzer is laid and both the collimator and aiming posts are emplaced. The pantel is aligned on the collimator, bubbles are level, and special corrections are at 0. The cannon tube is oriented on the primary direction of fire and elevated to 315 mils. The soldier positions himself as gunner and announces when ready. The examiner commands **FIRE MISSION, PLATOON ADJUST, NUMBER 1, 1 ROUND, SHELL HE, CHARGE (XX), FUZE QUICK, DEFLECTION 3225 (M101A1 USE DEFLECTION 2825), QUADRANT 315.**

Time- The time will start on the last digit of the deflection and will stop when the gunner says **READY.**

Scoring-

- a. Standards of precision (B-2) were met. (If applicable.)
- b. Correct steps were followed to complete the task.
- c. If steps a and b were not followed, soldier receives a NO-GO and 0 points. If soldier received a GO on steps a and b, use the chart below to determine score.

| GO | NO-GO |
|----|-------|
| | |
| | |
| | |

| M101A1 | M102 | M119A1 | M198 | M109s | |
|------------------------|-------|--------|-------|-------|---------------|
| TIME IN SECONDS | | | | | POINTS |
| -10 | -10 | -10 | -10 | -8 | 4 |
| 11-12 | 11-12 | 11-12 | 11-12 | 9-10 | 3 |
| 13-14 | 13-14 | 13-14 | 13-14 | 11-12 | 2 |
| 15-16 | 15-16 | 15-16 | 15-16 | 13-14 | 1 |
| 17- | 17- | 17- | 17- | 15- | 0 |

TASK 10B

Conditions- Continuation from 10A. Soldier announces when ready. The examiner commands **SPECIAL CORRECTIONS, RIGHT 4, DEFLECTION 3194 (M101A1 USE DEFLECTION 2794), QUADRANT 315.**

Time- The time will start on the last digit of deflection and will stop when the gunner states **READY.**

Scoring-

a. Standards of precision (B-2) were met. (If applicable.)

b. Correct steps were followed to complete the task.

c. If steps a and b were not followed, soldier receives a NO-GO and 0 points. If soldier received a GO on steps a and b, use the chart below to determine score.

| GO | NO-GO |
|----|-------|
| | |
| | |
| | |

| M101A1 | M102 | M119A1 | M198 | M109s | |
|-----------------|-------|--------|-------|-------|--------|
| TIME IN SECONDS | | | | | POINTS |
| -11 | -11 | -11 | -11 | -9 | 4 |
| 12-13 | 12-13 | 12-13 | 12-13 | 10-11 | 3 |
| 14-15 | 14-15 | 14-15 | 14-15 | 12-13 | 2 |
| 16-17 | 16-17 | 16-17 | 16-17 | 14-15 | 1 |
| 18- | 18- | 18- | 18- | 16- | 0 |

TASK 10C

Conditions- Continuation from 10B. Soldier announces when ready. The examiner cancels special corrections, says that the collimator has fallen down and directs the gunner to use the aiming posts. The examiner commands **DEFLECTION 3180 (M101A1 USE DEFLECTION 2780), QUADRANT 315.**

Time- The time will start on the last digit of deflection and will stop when the gunner states **READY.**

Scoring-

a. Standards of precision (B-2) were met. (If applicable.)

b. Correct steps were followed to complete the task.

c. If steps a and b were not followed, soldier receives a NO-GO and 0 points. If soldier received a GO on steps a and b, use the chart below to determine score.

| GO | NO-GO |
|----|-------|
| | |
| | |
| | |

| M101A1 | M102 | M119A1 | M198 | M109s | |
|------------------------|-------|--------|-------|-------|---------------|
| TIME IN SECONDS | | | | | POINTS |
| -12 | -12 | -14 | -14 | -10 | 4 |
| 13-14 | 13-14 | 15-16 | 15-16 | 11-12 | 3 |
| 15-16 | 15-16 | 17-18 | 17-18 | 13-14 | 2 |
| 17-18 | 17-18 | 19-20 | 19-20 | 15-16 | 1 |
| 19- | 19- | 21- | 21- | 17- | 0 |

TASK 10 D

Conditions- Continuation from 10C. Soldier announces when ready. The examiner commands **DEFLECTION 3230 (M101A1 USE DEFLECTION 2830), QUADRANT 315.**

Time- The time will start on the last digit of deflection and will stop when the gunner states **READY.**

Scoring-

a. Standards of precision (B-2) were met. (If applicable.)

b. Correct steps were followed to complete the task.

c. If steps a and b were not followed, soldier receives a NO-GO and 0 points. If soldier received a GO on steps a and b, use the chart below to determine score.

| GO | NO-GO |
|----|-------|
| | |
| | |
| | |

| M101A1 | M102 | M119A1 | M198 | M109s | |
|------------------------|-------|--------|-------|-------|---------------|
| TIME IN SECONDS | | | | | POINTS |
| -11 | -11 | -11 | -11 | -9 | 4 |
| 12-13 | 12-13 | 12-13 | 12-13 | 10-11 | 3 |
| 14-15 | 14-15 | 14-15 | 14-15 | 12-13 | 2 |
| 16-17 | 16-17 | 16-17 | 16-17 | 14-15 | 1 |
| 18- | 18- | 18- | 18- | 16- | 0 |

TASK 10E

Conditions- Continuation from 10D. The soldier announces when ready. The examiner commands **GAS (waits for the soldier to mask)**, **DEFLECTION 3242 (M101A1 use deflection 2842)**, **QUADRANT 315**.

Time- The time starts on the last digit of deflection and stops when the gunner states **READY**.

Scoring-

- a. Standards of precision (B-2) were met. (If applicable.)
- b. Correct steps were followed to complete the task.
- c. If steps a and b were not followed, soldier receives a NO-GO and 0 points. If soldier received a GO on steps a and b, use the chart below to determine score.

| GO | NO-GO |
|----|-------|
| | |
| | |
| | |

| M101A1 | M102 | M119A1 | M198 | M109s | POINTS |
|------------------------|-------|--------|-------|-------|--------|
| TIME IN SECONDS | | | | | |
| -11 | -11 | -11 | -11 | -9 | 4 |
| 12-13 | 12-13 | 12-13 | 12-13 | 10-11 | 3 |
| 14-15 | 14-15 | 14-15 | 14-15 | 12-13 | 2 |
| 16-17 | 16-17 | 16-17 | 16-17 | 14-15 | 1 |
| 18- | 18- | 18- | 18- | 16- | 0 |

TASK 11

Direct fire. 061-266-2235

The fire mission in task 11 is one continuous mission. The central or reticle method of sighting may be used. Only the one man/one sight technique of direct fire will be used.

TASK 11A

Conditions- The soldier is given a howitzer in the firing position. The howitzer is laid and the panel is oriented on the collimator. Bubbles are level and special corrections at 0. The cannon tube is at 0 mils elevation and is oriented so that the trails will not have to be shifted during the mission to engage the direct fire target. The soldier will be told which direct fire target he is to engage. The soldier positions himself as gunner and announces when ready. The examiner commands **FIRE MISSION, TARGET THAT (XXX), (direction), SHELL HE, CHARGE (XX), FUZE QUICK, LEAD RIGHT 15 MILS, RANGE 600, FIRE AT WILL.**

Time- The time will start when the examiner states **FIRE AT WILL** and will stop when the gunner says **FIRE.**

Scoring-

a. Standards of precision (B-2) were met. (If applicable.)

b. Correct steps were followed to complete the task.

c. If steps a and b were not followed, soldier receives a NO-GO and 0 points. If soldier received a GO on steps a and b, use the chart below to determine score.

| GO | NO-GO |
|----|-------|
| | |
| | |
| | |

| M101A1 | M102 | M119A1 | M198 | M109s | |
|-----------------|-------|--------|-------|-------|--------|
| TIME IN SECONDS | | | | | POINTS |
| -11 | -11 | -11 | -11 | -9 | 4 |
| 12-13 | 12-13 | 12-13 | 12-13 | 10-11 | 3 |
| 14-15 | 14-15 | 14-15 | 14-15 | 12-13 | 2 |
| 16-17 | 16-17 | 16-17 | 16-17 | 14-15 | 1 |
| 18- | 18- | 18- | 18- | 16- | 0 |

TASK IIB

Conditions- Continuation from 11A. Soldier announces when ready. The examiner commands **RIGHT 5, ADD 100**.

Time- The time will start when the examiner states **ADD 100** and will stop when the gunner says **FIRE**.

Scoring-

a. Standards of precision (B-2) were met. (If applicable.)

b. Correct steps were followed to complete the task.

c. If steps a and b were not followed, soldier receives a NO-GO and 0 points. If soldier received a GO on steps a and b, use the chart below to determine score.

| GO | NO-GO |
|----|-------|
| | |
| | |
| | |

| M101A1 | M102 | M119A1 | M198 | M109s | |
|------------------------|-------|--------|-------|-------|---------------|
| TIME IN SECONDS | | | | | POINTS |
| -6 | -6 | -6 | -6 | -4 | 4 |
| 7-8 | 7-8 | 7-8 | 7-8 | 5-6 | 3 |
| 9-10 | 9-10 | 9-10 | 9-10 | 7-8 | 2 |
| 11-12 | 11-12 | 11-12 | 11-12 | 9-10 | 1 |
| 13- | 13- | 13- | 13- | 11- | 0 |

TASK IIC

Conditions- Continuation of task IIB. The soldier announces when ready. The examiner commands **LEFT 10, ADD 100**.

Time- The time starts when the examiner states **ADD 100** and stops when the gunner states **FIRE**.

Scoring-

a. Standards of precision (B-2) were met. (If applicable.)

b. Correct steps were followed to complete the task.

c. If steps a and b were not followed, soldier receives a NO-GO and 0 points. If soldier received a GO on steps a and b, use the chart below to determine score.

| GO | NO-GO |
|----|-------|
| | |
| | |
| | |

| M101A1 | M102 | M119A1 | M198 | M109s | |
|-----------------|-------|--------|-------|-------|--------|
| TIME IN SECONDS | | | | | POINTS |
| -6 | -6 | -6 | -6 | -4 | 4 |
| 7-8 | 7-8 | 7-8 | 7-8 | 5-6 | 3 |
| 9-10 | 9-10 | 9-10 | 9-10 | 7-8 | 2 |
| 11-12 | 11-12 | 11-12 | 11-12 | 9-10 | 1 |
| 13- | 13- | 13- | 13- | 11- | 0 |

TASK 11D

Conditions- Continuation from task 11C. The soldier announces when ready. The examiner commands **LEFT 15, DROP 100**.

Time- The time will start when the examiner states **DROP 100** and will stop when the gunner states **FIRE**.

Scoring-

a. Standards of precision (B-2) were met. (If applicable.)

b. Correct steps were followed to complete the task.

c. If steps a and b were not followed, soldier receives a NO-GO and 0 points. If soldier received a GO on steps a and b, use the chart below to determine score.

| GO | NO-GO |
|----|-------|
| | |
| | |
| | |

| M101A1 | M102 | M119A1 | M198 | M109s | |
|-----------------|-------|--------|-------|-------|--------|
| TIME IN SECONDS | | | | | POINTS |
| -6 | -6 | -6 | -6 | -4 | 4 |
| 7-8 | 7-8 | 7-8 | 7-8 | 5-6 | 3 |
| 9-10 | 9-10 | 9-10 | 9-10 | 7-8 | 2 |
| 11-12 | 11-12 | 11-12 | 11-12 | 9-10 | 1 |
| 13- | 13- | 13- | 13- | 11- | 0 |

TASK 12

Lay a howitzer for quadrant with the range quadrant.

Conditions- The soldier is given a howitzer in the firing position with the cannon tube at 0 mils elevation. Bubbles will be level and special corrections at 0 mils. The soldier positions himself as assistant gunner/gunner and announces when ready. The examiner commands **QUADRANT 215**.

Time- The time will start when the examiner states **QUADRANT 215** and will stop when the assistant gunner/gunner states **SET**.

Scoring-

- a. Standards of precision (B-2) were met. (If applicable.)
- b. Correct steps were followed to complete the task.
- c. If steps a and b were not followed, soldier receives a NO-GO and 0 points. If soldier received a GO on steps a and b, use the chart below to determine score.

| GO | NO-GO |
|----|-------|
| | |
| | |
| | |

| M101A1 | M102 | M119A1 | M198 | M109s | |
|------------------------|-------|--------|-------|-------|---------------|
| TIME IN SECONDS | | | | | POINTS |
| -9 | -9 | -9 | -9 | -8 | 4 |
| 10-11 | 10-11 | 10-11 | 10-11 | 9-10 | 3 |
| 12-13 | 12-13 | 12-13 | 12-13 | 11-12 | 2 |
| 14-15 | 14-15 | 14-15 | 14-15 | 13-14 | 1 |
| 16- | 16- | 16- | 16- | 15- | 0 |

TASK 13

Measure the quadrant using the range quadrant.

Conditions- The soldier is given a howitzer in the firing position, with the cannon tube at 245 mils. The range quadrant is at 0 mils and the cross level bubble is centered. The soldier positions himself as the assistant gunner/gunner and announces when ready. The examiner states **BEGIN**.

Time- The time will start when the examiner states **BEGIN** and will stop when the assistant gunner/gunner states **QUADRANT 245**.

Scoring-

- a. Standards of precision (B-2) were met. (If applicable.)
- b. Correct steps were followed to complete the task.
- c. If steps a and b were not followed, soldier receives a NO-GO and 0 points. If soldier received a GO on steps a and b, use the chart below to determine score.

| M101A1 | M102 | M119A1 | M198 | M109s | |
|-----------------|-------|--------|-------|-------|--------|
| TIME IN SECONDS | | | | | POINTS |
| -9 | -9 | -9 | -9 | -8 | 4 |
| 10-11 | 10-11 | 10-11 | 10-11 | 9-10 | 3 |
| 12-13 | 12-13 | 12-13 | 12-13 | 11-12 | 2 |
| 14-15 | 14-15 | 14-15 | 14-15 | 13-14 | 1 |
| 16- | 16- | 16- | 16- | 15- | 0 |

TASK 14

Initialize the AFCS.

Conditions- The soldier is given a howitzer parked within 1 meter of a survey control point (SCP). The soldier will receive data for the SCP and initialization data. The soldier positions himself as chief of section and announce when ready. The examiner will state **BEGIN**.

Time- The time starts when the examiner states **BEGIN** and stops when the soldier announces **INITIALIZED**.

| M109A6 | |
|------------------------|---------------|
| TIME IN MINUTES | POINTS |
| -7 | 4 |
| 8-13 | 3 |
| 14-15 | 2 |
| 16-17 | 1 |
| 18- | 0 |

Scoring-

- a. Standards of precision (B-2) were met. (If applicable.)
- b. Correct steps were followed to complete the task.
- c. If steps a and b were not followed, soldier receives a NO-GO and 0 points. If soldier received a GO on steps a and b, use the chart below to determine score.

| GO | NO-GO |
|-----------|--------------|
| | |
| | |
| | |

TASK 15

Prepare for firing using the AFCS.

Conditions- The soldier is given a howitzer, aligned along the azimuth of fire, and in travel lock. The “Emplace” screen is displayed on the AFCS. The soldier positions himself as the chief of section and announces when ready. The examiner will state **BEGIN**.

Time- The time will start when the examiner states **BEGIN** and will stop when the soldier sends the updated piece status.

| M109A6 | |
|-----------------|--------|
| TIME IN MINUTES | POINTS |
| -1:30 | 4 |
| 1:31-1:45 | 3 |
| 1:46-1:55 | 2 |
| 1:56-2:10 | 1 |
| 2:11- | 0 |

Scoring-

a. Standards of precision (B-2) were met. (If applicable.)

b. Correct steps were followed to complete the task.

c. If steps a and b were not followed, soldier receives a NO-GO and 0 points. If soldier received a GO on steps a and b, use the chart below to determine score.

| GO | NO-GO |
|----|-------|
| | |
| | |
| | |

TASK 16

Conduct a fire mission using the AFCS.

Conditions- The soldier is given a howitzer at loading elevation. The soldier positions himself as the chief of section and announces when ready. The examiner has a digital call for fire transmitted to the AFCS.

Time- The time starts when the fire mission is received at the AFCS and stops when the howitzer is laid on the target.

| M109A6 | |
|-----------------|--------|
| TIME IN SECONDS | POINTS |
| -15.0 | 4 |
| 15.1-16.0 | 3 |
| 16.1-20.0 | 2 |
| 20.1-22.0 | 1 |
| 22.1- | 0 |

Scoring-

- a. Standards of precision (B-2) were met. (If applicable.)
- b. Correct steps were followed to complete the task.
- c. If steps a and b were not followed, soldier receives a NO-GO and 0 points. If soldier received a GO on steps a and b, use the chart below to determine score.

| GO | NO-GO |
|----|-------|
| | |
| | |
| | |

TASK 17

Perform direct fire using the AFCS.

Conditions- The soldier is given a howitzer, aligned on the azimuth of fire, and out of travel lock. The soldier is shown which target he is to engage and an assistant examiner will be provided to lay for deflection. The soldier positions himself as the chief of section and announces when ready. The examiner will state **BEGIN**.

Time- The time will start when the examiner says **BEGIN** and will stop when the soldier states **SET**.

Scoring-

a. Standards of precision (B-2) were met. (If applicable.)

b. Correct steps were followed to complete the task.

c. If steps a and b were not followed, soldier receives a NO-GO and 0 points. If soldier received a GO on steps a and b, use the chart below to determine score.

| GO | NO-GO |
|----|-------|
| | |
| | |
| | |

| M109A6 | |
|-----------------|--------|
| TIME IN SECONDS | POINTS |
| -20.0 | 4 |
| 20.1-22.0 | 3 |
| 22.1-23.0 | 2 |
| 23.1-30.0 | 1 |
| 30.1- | 0 |

APPENDIX C

SAMPLE OPERATIONS CHECKLISTS

C-1. DESCRIPTION

To make a tentative plan, the commander must gather information by focusing on the battery level METT-T. Table C-1 will assist the commander in this effort.

Table C-1. **Battery FA support plan checklist**

From the S2:

1. Position Area Terrain and Weather
 - What is the slope, soil conditions, trafficability?
 - Where can I best position observation posts?
 - Site to crest or intervening crest problems?
 - Percent illumination, moonrise, moonset, night vision device window?
 - Precipitation, wind, temperature?
2. Enemy
 - What is the primary enemy threat to the battery?
 - What kind of forces?
 - Number and type of weapons?
 - Avenues of approach/how will they locate me (direction finding radar, observation)?
 - What is their mission/how will they react?
 - When and where will they be a threat?
 - When will I be his priority target?
 - When and where will he use chemical weapons (type, effects, best defense)?

From the S3:

- What battalion critical fire support tasks are my responsibility (in priority)?
- Who am I reinforcing/who do I reinforce?
- How much ammunition do I need?
- When and how will I get this ammunition?
- Observer call sign, frequency, MULE, GVLDD, OBCO?
- When will the task be executed/trigger points/frequency?
- Where are the positions I must fire from and are they clear?

- What are adjacent units' call sign, frequency, and actions?
- What is my movement priority, approved routes?
- What event triggers my movement?

C-2. PRECOMBAT CHECKLISTS

Tables C-2 through C-11 provide sample precombat checklists (PCC) for cannon mission and survivability preparations a battery will execute. By incorporating some version of these sample PCCs into a battery SOP, the commander will have preparation steps to specify to subordinates based on METT-T. With precombat checklists in the hands of all battery leaders, the commander can more efficiently communicate exactly what must be done. For example, it is easier to direct the section to complete the copperhead PCC than to individually specify all the subtasks required.

Table C-2. **Air threat PCC**

Sections:

- Set M2 .50 cal MG headspace and timing
- Clean M2 .50 cal MG
- Test fire M2 .50 cal MG
- Practice changing M2 barrels
- Practice stoppage and immediate action drills
- Review aircraft threat cards
- Review battery air attack signals
- Check camouflage
 - Nets serviceable/cover vehicles
 - Windshields, lights covered
 - Net off M2 .50 cal MGs
- Verify ADA warning/WCS
- Verify signal flags are on hand
- Orient air guards IAW SOP
- Rehearse ADA movement drills
- Report completion/status to plt sgt/plt ldr
- Function check

Table C-2. Air threat PCC (Continued)

Platoon:

- Assign air sectors of fire
- Establish air TRPs
- Verify coverage on defense diagram
- Disseminate ADA warning/WCS
- Conduct air attack rehearsal
- Conduct Medevac PCC
- Assign air avenues of approach
- Maximize dispersion
- Coordinate for ADA coverage with the battery TOC for small arms ammo authorization

Table C-3. Counterfire PCC

Sections:

- Survivability positions dug for all personnel with overhead cover
- Verify and recon alt positions and route
- Sandbag collimator and bury wire
- ID and train crater analysis team
- Rehearse hasty displace drill
- Rehearse hasty occupation
- Check camouflage, if visual threat
 - Nets serviceable/cover vehicles
 - Windshields/lights covered
- Inventory aid back/litters
- Minimize the equipment on the ground
- Report completion/status to plt sgt/plt ldr

Platoon:

- Maximize dispersion
- Position in defilade, and avoid high angle
- Request engineer support
- ID immediate action status
- ID volley to move criteria
- Fully prepare alt positions
- Request critical fire zone for battery
- Conduct Medevac PCC
- Rehearse hasty displacement and occupation
- Check Class IV on hand

Table C-4. NBC PCC

Sections:

- M291 kits on hand, if available
- M256 kits on hand
- M11/M13 DAPs on hand
- Masks and hoods fitted and checked
- MOPP gear inventoried and accessible
- All nonessential equipment stowed and covered
- Survey teams identified and rehearsed
- Antidote kits on hand
- Rehearse buddy aid procedures
- Review hasty decon procedures
- Report completion or problems to plt sgt/plt ldr
- Unmasking procedures

Platoon:

- PMCS and emplace M8 alarms
- Rehearse NBC reaction drill and teams
- Check BOC plotting CMDs and reporting NBC hazard sites to all leaders
- Rehearse contaminated Medevac
- Coordinate deliberate decon plan with battalion
- Map with dirty routes in Medevac vehicles
- Check BOC has all MOPP sizes for reorder
- Extra filters and expendable NBC supplies on hand
- M9 paper
- Hasty decon team identified

Table C-5. Artillery raid PCC

Section:

- Ammunition loaded IAW mission
- Conduct map recon of routes and positions
- Brief route to all personnel
- Recovery plan briefed and understood
- Targets briefed and rehearsed with FDC
- All vehicle fuel tanks topped off
- Conduct PMCS on vehicles and howitzers
- Movement formation plan rehearsed
- Do threat PCC for likely threat
- Check all NVGs, night sights, and lighting devices (in section color)
- Report completion or problems to the plt sgt/plt ldr

Platoon:

- Recon (at least by map) route and position and brief leader's plan in detail
- IPB of position with the S2
- Verify recovery plan
- Rehearse Medevac plan
- Take mission-essential vehicles only
- Verify survey plan for unit and radar
- Plan and track required logistical support
- Rehearse security plan
- Rehearse action on the objective

Table C-6. Copperhead (CPHD) PCC

| |
|--|
| <p>Section:</p> <ul style="list-style-type: none"> • Cphd trainer on hand • Execute dry fire mission and round inspection IAW plt ldr's time line • Inspect CPHD IAW -10 • Verify and record powder temperature IAW plt ldr's time line • Set up M90 to capture MVV--receive expected MV from FDC • Verify PRF code with FDC • Rehearse extraction procedures, and check equipment • Report completion or problems to plt sgt/plt ldr <p>FDC:</p> <ul style="list-style-type: none"> • Establish Cphd time line from trainer rehearsal to RFT time • "Bump" BCS to BCS ASAP...reverify after met or other changes • Verify PRF code with observer • Verify angle T is less than 800 mils • Confirm observer location • Verify GT range is less than 16,400 meters • Check OT range is less than 5,000 meters (stationary) or 3,500 meters (moving) • Check prop temp by comparing with prop temp across the gun line • Compute manual MVV for Cphd from DA Form 2408-4 and the FT 155-AS-1 • Check met schedule against planned hit time to have current met and time to rebump data • Conduct tech rehearsal with observer |
|--|

Table C-7. FASCAM PCC

| |
|--|
| <p>Section:</p> <ul style="list-style-type: none"> • FASCAM distributed IAW guidance report number of RAMMs and ADAMs • Correct fuzes and powders on hand, lots reported to FDC • Ammo loaded IAW plan: shoot from ground, ammo vehicle, or gun? • Conduct full-up rehearsal • Be prepared to move out if survival move planned • Report completion or problems to plt sgt/plt ldr <p>FDC:</p> <ul style="list-style-type: none"> • Receive/compute aimpoints • Direct ammo breakdown by gun, and verify • Conduct full-up technical rehearsal, report rehearsal time to battalion S3 • Plot aimpoints on chart, and verify • Cancel TGPCs, if applied <p>Platoon or Battery:</p> <ul style="list-style-type: none"> • Prepare alternate position completely • Brief immediate action status |
|--|

Table C-8. Massing PCC

| |
|---|
| <p>Section:</p> <ul style="list-style-type: none"> • Ammo distribution IAW FDC guidance. Report number of rounds by lot • Correct fuzes and powders on hand and reported to the FDC • Ammo loaded IAW plan and segregated by lot • Conduct full-up rehearsal • Measure and report powder temperature of massing lot every 30 minutes. • Rehearse changing aiming reference points • Store massing ammo uniformly • Verify boresight • GDU hooked up and tested • Problems with above items reported <p>FDC:</p> <ul style="list-style-type: none"> • Determine ammo requirements • Direct ammo breakdown by gun and lot, verify with plt ldr/plt sgt • Conduct full-up technical rehearsal, report times to S3/FDO • Compensate for all nonstandard conditions, meet five requirements for accurate predicted fire • GDU dry missions conducted <p>Platoon/Battery:</p> <ul style="list-style-type: none"> • Prepare alternate positions completely • Brief immediate action status • Survey-in positions and guns • Verify uniform storage of massing lots |
|---|

Table C-9. Mounted ground threat PCC

| |
|---|
| <p>Section:</p> <ul style="list-style-type: none"> • Sector marked (day or night) for crew-served weapons and howitzers • Measure/obtain ranges to dead space, key terrain, TRPs • Sight and compute data to TRPs from all weapons • Complete range cards for crew served weapons, howitzers • Rehearse direct fire crew drill • Plan Killer jJunior for dead space • PMCS/functions check all weapons • PMCS/functions check all night sights/NVGs • Ammunition on hand for all weapons • Fighting positions complete with overhead cover/section stakes • Review threat vehicle identification • Verify boresight • Report completion to the plt sgt/plt ldr <p>Platoon:</p> <ul style="list-style-type: none"> • Position weapons to cover enemy avenues of approach |
|---|

Table C-9. Mounted ground threat PCC (continued)

- Establish battery engagement areas with triggers and TRPs
- ID natural TRPs or emplace TRPs with PLGRs
- FDC computes range and azimuth to each TRP
- FDC computes self-illumination targets
- Position weapons to maximize fires in engagement areas
- Rehearse tank killer teams and reaction forces
- Rehearse Medevac (see Medevac PCC)
- LP/OP established

Table C-10. Dismounted Threat PCC

Same as Table C-9 except:

Platoon:

- Use formation to maximize perimeter security
- Use defensive wire
- Focus on 360 degree security
- Use patrolling
- ID dead space

Table C-11. Medevac PCC

Section:

- Combat lifesaver bags inventoried
- Casualty collection point identified and briefed
- Litters located and cross-loaded
- Straps and tiedowns with the litters

Table C-11. Medevac PCC (Continued)

- Verify communications with BOC
- Verify battle roster for all personnel
- Casualty forms filled out and in aid pouch
- Rehearse buddy aid procedures
- Account for section personnel in and out of position
- Report completion or problems to the plt sgt/plt ldr

Platoon:

- Rehearse Medevac in each position
- ID BOC representative to collect battle roster at CCP
- Conduct comm checks with bn and Medevac vehicle
- Ensure BOC updates and disseminates all active aid stations to leaders
- Ensure map in Medevac vehicle
- Recon/time route to aid stations
- Medic bag inventoried
- Medic has consolidated Class VIII requirements from section
- Med frequency
- Medevac procedures rehearsed

C-3 BATTERY STATUS INVENTORY

Table C-12 is a sample battery status inventory. It should be completed prior to the battalion order brief. The commander will readily know if he can support his tasks or what additional material is required.

Table C-12. Sample mission analysis worksheet/assets available

| BATTERY STATUS | AUTHORIZED | OPERATIONAL | STATUS/REMARKS |
|---------------------|------------|-------------|----------------|
| Howitzers | | | |
| Ammo Vehicles | | | |
| FDC/GEN | | | |
| Wheeled Vehicles | | | |
| GDUs | | | |
| Voice Comm | | | |
| Digital Comm | | | |
| Crew-Served Weapons | | | |
| | | | |
| | | | |

| BATTERY STATUS | AUTHORIZED | OPERATIONAL | STATUS/REMARKS |
|----------------|------------|-------------|----------------|
| Personnel | | | |
| Class I | | | |
| Class II | | | |
| Class III | | | |
| Class IV | | | |
| Class V | | | |
| Class IX | | | |
| | | | |
| | | | |

C-4. CRITICAL EVENTS TIME LINE

Table C-13 is an example time line of critical events to determine how much time is available and to schedule the battery's preparation for combat. Remember to schedule appropriate events during daylight that are difficult to conduct at night, if time permits.

C-5. BATTERY WARNING ORDER

Table C-14, page C-6, is a sample battery warning order to focus the commander's initial mission preparation and to allow his unit to begin preparation even before completing the plan. A good warning order directs actions rather than simply passing information.

Table C-13. Sample time line

| |
|--|
| <p>Critical Events:</p> <ul style="list-style-type: none"> • Bn brief • Rehearsal • BC's recon/survey linkup • Advance party ready to roll • Battery warning order • PCCs complete • IPRTF/FIRECAP (NLT) • Move (NET) • Move (NLT) • R3P/LOGPAC |
|--|

Table C-14. **Sample battery warning order (WARNO)**

Situation:

Enemy: Reg/bde faces the following enemy forces:

Size:

Current threat: air, ground, recon

Future:

Friendly: Reg/bde offense/defense, LD or ready to defend DTG_____

FA bn critical fire support tasks (CFST):

Task

- 1.
- 2.
- 3.
- 4.
- 5.

Battery Mission:

Execution:

Battery critical fire support tasks (CFST):

Task

- 1.
- 2.
- 3.
- 4.
- 5.

Conduct the following PCCs in priority:

Complete NLT:_____

- 1.
- 2.
- 3.
- 4.
- 5.

Table C-14. Sample battery warning order (WARNO) (continued)

Movement Instructions:

Time line of critical events

- Time now
- Rehearsal and location: _____
- FA rehearsal and location: _____
- Issue battery order, time/location: _____
- Technical rehearsal, time/frequency: _____
- PCC completed NLT
- Fire support rehearsal, time/frequency: _____
- Advanced party ready to move
- BC's reconnaissance
- Main body moves (NET): _____ move (NLT): _____
- R3P
- IPRTF/FIRECAP
- PCI completed NLT _____

Service Support: Time critical resupply ops.

Classes of supply:

- Class I:
- Class III:
- Class IV:
- Class V:
- Class IX:
- R3P:

Ammunition required:

Coordinate for external support (attachments/detachments of CSS assets):

Command and Signal:

C-6. BATTERY ORDER

Table C-15 is a sample battery order. Once the commander has completed his plan, he must ensure the sections retain the minimum essential information. One successful technique is the section fill-in-the-blank order. Section chiefs and other key leaders can use a laminated format to fill in during the commander's orders brief. It also helps the section chief brief his subordinates. More importantly, it forces the commander to focus on battery level-information only.

Table C-15. **Sample battery fill-in-the-blank order**

1. Situation:

Enemy:

- A. The enemy forces the reg/bde is now fighting
- B. The primary threat to the battery now
- C. The threat will be _____ NET/NLT

Friendly:

- A. The reg/bde mission: (attacking/defending)
- B. The FA bn mission:
- C. The FA bn critical fire support tasks (CFST):

| Tasks | Purpose |
|-------|---------|
| 1. | |
| 2. | |
| 3. | |
| 4. | |
| 5. | |

2. Battery Mission:

A. The battery critical tasks:

| TASK | PURPOSE | REMARKS |
|------|---------|---------|
| | | |
| | | |
| | | |
| | | |
| | | |
| | | |
| | | |

Table C-15. **Sample battery fill-in-the-blank order (continued)**

3. Execution:

4. Service Support:

A. Location of decon site

B. Location of BAS

| | | | | | | |
|-----------------|--|--|--|--|--|--|
| POSITION | | | | | | |
| RESUPPLY SCH | | | | | | |
| R3P | | | | | | |
| LRP | | | | | | |
| MAINT PRIORITY | | | | | | |
| CL IV REQ | | | | | | |

C. Ammo distribution plan: Class V endstate for battery/platoons

D. Maintenance priorities

E. Recovery priorities

F. Priority of CSS assets

G. Priority of Class IV

H. Priority of Class III

5. Command and Signal:

A. Signal

Frequency change over time _____

Battery frequency _____ platoon voice frequency _____ / _____

platoon digital frequencies _____ / _____

Battalion command frequency _____

Battalion fire support frequency _____

Battalion logistics frequency _____

Challenge and password _____

Recognition signals _____

Retrans frequency _____

B. Succession of command _____

C. Risk assessment:

1. Identified risk

2. Actions to minimize risk

APPENDIX D

COMMON MISTAKES AND MALPRACTICE

D-1. PROBLEM AREAS

Inaccuracies in cannon artillery fires cause wasted rounds and a decrease in the effectiveness of fire support. Many of these inaccuracies can be attributed to careless and/or improper procedures at the howitzer or aiming circle. The key to minimizing human error and careless gunnery procedures is proper training. The problem areas discussed below give the commander a starting point for evaluating the training level of his unit.

D-2. PRECUTTING CHARGES

Charges will be cut only after the command **CHARGE** is given or, if **CHARGE** is not announced, after a subsequent element of the fire commands (fuze, deflection, and quadrant) is announced. Often, when charges are precut, the increments are placed in a powder pit. This causes two problems, as follows:

- a. The increments are exposed to moisture, direct sunlight, and so forth. Thus, it is impractical and unsafe to use them again.
- b. If placed in a powder pit, the unused increments are normally burned before the unit leaves the position. If the fire missions involve the use of various numbered charge increments, there is a good chance that a wrong charge could be fired. If the propellant is not used and is missing one or more increments, it cannot be returned to the ASP because it is not a complete charge. A report of survey for accountability is required.

WARNING

Firing an incorrect charge is the single most common reason that a unit fires out of safety limits. This can result in fratricide. Do not place remaining powder increments for precut charges in the powder pit until the rounds for which the charges were cut are fired. For separate-loading ammunition, keep the remaining increments in the powder canister with the respective charge. For semifixed ammunition, dangle the remaining increments over the lip of each cartridge case and seat the projectile. However, do not break the cord until the round is handed to the number 1 man and the chief of section has verified the charge for each round.

D-3. LAYING ON THE WRONG AIMING POSTS

This mistake is especially possible at night. Howitzer sections can color-code their aiming posts to preclude this. This is an extremely important consideration if the unit is on a fire base.

D-4. IMPROPER EMPLACEMENT OF AIMING POINTS

a. Aiming points are emplaced at certain distances from the howitzer so that the proper sight picture may be established. This is especially important when one considers the matter of displacement. Displacement is the undesired movement of the sight caused by traversing the tube or by the shock of firing. That is to say, if the sight is not centered over the pivot point of the weapon or if the weapon shifts backward during firing, it will be oriented toward the aiming point from a different angle. Corrections for displacement must be made when using the two close-in aiming points (collimator and aiming posts).

(1) The primary aiming point is the collimator, which is normally emplaced 4 to 15 meters to the left or left front of the weapon. Displacement is corrected by matching the numbers in the pantel with the corresponding numbers in the collimator. If the collimator is not emplaced within the distance stated above, the three graduations visible in the collimator will not align properly; the picture will be out of focus. Therefore, it will be impossible to correct for displacement. If displacement is not corrected, the weapon will not be oriented in the direction of the target.

(2) The aiming posts are emplaced 100 meters (far post) and 50 meters (near post) from the pantel. If the far aiming post cannot be placed at 100 meters, the near aiming post should be placed half the distance to the far post (for example, far post, 90 meters; near post, 45 meters). This is very important for the following reasons:

(a) The distance to the aiming post is in direct relationship to the angular measurement taken when the displacement occurs. The farther the aiming post is from the sight, the smaller the angular measurement. The near post, because it is closer to the pantel, has the greatest angular measurement. This is the reason for the use of the near-far-line rule when correcting for displacement to the aiming posts. To correct for displacement to the aiming posts, the number of mils between the near post and the far post must equal the number of mils between the far post and the line (vertical line of the pantel).

(b) The rules of geometry and trigonometry tell us that if two points are on a line and the near point is half the distance of the far point from the origin, then the angle measured to the far point from a point that is not on the line is half the angle measured to the near point. That is to say, the angle measured to the near post will be twice that of the far post only if the near post is half the distance to the far post. Therefore, if the near post is not properly emplaced, displacement will not be properly accounted for, and the weapon will not be oriented correctly.

(3) To measure the distance from the piece to the aiming posts, the stadia method may be used. The pantel and the aiming posts are used as measuring devices.

(a) A cannoneer, in setting out the aiming posts, holds the upper section of one of the aiming posts in a horizontal position, perpendicular to the line of sighting. The gunner measures the length of the section in mils by using the reticle of the pantel. For example, the upper section of the aiming post is $4\frac{1}{2}$ feet long and measures 14 mils when it is 100 meters from the piece (Figure D-1). The proper location of the near aiming post, in this case, would be the point at which the $4\frac{1}{2}$ -foot section measures 28 mils (Figure D-2).

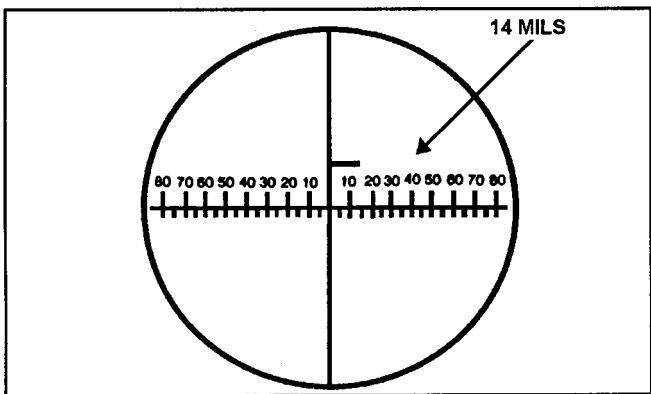

Figure D-1. Aiming post sight picture at 100 meters

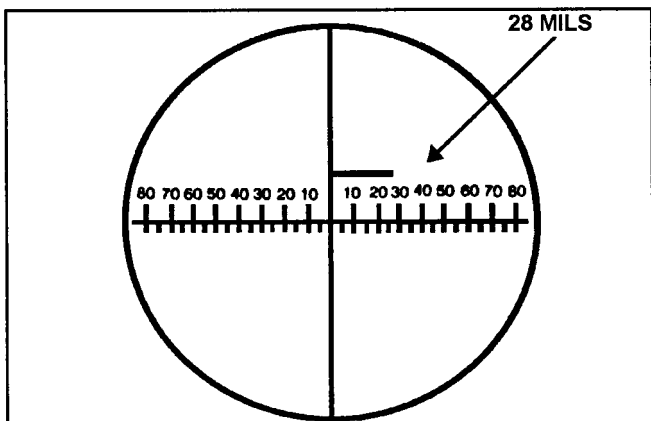

Figure D-2. Aiming post sight picture at 50 meters

(b) In many cases, the ideal spacing of 50 and 100 meters cannot be obtained. However, the aiming posts are properly separated when the near aiming post is set at a point where the $4\frac{1}{2}$ -foot section measures twice the number of mils it measured at the far aiming post location. This measurement maybe made at night by attaching the night lighting device at the $4\frac{1}{2}$ -foot marks on the aiming posts.

(4) Delay often occurs during emplacement of aiming posts when cannoneers move both the near and far aiming posts to achieve correct alignment. The procedure discussed below allows accurate placement of aiming posts in a minimum amount of time. Use of this method consistently results in posts requiring no more that 2 mils adjustment (often 0 mils), even when emplaced by entry level soldiers. This method, when used with aiming post lights, also greatly simplifies and speeds the night emplacement of aiming posts.

(a) Visually pick a point about 100 meters from the howitzer, and walk toward it in as straight a line as possible from the pantel. Place the near post in the ground 50 meters from the howitzer in as vertical a position as possible.

(b) Walk another 50 meters with the other post. Hold this post vertically in front of you. Looking toward the pantel, move the post left or right as directed by the gunner until the far post, near post, and the pantel of the howitzer are all on line.

(c) Ensuring the post is aligned with the gig line of your uniform, grasp the aiming post, raise your hands above your heat and stick the post vertically in the ground. The post should be vertical; adjust if necessary. Move to the near post and, with your right hand, adjust the post (if necessary) as indicated by the gunner.

(5) The DAP, though not emplaced, must be properly selected. When a single aiming point (other than the collimator) is used, it is not possible to correct for displacement. Therefore, the aiming point must be far enough from the pantel to ensure that there is no need to correct for displacement. The principle is very similar to that involving the aiming posts.

(a) The greater the distance between the sight and the aiming point, the smaller the angular measurement will be when displacement occurs. We do not normally fire deflections of less than 1 mil. Therefore, we must ensure that the angular measurement caused by displacement is less than 1 mil when we are using a DAP.

(b) We know that the greatest amount of displacement possible with any one weapon system is 1.5 meters. That being the case, we can determine the minimum distance for a DAP by using the mil relation formula.

EXAMPLE

X is the range to the DAP (in thousands); 1.5 is the maximum displacement possible (in meters).

$$\frac{1.5}{X} = \frac{1 \text{ mil}}{1}$$

$$\frac{1.5}{1} = \frac{X}{1}$$

X = 1.5 x 1,000 meters, or 1,500 meters.

The minimum distance for a DAP is 1,500 meters.

b. It is important that aiming points are positioned and/or selected to ensure that the howitzer can be oriented for direction throughout the various transfer limits. As a minimum, the aiming point should allow the section to cover the primary, left, and right sectors.

Note: There are eight sectors of fire in a 6,400-mil circle. These sectors are derived from the theory of transfer limits (see paragraph D-5c below).

D-5. FAILURE TO COMPUTE TERRAIN GUN POSITION CORRECTIONS

a. The digital link between the BCS and the GDUs will at some point fail to function. The problem may be in the BCS, one or more of the GDUs, or the wire line. When the failure occurs, voice fire commands must be transmitted to one or more of the howitzers. If the failure is at the BCS, voice commands must be transmitted to each of the howitzers. Therefore, it is important that TGPCs be computed. These corrections, as a minimum, should be computed for the primary, left, and right sectors.

b. TGPCs provide acceptable effects within the transfer limits for which they are produced. TGPCs can be produced either manually or with the BCS or LCU. Presently there are two methods of producing TGPCs with BCS or LCU (see the applicable job aids for step-by-step procedures).

(1) Calculate data for the center of the transfer limit for all howitzers in the firing element (during peacetime, range to center of impact area; in wartime, center range for the particular charge). From the data derived, calculate the difference in time, deflection, and quadrant of one of the howitzers and the rest of the firing element.

EXAMPLE

Number 1 is used as the base weapon.

| | 1 | 2 | 3 | 4 |
|------------|------|------|------|------|
| Time | 22.2 | 22.4 | 22.1 | 22.2 |
| Deflection | 3204 | 3201 | 3199 | 3196 |
| Quadrant | 405 | 421 | 396 | 408 |

TGPCs to be announced to the firing element are:

| | 1 | 2 | 3 | 4 |
|------------|---|------|------|----|
| Time | 0 | +0.2 | -0.1 | 0 |
| Deflection | 0 | R3 | R5 | R8 |
| Quadrant | 0 | +16 | -9 | +3 |

(2) Using a converged sheaf, calculate data to the center of transfer limit for all howitzers and for a ghost gun, whose location is center of battery. Calculate the difference between the ghost gun data and those of the firing element. The ghost gun at battery center uses the average platoon or battery muzzle velocity. This method is not as desirable as that in (1) above because all howitzers must carry a TGPC.

c. Transfer limits are defined as an area 400 mils left and right of center and 2,000 meters over and short of the center range. TGPCs derived for a given transfer limit are effective as long as all weapons are within 200 meters of battery center.

d. Enemy attack capabilities may be so great and concealment so poor that the firing element must be spread over an abnormally large area. This may require that TGPCs be produced for two or more groups within the firing element individually. For example, if the howitzers are positioned about 250 meters apart, it would not be feasible to compute only one set of TGPCs for a given transfer limit. A solution to the problem would be to compute TGPCs for sections 1 and 2 and then for sections 3 and 4, both computations deriving corrections from separate group centers. The FDC could then transmit the two sets of data rather than four sets. This would speed up the delivery of fires and ensure that there would be effects on target.

Note: This consideration is extremely important when live fire exercises are conducted during peacetime training. When surface danger areas are computed, piece displacement factors are included. In general, all weapons must be located within a 200-meter radius of a firing point marker or a surveyed grid location. Otherwise, an extended front must be requested. Consult local range regulations to determine restrictions of this type.

D-6. USING THE M139 OR M140 ALIGNMENT DEVICE TO VERIFY BORESIGHT

a. Boresighting is the process by which the optical axis of the weapons sights (the pantel and the elbow or direct fire telescope) are aligned parallel to the axis of the cannon tube. When this condition exists, the tube can be oriented parallel to the azimuth of fire upon occupation of a position. Thus, a target can be engaged with both indirect and direct fire.

b. When alignment devices were originally developed, it was intended that they be used to boresight. This was desirable because DAPs are not always available and transporting testing targets into a tactical environment is not practical. However, several problems have since surfaced which invalidate using an alignment device as a boresighting device:

- Cross hairs in the alignment devices shift.
- Locking lever wears and/or loosens.

c. Because of the above problems, the M139 or M140 should be used only to verify or check boresighting performed by other methods.

d. When performing fire control alignment tests, it is important that comparison tests be performed with the alignment devices to verify their accuracy.

D-7. OTHER MISTAKES

Other mistakes are as follows:

- Failure to correct the gunner's aid when the corrections were not needed.
- Transposition of numbers.
- Failure to center pitch and cross-level bubbles.
- Failure to compensate for backlash in the traversing handwheel by ensuring that the last movement of the handwheel is in the direction of the greatest resistance.

D-8. MALPRACTICE

Malpractice include blatant violations of standard procedures set forth in field manuals, technical manuals, and other publications. Some of these are as follows:

- Failure to have a second, safety qualified person, orient the verification circle and verify the lay of the howitzers.
- Having no system of double checks or leader checks on the actions taken.
- Exceeding the maximum and/or sustained rates of fire.
- Improper ramming, which may result in the projectile falling back on the propellant when the tube is elevated (separate-loading ammunition). If the projectile falls back on the propellant, expanding gases pass around the projectile (blow-by). This may decrease muzzle velocity. The projectile may be pushed forward towards the forcing cone. If so, the projectile will flutter and cause additional and unnecessary wear on the lands at the forcing cone.
- Improper testing of the gunner's quadrant.
- Improper or inconsistent placement of the propellant in the chamber.
- Incomplete and/or improper fire control alignment tests. These tests must be conducted in accordance with the technical manual to ensure that the fire control equipment is synchronized with the cannon tube.
- Cannon tubes improperly secured in travel lock. This causes damage to the traverse and elevation mechanisms.
- Leaving projectiles and/or propellants exposed to direct sunlight for extended periods. The result is erratic firing.
- Dropping projectiles or pallets of projectiles from the backs of ammunition trucks or carriers. Damage to the fuze well or rotating band may result.
- Failure to clean dirty projectiles before loading. The result is increased resistance in the bore, and a dragging effect on the projectile during flight.
- Lifting a round with a hand around the fuze.
- Failure to use a fuze wrench when tightening fuzes. This increases the chance of an in-bore explosion if gases escape around the projectile, or it may bring about a low-order burst upon reaching the target area.
- Removing the grommet protecting the rotating band before the round is placed in the bustle rack or on the loading tray.

- Improper procedures when transferring from primary to alternate aiming points during a tire mission.
- Attaching and/or picking up the lanyard before the proper command is given.
- Standing in the path of recoil when priming or performing misfire procedures.
- Failure to segregate propellant by lot.
- Failure to perform prefire checks in each position.
- Failure to cycle through the GDU on each command, verifying the number of rounds, charge, fuze, and projectile. Chiefs of section often look at only the deflection and quadrant.
- Failure to cross-level the collimator.
- Firing a round through an oily tube.
- Moving an SP howitzer when there is no intercom communications between the track commander (TC) and the driver of the howitzer.
- Improper shifting of trails on a towed howitzer. (Refer to -10 TM for that weapon system.)
- Failure to perform equipment PMCS on a routine basis, especially cleaning the tube of the howitzer.

D-9. ERRORS IN SETTING UP AND ORIENTING THE AIMING CIRCLE

a. Some typical errors are as follows:

- Failure to tighten the instrument-fixing screw securely. The head of the aiming circle will turn on the tripod, causing errors in readings given to the howitzers.
- Not clearing the area of magnetic attractions (especially weapons, steel helmets, and eyeglasses) when the magnetic needle is used.
- Failure to use a plumb bob and properly level the aiming circle, which could result in incorrect lay data.
- Failing to first roughly orient the 0 -3,200 line when measuring an azimuth or an orienting angle. This could lead to a 3,200-mil error.
- Inadvertently reading the red numbers rather than the black numbers on the azimuth scale.
- Failure to set up the tripod so that one leg is oriented in the approximate direction of sighting. This puts one tripod leg in the instrument operator's way as he moves around and increases the likelihood he will knock the aiming circle off level or over.
- Inadvertently moving the lower motion when movement of the upper motion is desired. When this occurs, the 0 - 3,200 line will be reoriented along a different azimuth.

- Making a 100-mil error in reading or setting deflections, instrument readings, and so forth on the upper motion. This is easy to do if one is not careful to read the numbers on the azimuth scale in a clockwise direction. When setting readings on the upper motion, it is best to set off 00 on the azimuth micrometer knob and then set off the first two digits of the reading on the azimuth scale.
- Using an improper base length to perform subtense for distance measuring; for example, using the M16 when distance is greater than values listed in the appropriate table.
- Failure to update piece location in the FDC with final lay deflections or when survey closes.
- Verifying lay before the primary aiming point is emplaced or boresight is verified.
- Leaving aiming circles attached to tripods during movement so they later become unserviceable.
- Failure to verify the azimuth to the EOL. To verify the azimuth to the EOL-
 - Set off the declination constant on the upper motion.
 - Float and center the magnetic needle with the lower motion.
 - Sight on the EOL with the upper motion, and check the reading on the scale with that given to the EOL.
 - Map-spot the grid coordinates.

b. The result of an error in determining azimuth can be computed as it is a function of the mil relation formula. An error has a direct effect on direction and the accuracy of the fired round. See Figure D-3 and the example below.

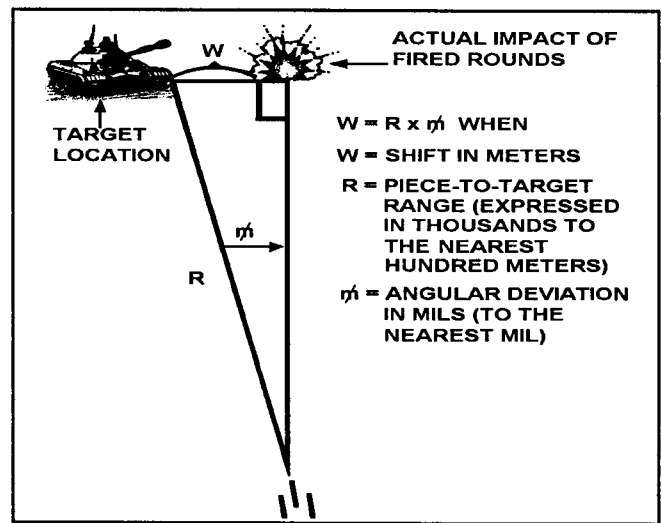

Figure D-3. Mil relation formula

EXAMPLE

Your unit initially laid on an azimuth of 5900 by using the grid azimuth method during a hasty occupation. The rounds fired by your unit are off the target. You determine, after obtaining accurate survey control for direction, that you are actually laid on an azimuth of 5880. At a range of 10,000 meters, any initial data would include a lateral error of 200 meters. This lateral error is determined by using the mil relation formula as shown in Figure C-3.



$$R = \frac{10,000}{1,000} = 10 \text{ (range to target)}$$

(10,000 is already expressed to the nearest 100.)

$$= 5900 - 5880 = 20$$

(Always subtract the smaller value from the larger value)

$$W = R \times$$

$$w = 10 \times 20 = 200 \text{ meters}$$

that cause equipment failure and injury or death to personnel. Some examples of incidents are discussed below.

a. During a live-fire exercise involving an M109A3 howitzer battery, unsafe charge data was transmitted from the BCS to the GDU. Both the FDC and the howitzer crew failed to catch the error. The round was fired out of safe, resulting in a fatal injury.

(1) The BCS operator and FDO failed to review the firing data before sending the commands to the firing battery.

(2) The howitzer crew failed to verify the firing commands against the safety T.

b. During a live-fire exercise involving an M109A3 howitzer battery, a howitzer misfired. The primer had fired, but there was no ignition of the propellant. The Number 1 crewman stated "It's just the primer; let me get it." As he stepped behind the breech, the cannon fired. The recoiling tube caught the Number 1 man in the chest and threw him to the rear of the cab. Also, fire from the breech recess engulfed the cab, burning several crewmen. The round fell short, just inside the buffer zone.

(1) The crew was not properly trained on misfire procedures.

(2) The Number 1 man had placed the charge in the powder chamber with the igniter forward, failing to announce **I SEE RED!** Therefore, the propellant was slow to burn until the igniter was lit. The M109-series weapons have breeches that open automatically when the tube is returned in battery. This resulted in tire escaping out of the breech recess.

D-10. INCIDENTS

Lack of attention to detail, improper supervision, and failure to make safety checks lead to mistakes and malpractices

APPENDIX E
LOAD PLANS FOR HOWITZER AMMUNITION

This appendix provides loading guidance for ammunition-carrying vehicles that are peculiar to a specific howitzer. A loading plan for a prime mover for a towed weapon is in Figure E-1. Standard camouflage configurations for the M109 howitzers are in Figures E-2 through E-6. General information on the plans follows.

- a. The load plans are based on the rated load-carrying capability of the vehicle. Allowance of 200 pounds per man was made for the crew that would occupy the vehicle.
- b. The plans illustrated in this appendix are for basic loads. However, because of mission and allocated amounts of ammunition, load plans may vary from unit to unit according to unit SOPs.
- c. The weight of the load must not exceed the rated capability of the vehicle.
- d. Ammunition capabilities and limitations for the M992 are in TM 9-2350-267-10, Chapter 2. Load plans and capabilities for the M992A2 are in TM 9-2 350-293-10, Chapter 2.

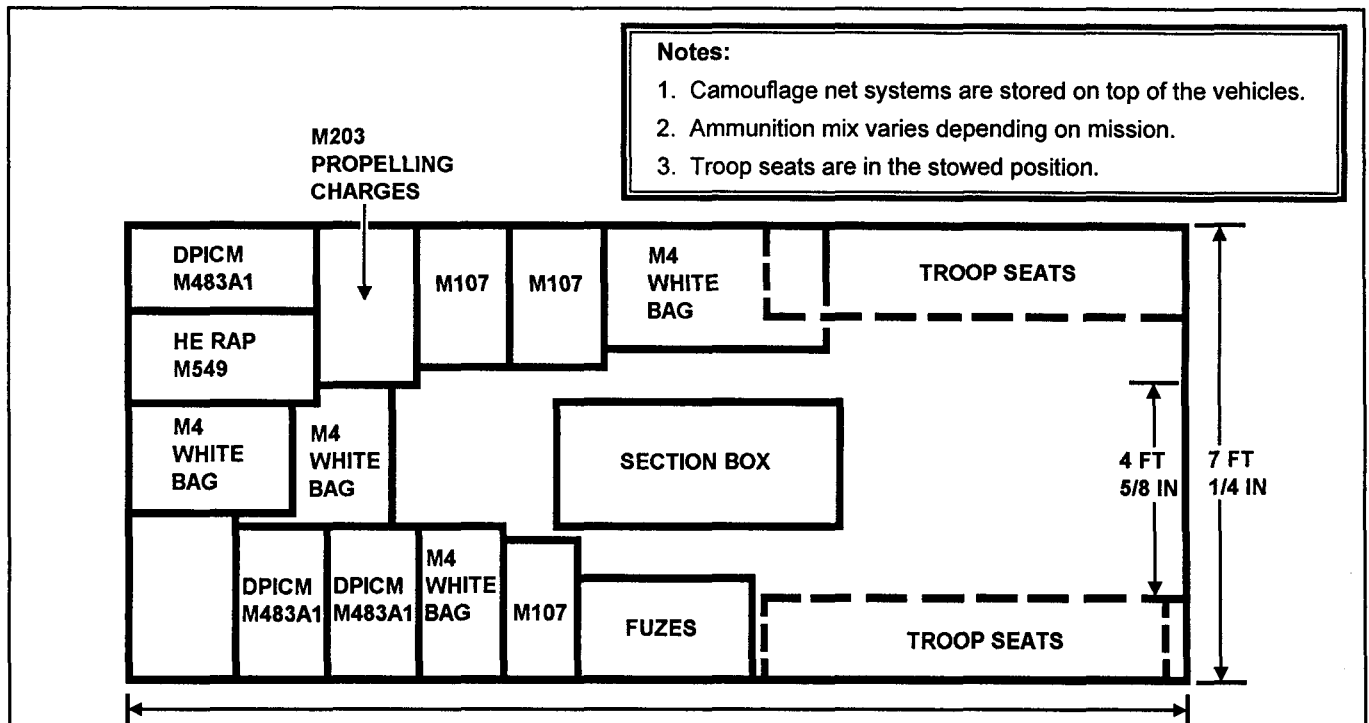

Figure E-1. Example 5-ton prime mover load plan for M198 section

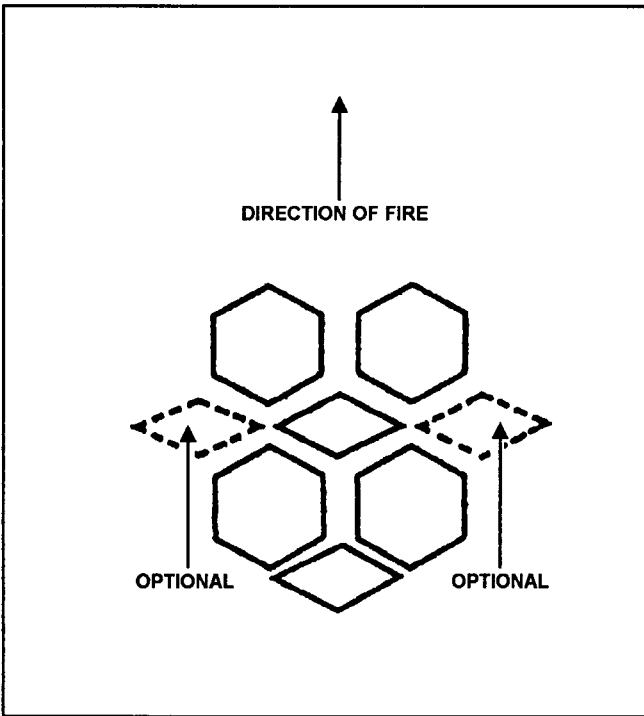

Figure E-2. Camouflage configuration for M102/M119A1

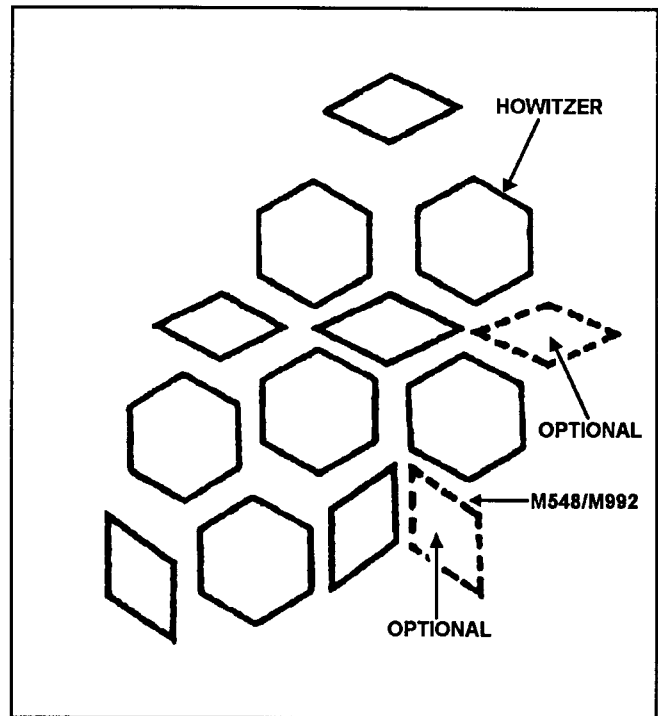

Figure E-4. Camouflage configuration for M109A2-A5 (L-shape)

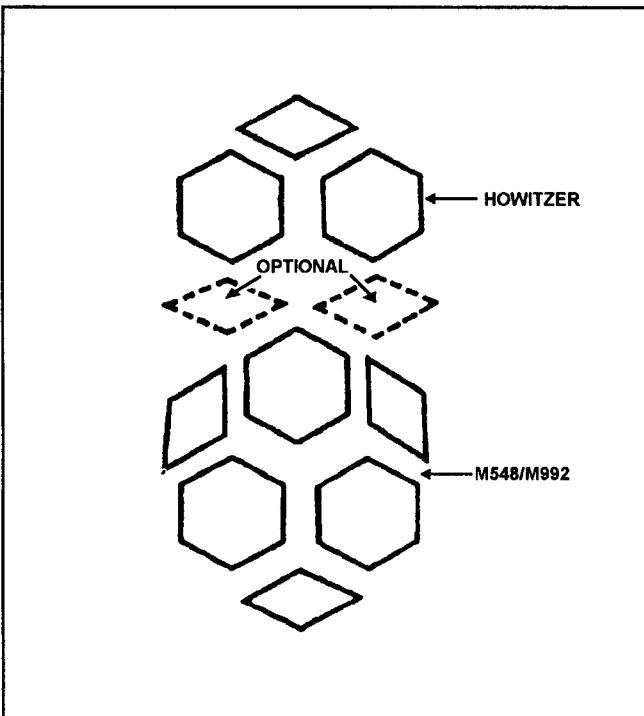

Figure E-3. Camouflage configuration for M109A2-A5

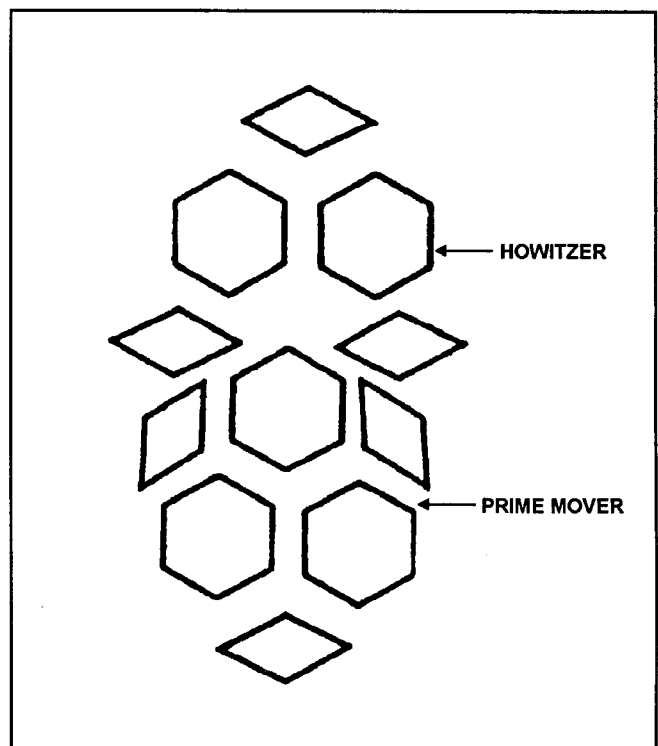

Figure E-5. Camouflage configuration for M198

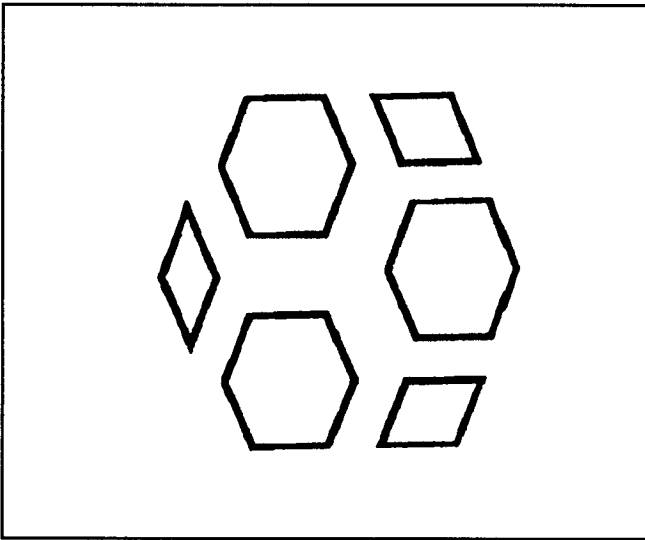

Figure E-6. Camouflage configuration for M101A1

APPENDIX F

SPECIAL OPERATIONS

F-1. OPERATIONS IN MOUNTAINOUS TERRAIN

a. Fire Support Tasks. More ammunition may be required to support the maneuver force in mountainous terrain because of reduced munitions effects. Cross-country restrictions force the enemy to use roads and trails, which will enhance interdiction fires.

b. Command and Control. The command and control of the battery are degraded because of decreased effectiveness of radio communications. Movement control is more difficult on winding mountain roads. Emplacement of wire lines is more difficult and time-consuming.

c. Positioning and Displacement. Because of the closeness of terrain masks, fewer suitable battery positions are available. High-angle fire may be required to accomplish the mission. Displacement is limited to the use of available roads, which generally are narrow and twisting. Terrain march may be impractical or impossible. Air assault operations are likely.

d. Other Considerations. Logistics resupply is more difficult because of the limited number of roads and the slower convoy speeds. Survey may not be as accurate and target acquisition may be limited by terrain masks. Emplacing on hills increases the range of howitzer weapons systems. Ambushes are likely in this type of terrain.

F-2. OPERATIONS IN JUNGLE TERRAIN

a. Fire Support Tasks. Jungle operations present problems because of the high humidity and dense vegetation. Humidity may degrade the ability of propellant to achieve desired ranges. Also, it may reduce equipment operability. Measures must be taken to ensure that powder is kept dry. Dense vegetation degrades munitions effects. In thick canopy, VT and ICM are ineffective. Fuze PD may be set on delay to penetrate to the ground and achieve the desired results. White phosphorus can be used to assist observers in adjusting fire in dense jungle.

b. Command and Control. Communications equipment is degraded because of high humidity, vegetation density, and electronic line-of-sight. Antennas may have to be elevated to overcome line-of-sight restrictions. Emplacement of wire lines is more time-consuming.

c. Positioning and Displacement. High angle fire may be required to overcome potential site-to-crest problems. Selection of firing positions is hampered by soft terrain and thick vegetation. The battery must be prepared to clear fields of fire. Fire base operations are viable means of providing for defense of the battery, as well as for 6,400 mil fire support. Mobility is slowed because the ground on available roads is soft and use of terrain march is restricted. Air assault operations are likely.

d. Other Considerations. Logistics resupply is hampered by reduced mobility. Survey control is more difficult to establish, and survey parties need more time to complete their tasks. Target acquisition accuracy is degraded because of heavy foliage. Whether fire-base operations are used or not, weapon systems should be positioned closer together to provide for better security of the battery position.

F-3. NORTHERN OPERATIONS

a. Fire Support Tasks. Northern operations are characterized by frozen earth, snow-covered terrain, intense sunlight, and prolonged darkness. Smoke lasts longer and travels farther in cold weather; however, snow usually smothers the smoke canisters. White phosphorus gives the desired results, but the particles will remain active in the area longer and restrict use of that terrain. Artillery fires may be used to start snow slides or avalanches as munitions effects multiplier.

b. Command and Control. Radio communications can be unreliable in extreme cold, and equipment may become inoperative. Emplacement of wire lines is more difficult and time-consuming over frozen or snow-covered terrain.

c. Positioning and Displacement. Frozen, snow-covered terrain may limit the number of available positions for battery emplacement. Mobility is slowed, as wheeled vehicles and trailers are generally not suited for operations in northern areas. In extreme cold, metal tends to become brittle and parts breakage increases. Convoys must travel in closed column during whiteout conditions and prolonged darkness. Air assault operations are likely.

d. Other Considerations. Logistics resupply is hampered by reduced mobility and difficulty in determining grid locations. Target acquisition equipment can be adversely affected by snowstorms and intense cold. Without the use of PADS, survey may be more time-consuming.

F-4. MILITARY OPERATIONS ON URBANIZED TERRAIN

a. Fire Support Tasks. The massive growth of urbanized areas and man-made changes to the landscape significantly affect the conduct of future battles. Avoidance of these areas during periods of conflict is no longer possible. Therefore, FA commanders at all levels must be aware of the unique advantages and disadvantages associated with operations conducted in and around cities, towns, villages, and similar built-up areas. The special artillery technique of direct fire may be used more frequently on urbanized terrain than elsewhere. Within the built-up area, high angle fires are most effective in attacking the defiladed areas between buildings.

b. Command and Control. Command and control of a tiring platoon operating in an urban area are demanding. Decentralization to the maximum feasible extent may be required. The reduced ability to communicate and extended platoon frontages necessitate more detailed orders and SOPs. Tactical communications in the firing platoon area are severely affected. The height and density of structures will reduce the planning ranges for all organic radio equipment. Wire takes on added importance. It is less vulnerable to disruption if run on existing telephone poles or through buildings and sewers. More use must be made of messengers and prearranged audio and visual signals. Imaginative positioning of antennas, such as intermingling them with existing civilian antennas or in treetops, may increase transmission range and enhance the survivability of the unit. Existing civilian communication networks should be actively sought out and used to supplement the organic capabilities of the unit.

c. Positioning and Displacement.

(1) When field artillery is used in an urban environment, selected position areas should—

- Be free of civilians.
- Be away from the center of the built-up area.
- Minimize masking.
- Have several routes of escape.
- Be off the main high-speed avenues.
- Afford as much cover and concealment as possible.

(2) The use of existing structures (such as barns, auto repair shops, and warehouses) as firing or hiding positions provides maximum protection and minimizes the camouflage effort.

(3) More time must be allotted for the reconnaissance of potential position areas. Depending on the density of

buildings in the area, the reconnaissance party may have to use infantry techniques for house-to-house fighting to clear and check the buildings.

(4) Special techniques for the emplacement of howitzers may be required if the ground is not suitable for normal emplacement. Consideration should be given to placing howitzer spades against curbs, rubble, or building walls. Also concrete or asphalt surfaces may also be softened for howitzer emplacement by use of shaped charges.

(5) Because of the expanded occupation required in the urban area, displacement by platoon may be impossible. In this case, displacement may be by howitzer section.

d. Other Considerations.

(1) Battery personnel must be prepared to use hasty survey techniques to establish directional and positional control. Magnetic instruments are impaired when operating in a built-up area, and their accuracy is degraded.

(2) Plotting of current friendly positions, perhaps down to platoon or squad level, maybe critical in reducing incidents of fratricide.

F-5. DESERT OPERATIONS

a. Fire Support Tasks. Deserts are arid, barren regions that cannot support any quantity of life because of lack of fresh water. They are characterized by temperature extremes (+136°F in Libya or Mexico to bitter cold in the Gobi Desert) with fluctuations exceeding 70°. Fire support considerations vary according to the type of desert; however, considerations common to all include munitions effects due to the temperature extremes and a lack of identifiable terrain features. The three types of deserts are discussed below.

(1) The **mountain** desert is characterized by barren, rocky ranges separated by flat basins that may be studded by deep gullies created during flash floods. Terrain will support all types of artillery, but is best suited for SP artillery.

(2) The **rocky plateau** desert has slight relief with extended flat areas, and good visibility. It is characterized by steep-walled eroded valleys (wadis). These are extremely attractive for artillery positions but are subject to flash flooding.

(3) The **sandy** or **dune** desert has extensive flat areas covered with dunes subject to wind erosion. The dune size, the texture of sand, and the leeward gradient may prohibit terrain movement entirely.

b. Command and Control. Map reading is difficult and resections are impossible unless a number of prominent points are available. Survey performed by PADS is most useful:

otherwise, a hasty astro or simultaneous observation is a must for an accurate direction.

c. Positioning and Displacement. Lack of vegetation makes camouflage difficult. In all cases, the artillery battery will be visible to the ground observer, as the netting silhouettes against the sky. From about 1,200 feet in the air the camouflaged installations appear bigger than the surrounding dunes or mounds of sand and vegetation. If engineer assets are available, digging in all the battery's vehicles below the surface of the desert and stretching the desert camouflage nets flat or nearly flat over the vehicles provides not only good concealment from ground observation but also excellent cover against direct fire weapons.

d. Other Considerations. High temperature and ever-present sand cause failures in mechanical and electronic equipment. Fuel and air filters must be cleaned after each operation, sometimes twice per day. Optics must be protected before the glass becomes opaque. Static electricity caused by the hot winds interferes with refueling operations and with radio traffic. Turning radius of tracked vehicles is limited because of the buildup of sand between the idler wheel and track.

CAUTION

Excess sand built up in this area will throw the track and/or shear off the idler wheel.

F-6. AMPHIBIOUS ASSAULT

a. Fire Support Tasks. Inherent in the concept of an amphibious assault is the projection of a fighting force into an area on shore that is assumed to be heavily defended. The force must be built up in combat power from zero strength to a point where it is effective and credible. To support the maneuver element, a battery must be prepared to lay and fire immediately upon landing. For further information concerning amphibious operations, refer to NWP 22-2/FMFM 1-7.

b. Command and Control. Initially, command and control are highly centralized. Battery position areas, displacements, and fire control are centralized at the battalion level. Communication between the two platoon main bodies and battalion operations is critical in effecting movement with the least disruption of fires.

c. Positioning and Displacement. Because of the small size of the beachhead, positioning coordination with the supported maneuver forces is of extreme importance. Units must remain flexible to change the predetermined positions on the basis of events within the beachhead. Get off the beach as soon as possible.

d. Other Considerations. Units must plan to embark and debark with all available MTOE equipment. Vehicles must be prepared for fording. Vehicle tires may be partially deflated for improved performance on beach sand. Survey generally is not present during the first stages of the landing. Survey must be established forward as early as possible. Salt water and sand increase the need for preventive and corrective maintenance. Unit basic loads must be transported forward with the unit. An adequate ship-to-shore resupply of ammunition must be coordinated by the maneuver unit S4.

F-7. AIR ASSAULT OPERATIONS

a. Movement. Entire firing batteries are moved to quickly project FA fire support into a battle area, to attack special targets, to bypass enemy concentrations or untrafficable terrain, and to facilitate future operations. Sustained operations may be conducted from the new battery position. Detailed planning and coordination, aggressive execution, and speed of emplacement are essential to mission success.

b. Capability. Because of the diversity of the aviation mission and demand for aviation assets in a tactical environment, it is imperative that proper aircraft be used to perform various air assault missions. Aircraft available for external load operations are the UH-1H Huey, UH-60 Blackhawk, and CH-47 Chinook (A-D models).

c. Mission Planning.

(1) Many factors influence the commander's planning for an air assault mission. The commander must plan more extensively than for a conventional operation. In planning he considers the following:

- **M:** Mission.
- **E:** Enemy.
- **T:** Terrain and Weather.
- **T:** Troops available.
- **A:** Aircraft available.
- **L:** Load requirements (equipment which will be taken). Ensure cross-loading of critical equipment and identification of the aircraft and personnel bump plans. These actions are critical to ensure minimum mission-essential equipment arrives on the LZ.

(2) Firing elements are moved by air in four phases:

- Planning and preparation.
- Rigging and loading.
- Movement.
- Occupation of position.

(3) Thorough and timely planning for an air assault operation is critical to the success of the mission.

(4) The commander plans the operation by using the reverse planning sequence. The sequence of planning for an air assault operation are as follows:

- Ground tactical plan.
- Landing.
- Air movement.
- Loading.
- Staging.

(5) Coordination is made through the S3 AIR, with final coordination being made at the air mission brief (AMB).

d. Air Mission Brief. The AMB is a coordinating meeting attended by the ground commander and a representative of the aviation element(s) that will provide the aviation support for the mission.

(1) The AMB sequence established below applies to ideal situations, when adequate time is available. At times, the situation or the mission may preclude a formal meeting. Then the AMB will consist of an exchange of information between the ground commander and the lift commanders on the pickup zone (PZ).

(2) The recommended sequence for the brief is as follows:

- Brief the mission.
- Brief the threat and the weather/light data.
- Brief the execution as follows:
 - Primary and alternate PZ and landing zone (LZ) locations, times, configurations, markings, and pathfinder support.
 - Planned fires (preparation, suppression of enemy air defenses [SEAD], and/or extraction) and available supporting fires.
 - Troop and equipment loads.
 - Air cavalry, attack helicopter, tactical air employment.
 - Abort criteria.
 - Code words.
- Coordinate for the following.
 - Aircraft linkup points.
 - Air control points.

- Hand-off points.
- Downed aviator pickup points.
- Gun target line.
- Primary and alternate routes and penetration points, to include deception measures.
- Aircraft formations, altitude, and speed.
- Aircraft crank time.
- Aircraft ordnance.
- Exchange of call signs, frequencies, SOI edition in effect, IFF information, key list information, and challenge and password.
- Synchronization of watches.

e. Mission Execution.

(1) Pickup zone selection. The PZ should be at least 500 meters from the battery position, because the battery position may have been targeted by enemy target acquisition assets. At a minimum, the PZ should meet the following requirements:

- Free of obstructions that would hinder flight operation.
- Trafficable terrain.
- Adequate concealment is available for equipment and personnel while awaiting aircraft arrival.

Note: A terrain sketch should be made of the PZ, if possible, and used to brief the XO/platoon leader and the PZ team before they occupy the PZ.

(2) Landing zone reconnaissance and selection. A daylight visual reconnaissance of the intended LZ area is made whenever possible, with the flight being oblique to the area rather than directly over the area. If this is not possible, the commander will make a map recon and use all available electronic and photo surveillance assets. If it is necessary to use pathfinders, coordination must be made through the S3. As a minimum the following must be done:

- Determine if the LZ is large enough.
- Determine if firing positions that will support the mission are available nearby.
- Note the enemy routes of advance into the LZ area and any enemy activity.
- Note location of friendly forces.
- Select alternate LZs.

(3) Pickup zone occupation.

(a) The commander takes an advance party to the PZ. Its mission is to conduct a security sweep and to familiarize the ground guides with the proposed layout of the equipment on the ground.

(b) The battery displaces from the position and occupies the PZ. The minimum time necessary is allowed to rig equipment before the aircraft arrive.

(4) Pickup zone organization.

(a) Equipment should be placed so that after the first loads are lifted following loads are lifted sequentially (either left to right or front to rear along the line of flight).

(b) Sections must provide security of the PZ while their equipment is being rigged. The PZ security must be coordinated and areas of responsibility designated.

(5) Personnel responsibilities in the pickup zone.

(a) The battery XO or platoon leader is the officer in charge of the pickup zone.

(b) Normally, the advance party for the LZ is the same party that sets up the PZ.

(c) The PZ party consists of the hookup team. The composition of the party depends on the number of aircraft available for the lift. To more easily move the party to the LZ, the last lift should be an internal load.

(d) All remaining section members make up the rigging party and main element. They rig their equipment and provide security as required.

(6) Landing zone organization. The LZ must be secured upon arrival of the advance party. The battery commander selects landing positions on the basis of his reconnaissance and lift sequence. If simultaneous loads are to be delivered to the LZ, the LZ is to be occupied as a firing position, and the LZ size will not accommodate all aircraft, the commander may have to stagger the lift sequence on the PZ so adjacent howitzers are not delivered to the LZ at the same time.

(7) Landing zone execution. Signalmen identify themselves and their landing point by holding a road-guard vest or an orange panel. When the aircraft identifies the signalmen, the guide directs the load to the landing point and direct unhooking of the load and landing of the aircraft. After the aircraft departs, the crew de-rigs the load and moves the equipment to the point specified in the ground tactical plan. When all equipment has been delivered, the unit reestablishes contact with and support of the maneuver force.

F-8. ARTILLERY RAIDS

The artillery raid is the rapid movement of artillery assets by air or ground into a position to attack a high-priority target with artillery fires. It could involve operations across the forward edge of the battle area (FEBA). Normally, the raid is extremely short and should not involve sustained operations. Detailed planning, surprise, and speed in execution are the key factors in the successful conduct of a raid.

a. Planning and preparation. Most standard air assault procedures apply in the conduct of an artillery raid, with some additional considerations. Because the target is likely to be perishable, the planning phase must be very short. Effective SOPs are essential. Pilots must understand load composition and configuration. Some planning considerations are as follows:

(1) Only bare necessities should be taken.

(2) Ammunition for an M102/M119 raid may be hand carried on the aircraft (combat only). Ammunition for an M198 raid may be strapped to the firing platform (combat only) or suspended from the howitzer in an A-22 bag.

(3) A mixture of HE, W/P, and ICM provides excellent munitions effects for a raid.

(4) An M198 raid may include FASCAM and DPICM.

(5) Firing data can be precomputed and given to the XO before he leaves the PZ. He may want to distribute the data to the section chiefs on the PZ. If PADS is available for the mission and digital communications can be established between the LZ and the battery FDC, firing data can be computed after accurate weapon location information is sent to the FDC.

(6) When determining LZ location, the highest charge possible should be planned to increase standoff range. However, if charge 7 is used (M102), mission time is increased because all eight stakes must be driven in the firing platform.

(7) Security elements to accompany the raid should be requested from the infantry.

(8) Attack helicopters should fly cover and provide SEAD, especially if the raid is out of range for friendly artillery fires.

(9) The number of howitzers taken forward on the raid is determined by target analysis, munitions effects tables, aircraft availability, and desired damage criteria.

(10) In preparation for an M102/M119 raid in which the howitzers are carried internally during insertion and extracted externally by sling load, the loads should be partially rigged in the PZ before the mission begins.

(11) Emplace false insertions along the flight path. False insertions are only effective if howitzers are being carried internally.

b. Air Mission Brief. The AMB for the artillery raid contains the same elements as for a battery air assault mission, with the following additions:

(1) Because artillery raids involve the extraction of all personnel and equipment, a laager site must be designated for the aircraft during the firing of the mission. The aviation representative designates the site. The artillery commander ensures that it provides for the rapid extraction at the end of the mission.

(2) Code words and/or signals must be arranged for the recall of aircraft at the end of the mission.

c. Pickup Zone Operations. The PZ operations are generally the same as with the air assault mission.

d. Landing Zone Operations.

(1) The executive officer controls the LZ. The advance party guides orient aircraft on the landing points as with the air assault mission.

(2) When the aircraft have delivered their loads to the LZ, they move to the laager area.

(3) When the fire mission is complete, the howitzer crews prepare the weapons for sling load extraction. Designated members of the advance party assume the duties as hookup team(s). Security for the area is most difficult at this time, and howitzer section members must be designated to provide security.

(4) The XO recalls the lift helicopters by a code word on the FM net. Upon arrival of the aircraft, normal PZ procedures are followed.

(5) Following departure of the sling loads, the executive officer recalls the advance party aircraft.

Note: If there is to be live firing during training for an artillery raid, safety requirements must be established and strictly adhered to preclude any incident.

F-9. OPERATIONS OTHER THAN WAR (OOTW)

a. Artillery batteries maybe deployed to support operations other than war (OOTW). OOTW include missions that are

not considered conventional such as; noncombatant evacuation operations (NEO), security assistance, counterterrorism, counterinsurgency, peacekeeping, and peace enforcement. Because of the unconventional nature of these missions, units must consider additional factors when executing these difficult missions. Table F-1 gives a comparison of the battlefield factors involved in both conventional (wartime) operations and OOTW.

b. In OOTW, the battlefield is normally nonlinear, with maneuver elements conducting patrols, local air assaults, and protecting convoys. Therefore, the artillery cannot always follow the maneuver units. The placement of the artillery must be considered in planning for fire support. OOTW may require the firing units to remain in position for longer periods of time. Due to the length of their stay, units will have to harden the position to increase their survivability. The defense of a static firing unit requires different planning considerations than when the unit constantly moves. Since the unit is stationary, it is almost certainly going to be detected. This is the most fundamental difference between the two survivability techniques of moving and hardening. The threat on nonlinear battlefields is not one of armor or aircraft attacks or even heavy artillery fire. Rather, the threat in most OOTW situations is dismounted attacks and mortars. It is not necessarily less than in the conventional conflict, it is simply different.

c. In OOTW, it is critical that all personnel fully understand the mission (military and political), people, and rules of engagement (ROE). Artillery units may occupy positions with their supported maneuver element in a fire base (see paragraph F-10), or in an operating base (possibly shorter term and more mobile than a fire base). The unit must maintain a strong defensive perimeter with clear kill zones, interlocking fields of fire, and maximum grazing fires.

d. Standing operating procedures (SOPs) must be developed, rehearsed, and coordinated to effectively deal with typical OOTW situations, such as:

- Sniper fire.
- Mortars.
- The media.
- Displaced civilians.
- Handling of refugees.
- Use of weapons (lock and load instructions).
- Interaction with local military forces, check points, local police.

In addition, guidelines must be established on how to carry weapons (sling arms, port arms, muzzle up or down).

e. Field sanitation requirements must be well planned, because a unit may be in the same position for extended periods. Failure to plan for proper field sanitation, such as waste disposal, may result in nonbattle casualties.

f. Depending on the commander's assessment of the factors of METT-T, the following attachments may increase the success of the unit in OOTW:

- Air defense artillery (SHORAD).
- Radar (countermortar).
- Survey.
- Meteorological section.
- Civil affairs teams.
- Psychological operations (PSYOPS) teams.
- Infantry, armor, or MPs (to aid in security).
- Ground surveillance radar.

Table F-1. Comparison of conventional and OOTW battlefield factors

| Factors | Conventional | OOTW |
|-------------------------|---------------------------------------|--|
| Enemy threat (in order) | Artillery, armor, air, dismounted | Dismounted, indirect fire, terrorist attacks |
| Enemy missions | Defend, attack, maneuver | Causes US casualties, involves civilians |
| Friendly missions | Defend, attack, maneuver | Search and attack, protect convoys, defend |
| Terrain considerations | Linear, multiple positions | Restrictive, limited positions, 6,400-mil firing |
| FA survival techniques | Movement, dispersion, avoid detection | Hardening, defense |

g. If the firing unit is not deployed as part of a battalion, it must consider how classes of supply will be handled and if a logistics representative should be attached. Hardening a position will require large quantities of fortification and barrier material. This will almost certainly cause the shipment of class IV items to become a priority. If the supported maneuver unit is not capable of correcting maintenance problems and vehicle recovery, a maintenance representative or contact team should be attached.

F-10. FIRE BASE/HARDENED ARTILLERY POSITION OPERATIONS

a. When the primary threat is light infantry, guerrilla, or commando units without heavy weapons, FA units may expect to support the maneuver forces from fire bases. Units may occupy fire bases during conventional war, but this defense technique is most often used in operations other than war (OOTW). Hardened or fortified positions are similar to fire bases, but they lack the combined arms support from maneuver units found in fire bases. The planning considerations for fire bases and hardened or fortified positions, are the same. A fire base is a deliberate defensive position, similar in many ways to a maneuver strong point. In situations such as OOTW, it is not difficult for the enemy to determine the location of firing units; therefore, concealment is not a primary concern with respect to survivability. Hardening and a carefully planned and coordinated defense against ground attack are the essential elements for the battery to survive and continue to provide support during operations from a fire base.

b. Positioning of the firebase will be dictated by the mission and terrain. The primary consideration is that the fire base must be positioned so that it can support the maneuver unit. Individual battery fire bases are positioned so that they are mutually supporting. The position should allow 6,400 mil firing capability. The range fans (actually range circles) of the individual fire bases should overlap, both to allow massing of fires and to facilitate mutual defense.

c. Individual fire bases should be positioned on open, defensible terrain, with clear fields of direct fire in all directions. The area beyond the perimeter must be clear of foliage or structures that block vision for at least 580 meters (maximum effective range of the M16A2). Larger cleared areas are better yet. A hilltop makes an ideal fire-base location, as it provides clear kill zones and maximum grazing fires. The area outside the perimeter must be carefully surveyed by the defensive planner (normally the 1SG or USMC Local Security Chief); and covered avenues of approach must be identified for coverage by means other than direct fire (grenade launchers, claymore mines, artillery, and so forth).

d. The battery perimeter must be tightened and improved as much as possible. Concertina and barbed wire, mines, trip flares, remote sensors, and OPs or LPs are used to prevent entry into the battery position. As time and resources permit, the defenses are expanded and improved. Multiple bands of wire are established around the perimeter. Fighting positions are prepared at each howitzer position, the FDC, and the CP. This is to provide 6,400-mil defense of each individual element as well as to defend the battery position as a whole. If possible, fire bases should be collocated

with maneuver elements; and their defenses should be integrated into the overall maneuver defense plan.

e. Gun positions, the POC and/or FDC, and the battery CP must be hardened as much as possible. Gun pits and fighting positions are prepared and constantly improved. All personnel and ammunition are provided with at least 18 inches of overhead cover to protect them from incoming indirect fire. Preparing gun pits, clearing fields of fire, and establishing wire and other obstacles may well be beyond the capabilities of the battery. If so, engineer support must be requested; and the FSCOORD must coordinate with the maneuver brigade commander for priority of engineer support. A priority of work must be established for the engineer assets. (For example, first dig in FDC, then howitzers, then fighting positions, then field expedient devices to assist in filling sandbags.) Field Artillery units will, in any case begin hardening the position with whatever means available **immediately** after establishing firing capability and continue until ordered to move. As a minimum, the battery must carry basic Class IV materials (sandbags, concertina, pickets, 4 x 4s, plywood) and use these and other readily available materials (powder canisters, ammunition boxes, and so forth) to secure and harden itself. Internal wire lines should be buried to a depth of at least 12 inches, and redundant lines should be laid. Units may also consider the use of chain link fences around gun positions to protect from rocket propelled grenades (RPGs) and bomblet type submunitions.

f. The defense of the battery must be carefully planned and coordinated. Howitzers and crew-served weapons are positioned to provide interlocking fires. The star formation (Figure 2-4) is ideal for the defense of a battery-based unit, while the diamond formation (Figure 2-3) optimizes platoon defense. Figure F-1 shows a completed hardened position using a variation of the star formation. This formation could also be organized into a triangular formation. Detailed defense diagrams are prepared by each section chief, and the defense plan is integrated by the BC, battery first sergeant and/or the platoon sergeant. The perimeter must be continuously manned to the extent possible consistent with the basic mission to provide fire support. A plan for the all-out defense of the position must be developed and exercised, so that every individual soldier in the position knows his function and sector of responsibility. A reaction force must be designated and exercised under the control of the first sergeant. The composition of the reaction force, to include equipment (weapons and ammunition), should be specified in the unit SOPs. The scarcity of personnel in the firing battery and/or the nature of the threat may make it impossible for the battery to adequately man its own perimeter. Then the FSCOORD must request augmentation from the maneuver commander. Such augmentation should

include a battalion mortar platoon inside the battery perimeter; this increases survivability and makes resupply of mortars easier. Also, the addition of ground surveillance radar enhances detection outside the perimeter. While the maneuver commander will naturally be reluctant to divert any of his assets from their primary mission, the temporary loss of these assets is generally preferable to the permanent loss of a substantial portion of the brigade fire support.

g. Unit SOPs and plans for the defense must be detailed enough to ensure that all battery personnel know their individual responsibilities once an enemy attack commences. If maneuver, CSS, or allied personnel are habitually present in the fire base, they must be incorporated into the battery defense plan. Personnel temporarily in the compound must be briefed on what their actions should be in case of an attack. A standard set of visual symbols to tell fire base personnel when to execute various parts of the defense plan must be developed and disseminated to all personnel in the perimeter. The plan must be rehearsed, critiqued, and improved on a continuing basis.

h. If the field artillery unit is proficient in the conduct of patrols or if infantry is available, patrols should be conducted outside the perimeter. Their purpose is to prevent the enemy from staging in areas just beyond the line of sight of the fire base. As a rule of thumb, patrols should push out to the maximum range of the enemy's heaviest weapon, generally a light mortar. Should the patrol encounter enemy forces, it will very likely require fire support to disengage and to break up the enemy element. Fires must be planned in advance and the fire plan rehearsed, with dry fire if possible, before the patrol goes out. Once patrols are outside the wire, they must remain in constant communications with the CP; and their progress must be carefully tracked. In jungle or heavy forest, contact between the patrol and the enemy may well be made at ranges of less than 100 meters. The FDC must know the location of the patrol very precisely if it is to provide effective fires without endangering the patrol. Refer to FM 7-8 for specific instructions on the conduct of patrols.

i. The defenses must be constantly checked for evidence of tampering. The patrols will examine the perimeter from the outside, looking for cut wire, disabled sensors, or mines that have been deactivated or turned around (in the case of Claymores). Any evidence of tampering should be regarded as a warning of likely enemy attack, and alert states should be increased.

j. Unit SOPs must contain provisions for battery self-defense. These include gunnery techniques such as Killer Junior, firing flechette (APERS-T) rounds, or firing APICM into the wire.

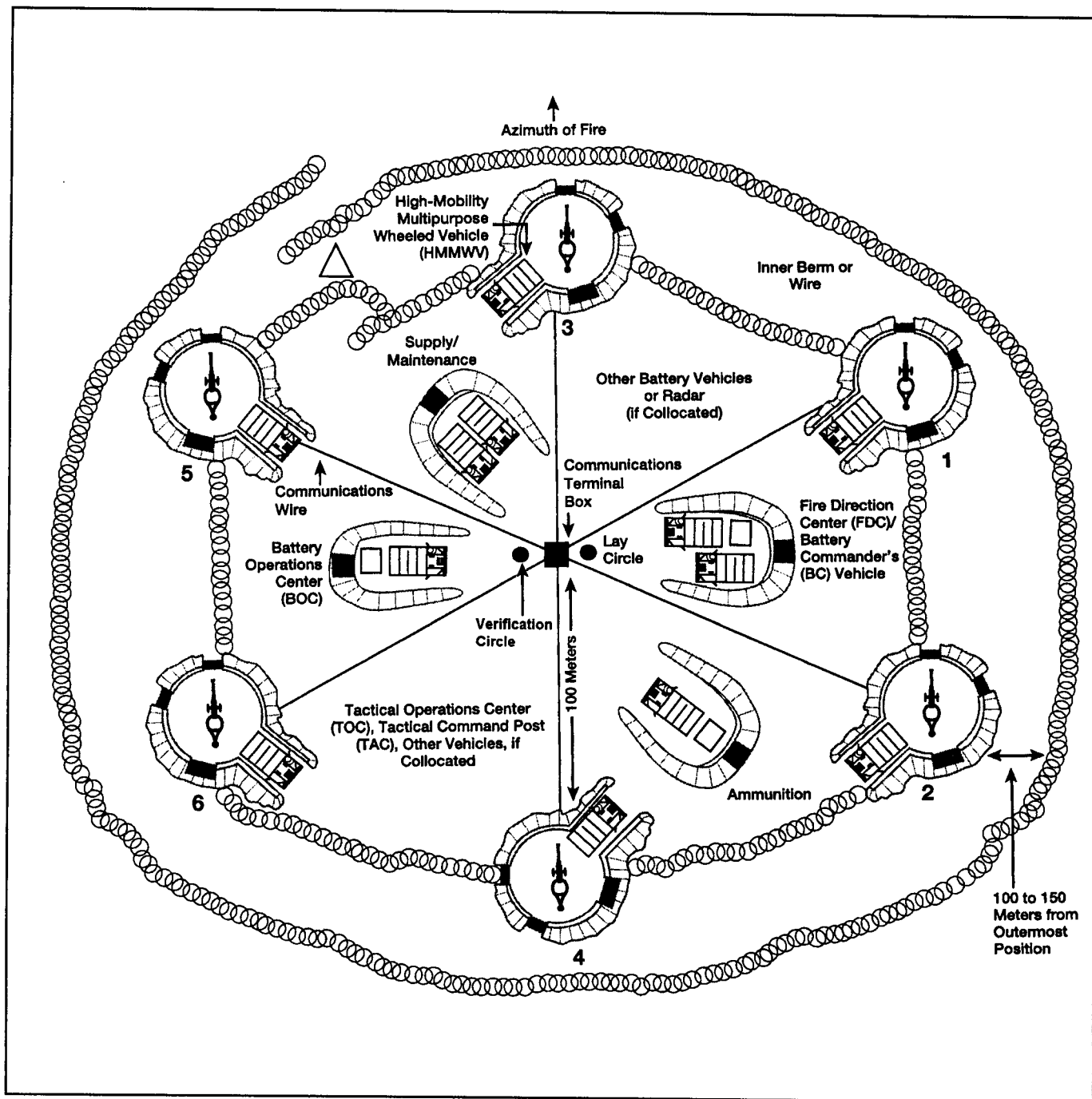

Figure F-1. Hardened battery position in star formation

(1) Killer Junior is a procedure that uses HE projectiles with mechanical time fuzes set to burst about 10 meters above the ground at ranges of 200 to 1,000 meters. Killer Junior techniques can be used with any of the current cannon systems. Specific techniques are described in detail in Appendix I of this manual. Battery personnel should note that when Killer Junior is used over friendly troops, soldiers

and equipment must be below ground with substantial overhead cover. Fighting positions over which Killer Junior is likely to be fired must be specially reinforced on the back side to protect the soldiers and to prevent collapse.

(2) APERS-T rounds are intended primarily for antipersonnel use at close range. The round comes fuzed

and set for muzzle action; however, it can be set for up to 100 seconds. The round is loaded with 8,000 8-grain steel flechettes. The APERS-T round is devastatingly effective against exposed infantry. There are two important cautions when using the M546 (APERS-T). First, the round may not be used over the heads of exposed friendly troops, even in combat emergencies. Second, the aluminum casing of the round is thin and easily damaged. Damaged rounds are unpredictable and should not be fired. The APERS-T round is available in only 105-mm caliber.

(3) ICM in the wire is a 105-mm and 155-mm technique. For 105-mm systems, it requires firing shell M444 (ICM) fuzed with the M565 MT fuze at charge 1. With a minimum time setting of 2 seconds and a QE of 1,250 mils, the round can be brought in as close as 300 meters from the howitzer. By decreasing QE and/or increasing the time setting, the range can be extended to 2,000 meters. Detailed instructions for this technique are in the approved firing tables. The 155-mm technique involves firing shell M449 (ICM) fuzed with the M565 MT fuze at charge 2 green bag (M3A1). With a minimum fuze setting of 2 seconds and a QE of 1,193 mils, rounds can be brought in as close as 400 meters. Detailed instructions for 155-mm systems are also in the appropriate firing tables. It is emphasized that this 155-mm procedure is for charge 2 green bag only. Firing charge 1 green bag at high angle from a M109A3/A6 or M198 is extremely hazardous, as the round may not clear the tube (sticker).

k. Resupply of the tire base will most likely be by air. If so, a suitable LZ or drop zone (DZ) within or near the perimeter is a major positioning consideration. If the battery is to be resupplied by ground transport, the fire base must be positioned near a suitable road.

l. If the unit is to be resupplied by ground transport, the entrance to the position can become a critical weak point in the tire base defense. A series of barriers must be established to slow the approach of vehicles to the entrance. This keeps the vehicles from crashing the gate at high speed and entering the compound. Gate guards must have the means immediately at hand to destroy any vehicle that tries to force entry into the perimeter.

m. For the final defense of the position, an internal perimeter is established around each gun position, each support section, and around the FDC and BOC. If the outer perimeter is penetrated, sections should stay in place and defend the battery/platoon from these positions. Once the situation stabilizes, the battery leadership executes a counterattack to reestablish the perimeter followed by a security sweep of each defensive position inside the perimeter.

n. Priorities of work must be established to efficiently occupy and defend a firebase or hardened position. The following is a typical priority of work:

(1) Advance party:

(a) Selection of a site that will support maneuver forces and is defensible, with open fields of fire, preferably out to 300+ meters.

(b) Scratch out positions for: howitzer and equipment berms, bunkers, vehicle positions, critical equipment positions, machine-gun sectors of fire, howitzer direct fire sectors, and so on.

(c) Construct individual hasty fighting positions 18-36" deep to lie in for protection from ground-burst indirect fire and small-arms fire, if attacked).

(d) Lay out initial defensive perimeter.

(2) During occupation:

(a) Site/emplace crew-served weapon systems.

(b) All personnel dig individual hasty fighting positions.

(c) Determine final locations for defensive fighting positions and howitzer sectors of fire.

(d) Finalize perimeter.

(3) After occupation:

(a) Emplacement of perimeter wire obstacle, mines, and early warning devices.

(b) Improving individual positions from hasty positions to one-or two-man fighting positions.

(c) Hardening/digging-in critical material and equipment (in priority).

- First, 1.18 inches of overhead cover for all personnel.

- Second, FDC/BOC.

- Third, howitzers.

- Fourth, ammunition.

- Fifth, remaining support vehicles and equipment.

(d) Identify and plan defensive targets.

(e) Improve perimeter wire.

(f) Tie-in internal defenses (assign direct fire sectors).

(g) Verify siting of defensive weapons/preparation and inspection of range cards.

(h) Coordinate with adjacent units for areas of responsibility, mutual support communications, patrol schedules, defensive targets, sectors of fire, call signs and frequencies, and any other matters required to integrate the two units' defensive plans. This will reduce fratricide.

(i) Rehearse battle drills for enemy inside the perimeter, snipers, air attack, mounted/mechanized attack, and so on.

(j) Maximize the use of night vision equipment.

Leaders must ensure everyone understands the priorities of work, and that resources are allocated to complete high-priority tasks first.

F-11. EMERGENCY OCCUPATION PROCEDURES WITH BCS

a. The BC reconnoiters the route to the new position, selects emergency occupation positions, determines map-spot locations, and transmits these locations to the platoon leaders.

b. The BCS operator enters these locations in BCS; PIECES format in order of possible occupation when platoon displaces. (As the platoon passes a predetermined position, that position can be deleted.)

c. When the platoon march-orders, the BCS operator erases the X in READY and places an entry in the OUTTIL field. He then transmits the AFU;UPDATE format to battalion tactical fire direction computer (IFSAS). This should allow the battery to complete its displacement without receiving a call for fire. Regardless, the BCS operator should be prepared to receive a fire mission. He does this by entering 3200 in the AZ field of the AFU;UPDATE. The BCS operator executes the AFU;UPDATE.

d. Upon notification of an emergency occupation, the BCS operator does the following:

(1) He displays the emergency occupation mission (FM;CFF). Then, after ensuring that the gun number

corresponding to the emergency occupation position is specified in the adjustment field, he executes the format.



(2) From the resulting set of firing data, he determines the new azimuth of fire by using the BACKWARD AZIMUTH RULE (paragraph 4-25).

(3) He enters the new azimuth of fire in the AZ field of the AFU;UPDATE format and re-executes the format.

EXAMPLE

Step 1. Place possible emergency occupation positions in BCS;PIECES format and 3200 in AZ field of AFU;UPDATE format.

Step 2. Upon receipt of fire mission request (FM; CFF), select pieces to fire (PTF) corresponding to appropriate position in BCS;PIECES and execute.

Step 3. Review firing data.

Step 4. Use BACKWARD AZIMUTH RULE to compute the new azimuth of fire as follows:

| | | |
|---------------------|------------------|------|
| Common deflection | 3200 AZ | 3200 |
| Computed deflection | 4550 Decrease of | 1350 |
| Increase of | 1350 new AZ | 1850 |

| | | |
|---------------------|------------------|------|
| Common deflection | 3200 AZ | 3200 |
| Computed deflection | 2500 increase of | 700 |
| Decrease of | 700 new AZ | 3900 |

Step 5. Replace AZ in AFU;UPDATE with new AZ.

Step 6. Re-execute related fire mission request message (FM; CFF). Data now correspond with common deflection 3200 and appropriate mission data.

APPENDIX G

CANNON SECTION EVALUATION AND TRAINING

G-1 . SCOPE

This appendix is an evaluation and training guide for the howitzer sections of a cannon firing battery. It is universal in scope and can be adapted readily to all cannon weapon systems currently in the Marine Corps and Army inventory. It may be modified by the commander to meet local requirements. It may be administered as follows:

- Formally or informally.
- With minimal administrative support.
- In the local training area.
- In a nonfiring, but tactical environment.

G-2. PURPOSE

a. The evaluation is a performance test of the skills that are essential to the successful accomplishment of the mission of the cannon section. Although many of the tasks are evaluated on the basis of individual performance, the evaluation actually measures the ability of the section to function as a team. The evaluation can be used as follows:

- To evaluate the current state of proficiency of the section.
- As a competitive evaluation to determine the best section in a unit.
- As a basis for a howitzer/gun crew training program in preparation for a formal battery or battalion training evaluation.

b. The tasks laid out in this appendix should be used as training vehicles, with as much time as possible devoted to controlled practice of a task. The sections should practice each task to acquire the degree of proficiency required by the standards set forth in the evaluation.

G-3. CONDUCT OF THE EVALUATION

This evaluation evaluates the ability of the section chief to organize and train his personnel into a cohesive, effective fighting unit. It consists of five phases.

a. **Phase I** is an orientation and organization period beginning with a statement of the purpose, scope, and description of the evaluation. During Phase I, a written test will be administered. This phase should be conducted in a classroom on a day before the test.

b. **Phase II** involves preparation in an assembly area for movement to a location for a deliberate occupation of a prepared position.

c. **Phase III** covers the deliberate occupation of a prepared position.

d. **Phase IV** evaluates the conduct of various types of fire missions.

e. **Phase V** is a critique of the performance of individual sections.

Note: Phases II through IV of the evaluation are constructed around a tactical scenario that can be altered to fit the training resources and the time available.

G-4. EVALUATION FORMAT

a. The **task** is a general statement of the requirement for the particular evaluation.

b. The **conditions** outline the specific environment or situation in which the evaluation will be administered. They state what assistance or reference materials, if any, are authorized and what equipment or personnel are required for proper evaluation.

c. **Evaluation checklists** present the requirements for successful completion of that particular task. Specific technical procedures required in the task will be evaluated by the examiner on the basis of the established procedures in the appropriate reference.

G-5. SCORING

The performance evaluation will be administered within a time framework on a GO/NO-GO basis; the examinee either passes or fails. The examiner will base his judgment upon the criteria stated in the evaluation checklist and on the most current reference for that particular task.

G-6. PREPARATION

All necessary preparations, as indicated in the conditions for each task, will be made before the task begins. The examiner will ensure that the examinee understands the task to be performed.

G-7. QUALIFICATION

a. If the evaluation is administered solely for the purpose of determining the state of training of individual sections within a unit, no formal score is required. The commander can readily determine the strengths and weaknesses of his sections simply by subjectively analyzing the GO and NO-GO ratings received for each task performed.

b. The evaluation may be used to determine the best section in a unit by determining a formal score. To determine the

score for individual sections, add the numerical score attained in each of the four scored phases. See Table G-1 for the qualification scheme.

G-8. ORGANIZATION AND SCORING

The five phases are organized and scored as shown in Table G-2. A recommended grading sheet is shown in Table G-3.

Table G-1. Qualification scheme

| DISTINGUISHED | OUTSTANDING | EXCELLENT | SATISFACTORY | UNQUALIFIED |
|--|-------------|-----------|--------------|-------------|
| 951-1000 | 900-950 | 800-899 | 700-799 | 0-699 |
| Note: Appropriate awards, such as distinctive patches, certificates, and passes, can be given to recognized outstanding and distinguished sections. | | | | |

Table G-2. Organization and scoring

| PHASE | TASK | POSSIBLE POINTS PER PHASE | POSSIBLE POINTS PER TASK PHASE |
|---|--|----------------------------|--------------------------------|
| I | ORIENTATION AND ORGANIZATION Task 1: Written test | 50 | 50 |
| II | PREPARATION FOR FIRING OPERATIONS Task 2: Preparation for deliberate occupation of a prepared position Task 3: Disassembly of breech mechanism Task 4: Assembly of breech mechanism Task 5: Performance of micrometer test on the gunner's quadrant Task 6: Performance of the end-for-end test | 72 49 49 40 40 | 250 |
| III | DELIBERATE OCCUPATION Task 7: Preparation of position by gun guide Task 8: Emplacing the cannon (TLABSPAP) | 80 270 | 350 |
| IV | FIRE MISSIONS Task 9: Conduct of an indirect-fire mission using the GDU Task 10: Preparation of conventional ammunition for firing Task 11: Planned priority targets Task 12: Conduct of direct fire | 120 100 42 88 | 350 |
| V | CRITIQUE | NA | NA |
| | | TOTAL | 1000 |
| Note: The scoring breakdown is a suggested means of evaluating competing sections on a graded basis. The unit may change this scheme to fit its particular situation or training needs and priorities. | | | |

Table G-3. Grading sheet

| CANNON SECTION EVALUATION | |
|---------------------------|-----------------------------|
| UNIT _____ | |
| SECTION _____ | |
| DATE _____ | |
| Section Chief _____ | No 2 Cannoneer _____ |
| Gunner _____ | No 3 Cannoneer _____ |
| Ammo Team Chief _____ | No 4 Cannoneer _____ |
| Assistant Gunner _____ | Driver (Howitzer) _____ |
| No 1 Cannoneer _____ | Driver (Ammo Carrier) _____ |

Phase I Orientation and Organization

TASK 1: Written test

1. Section member scores:
 - Section Chief _____/25 correct
 - Gunner _____/25 correct
 - Ammo Team Chief _____/25 correct
 - Assistant Gunner _____/25 correct
 - No 1 _____/25 correct
 - No 2 _____/25 correct
 - No 3 _____/25 correct
 - No 4 _____/25 correct
 - (Add other personnel as required)
 - Driver (Howitzer) _____/25 correct
 - Driver (Ammo Carrier) _____/25 correct
 2. Section = _____ points/25 correct
 3. Section average $\times 2 =$ _____ points (maximum 50)
- Total Phase I _____ points (maximum 50)

Phase II Preparation for Firing Operations

- TASK 2:** Preparation for deliberate occupation of a prepared position
 9 minus _____ NO-GOs x 8 points + _____ points (maximum 72)
- TASK 3:** Disassembly of breech mechanism
1. NO-GO awarded? Yes = 0 points
 2. If all GOs awarded: Time = _____ = _____ points (maximum 49)
- TASK 4:** Assembly of breech mechanism
1. NO-GO awarded? Yes = 0 points
 2. If all GOs awarded: Time = _____ = _____ points (maximum 49)
- TASK 5:** Performance of micrometer test on the gunner's quadrant
1. NO-GO awarded? Yes = 0 points

2. If all GOs awarded:

Time = _____ = _____ points (maximum 40)

- TASK 6:** Performance of the end-for-end test
1. NO-GOs awarded? Yes = 0 points
 2. If all GOs awarded: Time = _____ = _____ points (maximum 40)
- Total Phase II _____ points (maximum 250)

Phase III - Deliberate Occupation

- Task 7:** Preparation of position by gun guide
 GO ratings x 10 = _____ points (maximum 80)
- Task 8:** Emplacing the cannon
 GO ratings x 27 = _____ points (maximum 270)
- Total Phase III _____ points (maximum 350)

Phase IV - Fire Missions

- Task 9:** Conduct of an indirect-fire mission using the GDU
 120 minus _____ = _____ points (maximum 120)
- Task 10:** Preparation of conventional ammunition for firing
 GO ratings x 10 = _____ points (maximum 100)
- Task 11:** Planned priority targets
 GO ratings x 6 = _____ points (maximum 42)
- Task 12:** Conduct of direct fire
 88 minus _____ = _____ points (maximum 88)
- Total Phase IV _____ points (maximum 350)
- Overall total _____ points (maximum 1000)

Phase V - Critique

During this phase, each problem evaluation area will be critiqued in detail. It is strongly suggested that the section chief for each howitzer take notes on each individual in his section so he will know the strong and weak areas in each task.

G-9. PHASE I, ORIENTATION AND ORGANIZATION

During this phase, preferably conducted on a day before administration of the remaining phases, the following are done.

- All personnel will be briefed as to the conduct and purpose of the training.
- The scoring system will be explained.
- The organization of the training area and general administrative and safety procedures will be explained.
- All questions will be answered.
- The written test will be administered to all section personnel.
- The examiner will be provided a copy to the unit SOP to use during evaluation.

TASK 1: Written test.

Conditions

All section members except the section chief will take the written test. Thirty minutes will be allocated for the test.

Scoring

There is only one correct answer to each question unless otherwise stated. The score of the section members are averaged to determine the section score. Each of the 25 questions is worth 2 points.

General Questions

1. If any member of the battery observes a dangerous situation, he can stop a fire mission already in progress by giving the command--

- a. **STOP FIRING.**
- b. **CANCEL FIRING.**
- c. **CEASE FIRE.**
- d. **CHECK FIRING.**

2. For best results, the collimator should be emplaced how many meters from the howitzer?

- a. 0 to 15
- b. 3 to 10
- c. 3 to 13
- d. 5 to 12

3. In a fire command, the number 3167 is pronounced--

- a. thir-tee wun six-tee seven.
- b. thuh-ree thousand wun six seven.
- c. thuh-ree wun six seven.
- d. three thousand wun hundred six-tee seven.

4. Number 2 wants the FDC to repeat the deflection. Number 2 should say--

- a. **REPEAT DEFLECTION, NUMBER 2.**
- b. **NUMBER 2, DEFLECTION?.**
- c. **DEFLECTION, NUMBER 2.**
- d. **SAY AGAIN DEFLECTION, NUMBER 2.**

5. When separate-loading ammunition is being fired, the fire command for lot includes two letters, XY. The ammunition component(s) represented by the letter X in lot XY is(are)--

- a. propellant.
- b. projectile.
- c. propellant and projectile.
- d. propellant, projectile, and fuze.

6. When storing ammunition, what is the minimum number of inches of dunnage that should be under the ammunition?

- a. 5
- b. 6
- c. 12

7. How should a WP projectile be stored?

- a. On its side and rotated every few hours.
- b. On its base.
- c. The same as an HC projectile.

8. How should you segregate the ammunition in the firing battery area?

- a. by size, color, and weight
- b. by type, lot, and weight zone
- c. by fuze type, lot, and zone

9. Field artillery cannon ammunition is classified according to type as--

- a. fixed and separate.
- b. separate and separate loading.
- c. semifixed and separate loading.
- d. separate loading and fixed.

10. To set an M557 PD fuze for delay action, the correct tool is the--

- a. M63 fuze setter.
- b. P-38.
- c. M 16 fuze wrench.
- d. M 18 fuze wrench.

11. To prepare an M557 PD fuze for delay action, you must first--

- a. rotate the selector setting screw to the horizontal position.
- b. rotate the fuze body to the proper setting.
- c. put a supplementary charge in the proper setting.
- d. move the interrupter out of the flash channel.

12. A misfire occurs. You have waited 2 minutes before removing and inspecting the primer. The primer is dented and has fired. How long must you wait before you open the breech?
- 2 minutes.
 - 5 minutes.
 - 8 minutes.
 - 10 minutes.
13. The type of fuze that can detonate the projectile in the air at a predetermined height above the ground is the--
- superquick fuze.
 - concrete-piercing fuze.
 - proximity fuze (VT).
14. If the MTSQ fuze M564 (dated 1970) is to be used for superquick impact action, the fuze may be set at--
- 90.0.
 - 95.5.
 - 98.0.
 - S.
15. A misfire occurs. You find that the primer is not dented. You know that the cause of the malfunction is a defective--
- powder charge.
 - firing mechanism.
 - primer.
 - igniting charge.
16. The fuze wrench used to seat and tighten a fuze into a standard HE projectile is the--
- M18.
 - M27.
 - M34.
 - M63.
17. The only primer authorized to be used with the M185 cannon tube is the--
- M82.
 - MK2A4.
 - M2.
 - M18A1.
18. The threaded steel plug that facilitates the handling of separate-loading projectiles is called the--
- closing plug.
 - nose plug.
 - eyebolt lifting plug.
 - fuze plug.
19. When the distant aiming point method of boresighting is used, the minimum distance between the aiming point and the weapon should be--
- 1,300 meters.
 - 1,400 meters.
 - 1,500 meters.
 - 7,200 meters.
20. In boresighting by the testing target method, the testing target must be located at least how many meters in front of the howitzer?
- 4-15
 - 50
 - 60
 - 100
21. On a weapon that fires separate-loading ammunition, excessive blowback around the breechblock may mean the split rings are less than 180° apart.
- True
 - False
22. Fire control alignment tests should be performed--
- at the discretion of the battery commander.
 - every 3 months when firing or once each year if no firing takes place.
 - when fires are inaccurate for no apparent reason.
 - at all of the above times.
23. When should you record information on the DA Form 4513?
- after each mission
 - after the day's firing is done
 - when you get back to the motorpool
 - after any fire mission data are received
24. Boresight should be verified every--
- mission.
 - occupation.
 - year.
 - week.
25. If you can't emplace aiming posts at 50 and 100 meters, what should you do?
- don't emplace aiming posts.
 - put both out as far as you can.
 - emplace the far aiming post as far as you can, and the near aiming post half that distance.
 - use a tree and the near aiming post.

G-10. PHASE II, PREPARATION FOR FIRING OPERATIONS

TASK 2: Preparation for deliberate occupation of a prepared position.

Conditions

The chief of section is in the unit motor pool with his crew. The evaluator reads him the following situation.

YOUR SECTION IS PREPARING TO DEPART THE UNIT MOTOR POOL FOR A DELIBERATE OCCUPATION OF A FIRING POSITION. THE GUNNERY SERGEANT HAS JUST INFORMED YOU THAT THE ADVANCE PARTY WILL LEAVE IN 15 MINUTES AND THAT HE WANTS A GUN GUIDE FROM YOUR SECTION READY TO LEAVE AT THAT TIME. THE PLATOON SERGEANT HAS ALSO TOLD YOU THAT THE MAIN BODY WILL DEPART IN 30 MINUTES AND THAT YOUR SECTION SHOULD MAKE ALL NECESSARY PREPARATIONS FOR THE MOVEMENT. TO INCLUDE THE BEFORE-OPERATION CHECKS AND SERVICES ON THE CANNON AND PRIME MOVER/CARGO CARRIER.

Evaluation Checklist

Did the section have all section equipment installed or stowed in accordance with all applicable manuals and unit loading plans?

Were all necessary items on hand for performing the before-operation checks and services on the cannon and prime mover or cargo carrier (for example, basic issue items, operator's manuals with changes, lubrication orders with changes, DA Forms 2404 or DA 5988E, cleaning materials, and logbooks)?

Were the headings of two DA Forms 2404 or DA 5988E completed properly for the conduct of a daily inspection on the cannon and primer mover or cargo carrier?

Did the chief of section use all crew members present to inspect both the cannon and the prime mover or cargo carrier in accordance with the TM?

Did the section inspect each item listed in the Before column of the preventive maintenance checks and services (PMCS) tables of the operator's manuals for the cannon and primer mover or cargo carrier?

Did the section correct all faults discovered that they were authorized to correct in accordance with the PMCS tables and troubleshooting tables of the operator's manuals for the cannon and primer mover or cargo carrier?

| GO | NO-GO |
|----|-------|
| | |
| | |
| | |
| | |
| | |
| | |

Did the section use DA Forms 2404 or DA 5988E to list all faults that they were not able to correct and that were not already listed on the DA Forms 2408-14 or DA 5988E (Uncorrected Faults Record) for the cannon and prime mover or cargo carrier?

Was the gun guide ready to depart with all necessary equipment according to SOP at the time prescribed?

| GO | NO-GO |
|----|-------|
| | |
| | |

Scoring:

For each GO rating, 9 points will be awarded, for a maximum of 72 points.

For each NO-GO rating, 0 points will be awarded.

TASK 3: Disassembly of breech mechanism. (See appropriate Tracked Tasks.)

Conditions:

After giving the howitzer section approximately 30 minutes to complete task 2 above, the evaluator reads the following situation to the chief of section.

DURING THE CONDUCT OF THE BEFORE-OPERATION CHECKS AND SERVICES ON YOUR CANNON, YOU NOTED A MALFUNCTION IN THE BREECH MECHANISM. TO TROUBLESHOOT THE EXACT CAUSE, YOU DECIDE THAT YOU MUST DISASSEMBLE THE BREECH MECHANISM. YOU MAY SELECT ANY MEMBER(S) OF YOUR SECTION TO PERFORM THIS TASK. HOWEVER, YOU MAY NOT PHYSICALLY PERFORM ANY ACTION. YOU HAVE 1 MINUTE TO SELECT THE SECTION MEMBER(S) TO PERFORM THIS TASK AND ASSEMBLE ALL REQUIRED TOOLS AND MANUALS.

At the end of 1 minute, the evaluator gives the following instructions to the section member(s) performing the task:

YOU ARE TO DISASSEMBLE THE BREECH MECHANISM, TO INCLUDE REMOVAL OF BREECHBLOCK, DISASSEMBLY OF FIRING MECHANISM, AND DISASSEMBLY OF OBTURATOR GROUP (AS APPLICABLE), EVEN THOUGH THIS IS A TIMED EXERCISE, PERFORM ALL ACTIONS IN THE PRESCRIBED SAFE MANNER. ARE YOU READY? . . . GO!

Evaluation Checklist

Were the breechblock obturator group, and firing mechanism (as applicable) disassembled in accordance with the appropriate operator's manual?

| GO | NO-GO |
|----|-------|
| | |

Scoring

If a GO rating is awarded, the disassembly will be graded according to speed of execution (Table G-4).

If a NO-GO rating is awarded, 0 points will be awarded for this task.

Table G-4. Scoring—breech mechanism disassembly

| M198 | M101A1 | M102/M119A1 | M109 SERIES | POINTS |
|--|------------------|------------------|------------------|--------|
| 0-3:30 | 0-1:00 | 0-3:00 | 0-3:45 | 49 |
| 3:31-4:00 | 1:01-1:15 | 3:01-3:25 | 3:46-4:05 | 36 |
| 4:01-4:20 | 1:16-1:25 | 3:26-3:40 | 4:06-4:20 | 24 |
| 4:21-10:00 | 1:26-2:30 | 3:41-8:00 | 4:21-8:00 | 12 |
| Longer than 10:00 | Longer than 2:30 | Longer than 8:00 | Longer than 8:00 | 0 |
| Note: Times are in minutes and seconds. | | | | |

TASK 4: Assembly of breech mechanism, (See appropriate tracked tasks.)

Conditions

After evaluating task 3, the evaluator should read the following to the chief of section and the section member(s) previously selected for disassembly of the breech:

ASSUME THAT YOU HAVE REPAIRED THE MALFUNCTION IN THE BREECH MECHANISM. AT THIS TIME, YOU WILL BE EVALUATED ON YOUR ABILITY TO REASSEMBLE THE BREECH MECHANISM TO ITS ORIGINAL CONFIGURATION. ARE YOU READY?... GO!

Evaluation Checklist

Was the breech mechanism properly assembled in accordance with the appropriate operator's manual?

| GO | NO-GO |
|----|-------|
| | |

Scoring

If a GO rating is awarded, the assembly will be graded according to speed of execution (Table G-5 below).

If a NO-GO rating is awarded, 0 points will be awarded for this task.

Table G-5. Scoring—breech mechanism assembly

| M198 | M101A1 | M102/M119A1 | M109 SERIES | POINTS |
|--|------------------|-------------------|-------------------|--------|
| 0-4:00 | 0-1:45 | 0-3:30 | 0-4:15 | 49 |
| 4:01-4:30 | 1:46-2:00 | 3:31-4:00 | 4:16-4:35 | 36 |
| 4:31-4:50 | 2:01-2:10 | 4:01-4:20 | 4:36-4:50 | 24 |
| 4:51-14:00 | 2:11-4:00 | 4:21-12:00 | 4:51-12:00 | 12 |
| Longer than 14:00 | Longer than 4:00 | Longer than 12:00 | Longer than 12:00 | 0 |
| Note: Times are in minutes and seconds. | | | | |

TASK 5: Performance of the micrometer test on the gunner's quadrant. (061-266-3310).

Conditions

After evaluating task 4, the evaluator reads the following to the howitzer chief of section:

BECAUSE OF RECENT FIRING INACCURACIES, THE PLATOON LEADER HAS TOLD EACH HOWITZER SECTION TO PERFORM THE MICROMETER AND END-FOR-END TESTS ON THEIR GUNNER'S QUADRANTS. YOU (OR ANY OF YOUR SECTION MEMBERS) ARE TO PERFORM THE MICROMETER TEST AND ANNOUNCE ANY ERROR AND CORRECTIVE ACTION. AFTER THE MICROMETER TEST, DO NOT REMOVE THE GUNNER'S QUADRANT FROM THE BREECH UNTIL TOLD TO DO SO BY THE EVALUATOR. ARE YOU READY? . . . GO!

Evaluation Checklist

Did the soldiers follow the correct procedures in performing the micrometer test?

Was the soldier able to determine if the micrometer knob was or was not in error and the action to be taken if it was in error?

| GO | NO-GO |
|----|-------|
| | |
| | |

Scoring

If all GO ratings are awarded, the score will be determined by the speed of execution (Table G-6).

If any NO-GO ratings are awarded, 0 points will be awarded.

Table G-6. Scoring—micrometer test

| TIME (minutes and seconds) | POINTS |
|-------------------------------|--------|
| 0:00-0:30 | 40 |
| 0:31-0:40 | 32 |
| 0:41-0:50 | 24 |
| 0:51-1:00 | 16 |
| Longer than 1:00 | 0 |

TASK 6: Performance of the end-for-end test. (061-266-3311)

Conditions

After evaluating task 5, the evaluator reads the following to the section chief

NOW THAT THE MICROMETER TEST HAS BEEN DONE, YOU (OR ANY MEMBER OF YOUR SECTION) ARE TO PERFORM THE END-FOR-END TEST ON

YOUR GUNNER'S QUADRANT. AT THE CONCLUSION OF THE TEST--

- LEAVE THE GUNNER'S QUADRANT ON THE BREECH.
- ANNOUNCE THE ERROR TO THE EVALUATOR, AND
- ANNOUNCE TO THE EVALUATOR IF THE QUADRANT IS SERVICEABLE OR UNSERVICEABLE.

ARE YOU READY? . . . GO!

Evaluation Checklist

Did the soldier follow the correct procedures in performing the end-for-end test?

Was the correct quadrant error announced?

Was the quadrant declared unserviceable if the error exceeded 0.4 mil or declared serviceable if the error was ±0.4 mil or less?

| GO | NO-GO |
|----|-------|
| | |
| | |
| | |

Scoring

If all GO ratings are awarded, the score for the task will be determined by the speed of execution (Table G-7).

If any NO-GO ratings are awarded, 0 points will be awarded.

Table G-7. Scoring—end-for-end test

| TIME (minutes and seconds) | POINTS |
|-------------------------------|--------|
| 0:00-1:00 | 40 |
| 1:01-1:20 | 33 |
| 1:21-1:30 | 26 |
| 1:31-1:40 | 20 |
| 1:41-1:50 | 13 |
| 1:51-2:00 | 7 |
| Longer than 2:00 | 0 |

G-11. PHASE III, DELIBERATE OCCUPATION

During this phase, the gun guide will prepare a designated location for occupation by the section. The section will move to this location, make a deliberate occupation, and prepare for firing.

TASK 7: Preparation of position by the gun guide. (061-266-1101).

Conditions

The gun guide will be required to prepare a position for a deliberate occupation. Upon his arrival in position, the gun guide will be given a detailed briefing to include the following:

- The specific location for his howitzer.
- The azimuth of fire.
- The location of the wirehead.
- The track plan.
- The defense position.

Upon conclusion of his briefing, he will prepare the position.

Evaluation Checklist

Did the guide--

- Perform a security sweep of the area?
- Have all the equipment required according to Table 2-1 in Chapter 2?
- Emplace the pantel marking stakes in the location designated by the GSG?
- Emplace the guide stakes on the azimuth of fire within 20 mils?
- Establish wire communications with the aiming circle?
- Record the deflection to the pantel marking stakes and measure and record the distance from the aiming circle to his gun position?
- Determine site to crest using the M2 compass and piece-to-crest range?
- Record and report site to crest to the GSG?
- Establish the track plan as directed by the GSG?
- Take up defensive position as directed by the GSG?

| | GO | NO-GO |
|--|----|-------|
| | | |
| | | |
| | | |
| | | |
| | | |
| | | |
| | | |
| | | |
| | | |
| | | |
| | | |
| | | |
| | | |

Scoring

For each GO rating, 8 points will be awarded, for a maximum of 80 points.

For each NO-GO rating, 0 points will be awarded.

TASK 8: Emplacing the cannon. (TLABSPAP)

Conditions

The section is occupying a new position prepared by your advance party.

Evaluation Checklist

Did the driver follow the gun guide at a safe speed and distance?

After stopping in position, did the gun guide report the azimuth of fire and the initial deflection to the chief of section?

Was the weapon emplaced by following the standards in the appropriate technical manual?

Did the gunner use the initial deflection reported by the gun guide?

Were proper commands used during laying, according to Chapter 4?

Were the bubbles centered and correct settings made during laying?

Did the section chief verify the sight picture, laid deflection, and bubbles when the howitzer was laid?

Was the howitzer laid to an accuracy of 0 mils within the time prescribed by the appropriate evaluation standards?

Were the collimator and aiming posts prepared for use while the howitzer was being laid?

Was the collimator emplaced and ready for use as the primary aiming point within 2 minutes after the howitzer was laid for deflection?

Were the aiming posts properly emplaced within 2 minutes?

Was a DAP selected if applicable?

Was the howitzer boresighted by DAP or test target according to the TM (or verified by the use of the appropriate alignment device)?

Was the lay of the howitzer verified by a second aiming circle?

Were prefire checks properly performed in accordance with the appropriate TM?

Was ammunition handled and prepared according to the TM?

Were angle of site and piece-to-crest range verified by the section chief?

Did the section chief report when his section was in order?

Were natural materials, when available, used to help camouflage the section position?

| | GO | NO-GO |
|--|----|-------|
| | | |
| | | |
| | | |
| | | |
| | | |
| | | |
| | | |
| | | |
| | | |
| | | |
| | | |
| | | |
| | | |
| | | |
| | | |
| | | |

Were the range cards prepared for both the howitzer and the secondary armament for primary and supplementary positions?

Was the section gear arranged according to the unit SOP?

Did conditions exist which would make the howitzer unsafe during firing?

Did the howitzer or prime mover driver follow the proper shutdown procedures according to the appropriate TM?

Did the section maintain track discipline and camouflage vehicles, to include all reflective surfaces?

Was the section in the proper uniform throughout the occupation?

Did each section member perform his duty with minimum orders?

| GO | NO-GO |
|----|-------|
| | |
| | |
| | |
| | |
| | |
| | |
| | |

Scoring

For each GO rating, 10 points will be awarded, for a maximum of 270 points.

For each NO-GO rating, 0 points will be awarded.

G-12. PHASE IV, FIRE MISSIONS

TASK 9: Conduct of an indirect-fire mission using the GDU (first fire mission).

Conditions

(See applicable track tasks)

Note: Time standards for fire missions are those listed in the unit MTP, Appendix A.

FDC send data over the GDU.

EXAMPLE

DNL/AMC/FIRE/TEST

| | | | |
|-----------|----------|-------|---------|
| GUN 01 MI | 01RDADJ | SH HE | LOT X/Y |
| CHG 3 | FZ QUICK | T1-0 | DF 2938 |
| QE 348 | | | |

SUBSEQUENT COMMANDS

DF (so much)

QE (so much)

For rounds 2 and 3, the size of the deflection and quadrant shifts from the last round fired are as follows:

- Deflection: 20 to 40 mils.
- Quadrant: 20 to 30 mils.

For rounds 4 and 5, high-angle fire is required. The size of the deflection and quadrant shifts are as follows:

- Deflection: 50 to 80 mils.
- Quadrant 600 to 800 mils.

Note: The tube will be returned to loading elevation after each round is fired (if applicable). The time for each test begins when the section chief states the first word of the command and ends when the appropriate cannoneer has fired the weapon. The cannoneers will perform all of the actions required to fire the weapon, to include using dummy ammunition, if available. Firing is on the command of the section chief.

Evaluation Checklist

Were all bubbles exactly centered when round was fired? (-5 for any unentered bubble)

Was the pantel correctly aligned on aiming point when round was fired? (-5 if not aligned) Did the section chief verify the sight picture before firing?

Were the correct data fired? (-5 for any incorrect data)

Were correct and complete commands issued by all sections members (SET, READY, CLOSE, and so forth)? (-1 for each incorrect or omitted command)

| GO | NO-GO |
|----|-------|
| | |
| | |
| | |
| | |

Scoring

4 missions x 30 points per mission = 120 points possible.

TASK 10: Preparation of conventional ammunition for firing. (061-266-1505/061-266-1506) (second fire mission)

Conditions

Dummy ammunition is available. The section chief is given four 3- by 5-inch cards that require the section to prepare selected nonnuclear ammunition for firing.

Standard data: Tested section is adjusting piece, shell HE, lot XY, fz Q.

EXAMPLE

| | | | |
|------------------|----------|-------|--------|
| DNL/AMC/FIRE/EST | | | |
| GUN | 01RDADJ | SH HE | LOT XY |
| 01M2 | | | |
| CH 3 | FZ QUICK | T1-0 | DF3211 |
| QE 531 | | | |

SUBSEQUENT COMMANDS

Use a different charge and fuze delay.

Evaluation Checklist, Cards 1 and 2

Was ammunition sufficiently protected as dictated by the tactical situation?

Was ammunition prepared in accordance with fire commands?

Were PD-fuzed projectile and propellant prepared as announced?

Were delay-fuzed projectile and propellant prepared as announced?

Was propellant cut to announced charge?

| GO | NO-GO |
|----|-------|
| | |
| | |
| | |
| | |
| | |

SUBSEQUENT COMMANDS

Use different charge, fuze VT, and fuze time with appropriate settings.

Evaluation Checklist, Cards 3 and 4

Was ammunition sufficiently protected as dictated by the tactical situation?

Was ammunition prepared in accordance with fire commands?

Were VT-fuzed projectile and propellant prepared, and was time set to an accuracy of 0 seconds?

Were MTSQ-fuzed projectile and propellant prepared, and was time set to an accuracy of 0.1?

Was propellant cut to announced charge?

| GO | NO-GO |
|----|-------|
| | |
| | |
| | |
| | |
| | |

Scoring

For each GO rating, 10 points will be awarded, for a maximum of 100 points.

For each NO-GO rating, 0 points will awarded.

TASK 11: Planned priority targets (third fire mission).

Conditions

FDC has announced the firing data for planned targets. FDC has designated a priority target from the planned target list. FDC announces the section and target number to be fired.

Evaluation Checklist

Has the section prepared a section data card for planned targets, to include target numbers, shell, lot, fuze time, deflection, and quadrant?

| GO | NO-GO |
|----|-------|
| | |

Was the howitzer laid on the priority target within 30 seconds of the command from FDC?

Was the charge cut?

Was a fuze with appropriate setting mated to the announced projectile?

Was the projectile in the loading tray (if applicable)?

Was the weapon laid for deflection and elevation (loading elevation, if necessary)?

Was the weapon fired within 20 seconds of the command from FDC?

Scoring

For each GO rating, 6 points will be awarded, for a maximum of 42 points.

For each NO-GO rating, 0 points will be awarded.

TASK 12: Conduct of direct fire. (fourth fire mission) (see appropriate track tasks).

Conditions

A stationary target will be emplaced 400 to 800 meters from the howitzer to simulate a moving target. The section chief will be given a series of 3- by 5-inch cards that will require the section to use direct laying procedures. The following sample situation cards may be used for all weapons. The examiner should prepare situation cards that are varied and that avoid routine or similar ranges.

CARD 1

A T62 tank is approaching your battery position and is moving straight toward your howitzer at an estimated range of 600 meters.

CARD 2

The first round fired by your section went over the tank. The tank has now turned and is moving from left to right in front of your position at a speed of 25 mph and at the initial range of 600 meters.

CARD 3

The second round fired by your section was short of the tank and on line. The tank has turned again and is now moving from right to left at a 45° angle going away from your position at a speed of 20 mph.

CARD 4

The tank was hit by your third round but was only partially disabled (however, it is still capable of firing). The gunner and assistant gunner continue to lay and fire on the target until it is destroyed or a subsequent fire command is given by the chief of section.

Evaluation Checklist, Standards, and Scoring

Each situation card is worth a total of 22 points.

Each section should be evaluated on four separate situation cards, for a total of 88 possible points.

Each situation will be evaluated and penalties assessed as shown in Table G-8.

G-13. PHASE V, CRITIQUE

During this phase, conducted as soon after phases II through IV as possible, the following actions are taken:

- All section personnel are thoroughly briefed on the detailed results of the evaluation.
- Outstanding performances are recognized and highlighted.
- Weak areas are critiqued in a constructive manner aimed at establishing specific tasks requiring further training emphasis.
- All questions are answered.

Section feedback should be encouraged in an effort to improve the content, organization, or administration of the evaluation.

Table G-8. **Scoring—direct-fire mission**

| STANDARDS | PENALTY | MAXIMUM POSSIBLE POINTS CUT |
|--|---|-----------------------------|
| The section chief issues correct and complete fire commands within 20 seconds of the receipt of each card, and section members announce correct commands | -1 for each incorrect or omitted fire command or for each command that takes over 20 seconds to issue | -6 |
| The announced lead and range or elevation are set off. | -6 for any incorrect lead or range or elevation | -6 |
| All bubbles are centered when the howitzer is fired. | -2 for each bubble not level | -4 |
| The time from the last digit of range or elevation until the howitzer is fired is 20 seconds or less. | -1 for each second over 10 | -6 |

APPENDIX H

UNIT DEFENSE CHECKLIST

Note: This sample checklist will help the leaders go through a mental review of existing battery or platoon defensive preparations.

H-1. ENTRANCE POINT

The entrance point serves as a means to control traffic flow into and out of the firing position. It does not necessarily serve the same function as an LP and/or OP.

- a. Is the sentry properly posted and given guard orders and special instructions?
- b. Does the sentry know the current challenge and password?
- c. Does the entrance point have communications with the BOC or POC?
- d. Does the entrance point restrict movement into and out of the battery area?
- e. Who will pick up the sentry in an emergency displacement?

H-2. PASSIVE DEFENSIVE TECHNIQUES

Are passive measures being employed by the battery or platoon?

a. After considering factors of METT-T:

(1) What type of THREAT target acquisition assets can be identified across the FLOT (for example, radar, sound, and/or flash)? This may influence the selection of charge(s) to fire.

(2) Is battery or platoon equipment that could be located by radio direction finding dispersed from those susceptible to detection by sound and flash or weapons-locating radars?

(3) Are antennas remoted? Are directional antennas used?

(4) What is the expected air threat?

(5) What is the expected counterfire threat?

(6) What is the expected ground threat?

b. Does the unit display good camouflage discipline?

c. Is battery or platoon equipment sited properly?

d. Has natural camouflage been enhanced and man-made camouflage been constructed?

e. Is the unit using all available cover and concealment?

f. Are the techniques of disguising, hiding, and blending of equipment within the position being applied?

g. Is light and noise discipline being enforced during periods of limited visibility?

h. Is track plan discipline being enforced to limit identifiable vehicle tracks into the position?

i. Are M-8 alarms positioned correctly?

H-3. ACTIVE DEFENSIVE TECHNIQUES

a. Listening and/or Observation Posts.

(1) Are OPs and/or LPs positioned to afford early warning?

(2) Are OP and/or LP locations prepared?

(3) Do OPs and/or LPs have binoculars?

(4) Have OPs been briefed on enemy situation and their responsibilities?

(a) Have range cards been constructed for crew-served weapons and checked by a unit leader to ensure integrated fields of fire?

(b) Have two means of communications been established with the LPs and/or OPs?

(3) Has a system been established to man the OPs and/or LPs on a 24-hour basis?

(4) Has a prearranged signal been established to recall the OP and/or LP?

b. Hardening.

(1) Is key battery equipment (such as ammunition and generators) hardened?

(2) Are available urban terrain, man-made structures, and/or natural terrain features being used to the maximum extent possible?

(3) Are available cover and concealment being used?

c. Fighting Positions.

(1) Have individual fighting positions (IFPs) been established (if required) for every section?

(2) Are IFPs prepared?

(a) Have range cards been constructed for crew-served weapons and checked by a unit leader to ensure integration of frees?

(b) Are individual and section fighting positions dug in?

(c) Has battle site zero been set on all M16 weapons?

(3) Are the IFPs integrated into the overall defensive plan?

(4) Are sufficient crew-served weapons (M60, M2) positioned to provide security for key battery elements?

(a) Are range cards prepared?

(b) Are visibility diagrams prepared?

(c) Have firing stakes been emplaced to identify the primary and alternate sectors of fire? Are they marked for day and night and if so, how?

(d) Have traverse and elevation (T&E) mechanism settings been recorded on range cards?

(e) Have M2 machine guns been headspaced and timed.

(f) Has a final protective line (FPL) been established?

(g) Has a signal been announced for firing the FPL?

(h) Do fields of fire interlock?

(i) Have fields of fire been cleared?

(5) Is the IFP properly camouflaged?

d. Reaction Force.

(1) Has a reaction force been established?

(2) Has a primary and alternate signal and rally point been disseminated?

(3) Have alternates been identified for members of the reaction force?

(4) Has the RF been rehearsed?

(5) Does the reaction force have a means of communication?

(6) Has the reaction force been briefed for the tactical situation?

H-4. PERIMETER COMMUNICATIONS

a. Have wire communications been established within the battery perimeter?

b. Do key battery elements have wire communications?

c. Does the entrance point have communications?

d. Does the battery have alarm signals for the following types of attack?

(1) NBC?

(2) Air?

(3) Counterfire?

(4) Ground?

e. Is the wire buried to withstand attack and friendly vehicle movement?

H-5. ANTIARMOR ASSETS

a. Have tank-killer teams been designated?

b. Have likely engagement areas and hide positions been selected?

c. Have supplementary positions been reconnoitered and prepared?

d. Has the plan been rehearsed?

e. Have the tank-killer teams been briefed for the tactical situation?

H-6. MOVEMENT

a. Has the battery commander or platoon leader planned mutually supporting indirect frees in support of his movement plan and provided this information to higher headquarters?

b. Has the battery commander or GSG selected and reconnoitered an alternate position?

c. Have rally points been established?

d. Have the rally points location and route of egress been disseminated?

e. Has the alternate position been prepared?

f. Have organic mine detectors been used during the route reconnaissance?

g. Have convoy signals been established for the following:

(1) Blocked ambush?

(2) Unblocked ambush?

(3) Air attack?

(4) Artillery attack?

(5) Emergency occupation? (See STANAG 2047 on this topic.)

(6) Are the vehicles prepared for the tactical situation and is security available?

H-7. LOCAL SECURITY

a. Have local patrols been deployed, if necessary? (See FM 7-8, Chapter 3, on this topic.)

b. Have obstacles been integrated into the defensive plan?

c. Has a defensive diagram been prepared?

(1) Has prominent terrain been indicated?

(2) Have mines and/or barriers been annotated?

(3) Are primary and supplementary positions marked?

(4) Are direct fire sectors marked? Day and night?

(5) Are interlocking fields of fire and the FPL marked?

(6) Are OPs and LPs with delay and withdrawal plans included in the defensive diagram?

(7) Is dead space annotated and covered?

(8) Have target reference points (TRPs) been established and marked? Day and night?

(9) Have avenues of approach been identified?

(10) Have Killer Junior targets been identified; data computed and disseminated?

d. Has the battery commander or platoon leader planned indirect fires in support of his defensive plan?

e. Has the challenge and password been issued to all personnel?

f. Have friendly unit locations been identified and disseminated to avoid fratricide?

g. Does everyone know the threat?

H-8. NUCLEAR, BIOLOGICAL AND CHEMICAL

a. Are chemical agent detectors situated upwind of the battery position?

b. Are detectors placed far enough from the unit to provide adequate warning?

c. Have detectors been relocated as wind direction changed?

d. Have detector alarms been tested?

e. Have detector alarms been located to afford security and control?

f. Has a MOPP level been established?

g. Do sections have complete chemical protective overgarments (CPOG) on hand? Filter replacements? M258A1 kits? M256 kits? Chemical agent monitor (CAM)?

h. Does the battery have survey and monitoring teams? Have the teams been rehearsed?

i. Are the M256 detection kits being used by trained teams? Is M8 or M9 paper being used by individual soldiers?

j. Are the AN/PDR-27J, IM-174 and IM-93 radiac meters on hand? Do they work?

k. Is the unit prepared to conduct personal decontamination? Have personnel been designated and trained?

l. Is the unit prepared to conduct limited equipment decontamination? Have personnel been designated and trained? Does the unit have all authorized M13s?

m. Does the battery have alarm signals for the NBC attacks?

n. Does the unit have an EMP defense plan for electronic equipment?

o. Is the unit maintaining an operational exposure guide (OEG)?

p. Have unmasking procedures been rehearsed?

q. Has an alternate soldier been chosen for unmasking procedures?

H-9. AIR DEFENSE COVERAGE

a. Has the S3 established priorities of air defense coverage to the battalion? Has the air defense warning status/weapon status been disseminated?

b. Has the battery or platoon been integrated into the air defense coverage?

c. What percentage of available M2 machine guns are deployed in a ground-mount vice ring-mount configuration?

d. How does the battery plan on providing air defense coverage with organic assets while in position?

- e. Has the battery/platoon plan been rehearsed?
- f. What are the primary and alternate signals?

H-10. MEDICAL

a. What is the plan for the evacuation of casualties to the battalion aid station? Have litter teams and evacuation vehicles been identified? Has the 1SG or alternate rehearsed the route (day and night, MOPP IV)? Have maneuver aid stations/ambulance exchange points been identified and briefed?

b. What is the plan to provide organic first aid during combat operations? Are combat lifesavers properly trained and positioned throughout the unit? Has an alternate soldier been chosen for unmasking procedures? Are litters properly placed by SOP? Are triage and casualty collection points established and briefed?

c. Has a landing zone been identified for MEDIVAC aircraft?

d. Are combat service support (CSS) graphics on hand and posted in the BOC/POC? Are they current?

e. Where do corpsmen/medics go when the signal for the reaction force, or any signal, is given?

H-11. ENEMY PRISONERS OF WAR (EPWs)

a. Are EPW collection points established?

b. Is there a plan for evacuation/treatment of EPWs?

c. Has the plan been rehearsed?

d. Who has primary responsibility for the EPWs?

APPENDIX I

KILLER JUNIOR

I-1. DESCRIPTION

The following description of killer junior is given by Major General David Ewing Ott in *Vietnam Studies, Field Artillery, 1954-1973* (Washington, D.C., US Government Printing Office, 1975), page 61, paragraph 4:

“Another effective direct fire technique was Killer Junior. The technique was designed to defend fire bases against enemy ground attack and used mechanical time-fuzed projectiles set to burst approximately 30 feet off the ground at ranges of 200 to 1,000 meters.” “This technique proved more effective in many instances than direct fire with Beehive ammunition because the enemy could avoid Beehive by lying prone or crawling. Another successful application of the Killer technique was in clearing snipers from around base areas. The name Killer came from the radio call sign of the battalion that perfected the technique. To speed the delivery of fire, the crew of each weapon used a firing table containing the quadrant, fuze settings, and charge appropriate for each range at which direct fire targets could be acquired.”

I-2. TYPES OF TARGETS

The most likely target for which Killer Junior would be used is dismounted infantry. Careful consideration must be given to weapon positioning to maximize fields of fire, and to complement other organic or attached weapon systems.

I-3. AMMUNITION

a. Shell-Fuze Combination. Shell HE is fired with mechanical time super quick fuze M564/M582.

Note: Minimum fuze setting authorized for these fuzes is 2.0 (reference TM 43-0001-28).

b. Charges. Minimum authorized charge should be fired to facilitate the engagement of targets at close range. If the maximum charge is used, it will serve only to increase the range-to-fuze function.

I-4. PROCEDURES

a. Sighting. The three primary methods of sighting outlined in Chapter 8 are used when firing Killer Junior.

b. Firing data.

(1) 105-mm. Pocket-size firing tables for charge 1, shell HE, fuze MTSQ can be ordered through normal publication channels.

Note: These tables are incorrect in that they do not contain the warning shown below.

WARNING

Firing a fuze setting less than what corresponds to a range of 650 meters is restricted to combat emergency conditions only. Firing a fuze setting less than this value results in a danger close hazard to the crew. Also, the fuzes, except for the M577 and the M582, require about 400 meters to arm (2.0 seconds). The M577 and M582 fuzes, when set for a time of less than 4 seconds, will allow the fuze rotor to release almost immediately. This fully arms the fuze, which enables the fuze to explode at the set time. Any time setting of less than 2 seconds is a danger to the crew and should not be fired unless firing Killer Junior.

(2) 155-mm. Direct fire tables are not available in current firing tables; therefore, battery personnel must compute the data. The data are produced for quadrant elevation, fuze setting, and 10/R factor (10 divided by range in thousands) for the minimum authorized charges. The quadrant elevation, when used with the listed fuze setting, will produce an airburst of 10 meters above and before the listed range. Compute data as discussed below.

WARNING

Firing a fuze setting less than what corresponds to a range of 750 meters for 155-mm is restricted to combat emergency conditions only. Firing a fuze setting less than this value results in a danger close hazard to the crew. (Refer to AR 385-63, Chapter 11, Table 11-1.) Also, the fuzes require about 400 meters to arm (2.0 seconds). The M577 and M582 fuzes, when set for a time of less than 4 seconds, will allow the fuze rotor to release almost immediately. This fully arms the fuze, which enables the fuze to explode at the set time. Anytime setting of less than 2 seconds is a danger to the crew and should not be fired unless firing Killer Junior.

Note: For howitzers firing separate-loading ammunition, direct fire tables should be produced for both green bag and white bag propellants.

(a) Format a Killer Junior table as shown in Figure I-1. Label it with the charge to be fired. Column 1 is range in meters. Column 2 is quadrant elevation in mils. Column 3 is fuze setting. Column 4 is 10/R in mils.

| SHELL HE, M107 FUZE MTSQ M564/M582 | | KILLER JUNIOR DIRECT FIRE | | CHARGE 2 | |
|---|---------------------------------|------------------------------------|----------------|----------|--|
| 1 | 2 | 3 | 4 | | |
| RANGE (METERS) | QUADRANT ELEVATION (MILS) | FUZE SETTING | 10/R (MILS) | | |
| | | | | | |
| | | | | | |
| | | | | | |

Figure I-1. Killer Junior direct fire table format

(b) Using the appropriate firing table, enter the minimum authorized charge, Table F.

(c) Enter ranges in column 1 in increments of 100 meters from--

- The minimum range corresponding to 2.0 fuze setting for graze burst. (Example: 203mm, charge 1 green bag; minimum range used would be 500 meters).
- Maximum range is 1,500 meters.

(d) Calculate 10/R factor for listed ranges, and enter it in column 4.

Note: 10/R factor should be listed to the nearest whole mil to simplify uses for howitzer crew members.

(e) Add 10/R factor to the elevation listed in the firing table, and enter the sum to the nearest whole mil in column 2.

Note: An additional value of 10/R should be applied to compensate for each 10-meter difference in vertical interval (VI) between the target and the howitzer.

(f) Subtract 0.1 fuze setting increments from the fuze setting for graze burst. Enter that number in column 3.

EXAMPLE

You are in an M198 (155mm) howitzer firing battery. Minimum authorized charges are charge 2 green bag and charge 3 white bag. Authorized firing tables for your unit are on hand.

Step 1. Format the Killer Junior direct fire table for charge 2. (An M198 firing charge 2 may result in a round lodged in the tube or early functioning if using fuze M564.)

Step 2. Compute 10/R factor for ranges 500 to 1,500 meters. Using artillery expression, express to the nearest whole mil. Range 500 (when data are input in column 4, express to the nearest whole mil); $10/0.5=20$ mils. Range: $900\ 10/0.9 = 11.1$ mils. Range $1300\ 10/1.3=7.7$ mils.

Step 3. Add 10/R factor to elevation corresponding to listed range. Using artillery expression, express to the nearest whole mil.

Range 500: $45.4 + 20 = 65.4$ or 65 mils

Range 900: $82.8 + 11.1 = 93.9$ or 94 mils

Range 1300 $121.6 + 7.7 = 129.3$ or 129 mils

Step 4. Subtract 0.1 fuze setting increments from the listed fuze setting for a graze burst.

Range 500: $2.1 - 0.1 = 2.0$

Range 900: $3.8 - 0.1 = 3.7$

Range 1300: $5.6 - 0.1 = 5.5$

APPENDIX J
CRATER ANALYSIS AND REPORTING

J-1. CRATER ANALYSIS TEAM

Although greater reliance should be placed on reports from trained teams, all personnel should know how to analyze craters and make the proper report. Since crater analysis teams are not authorized by TOE, each unit (including units normally located in rear areas) should select and train at least one team of two or three members. To adequately support their maneuver unit, fire support personnel must know how to analyze and report crater information.

J-2. EQUIPMENT

Three elements—direction, dimensions, and curvature—must be measured for crater analysis. The equipment used by the crater analysis team should consist of the following items:

- Declinated aiming circle (or M2 compass), stakes, and communications wire used to obtain the direction from the crater to the weapon that fired the projectile.
- A curvature template (Figure J-1) to measure the curvature of the fragment to determine the caliber of the shell. The template can be constructed of heavy cardboard, acetate, wood, or other appropriate material.
- Defense Intelligence Agency Projectile Fragment Identification Guide (DST-1160G-029-85) for measuring fragment dimensions.

J-3. SHELL CRATER ANALYSIS

a. The projectile direction of flight can be determined with reasonable accuracy from its crater or ricochet furrow. By accurately locating the crater and determining the direction of flight, it is possible to obtain the azimuth of a ray that will pass through or near the enemy position. While it is possible to determine the direction to a battery from one crater or ricochet furrow, the battery may be located by plotting the intersection of the average azimuths from at least three widely separated groups of craters.

b. In crater analysis, differences in angle of fall, projectile burst patterns, directions of flight, and time fuze settings will help to distinguish between enemy batteries firing on a given area.

Note: Refer to FM 3-100 for guidance on friendly troop safety from the effects of craters contaminated with chemical agents. Refer to STANAG 2002 in FM 3-100 for guidance in marking craters containing chemical, biological, or radiological contamination.

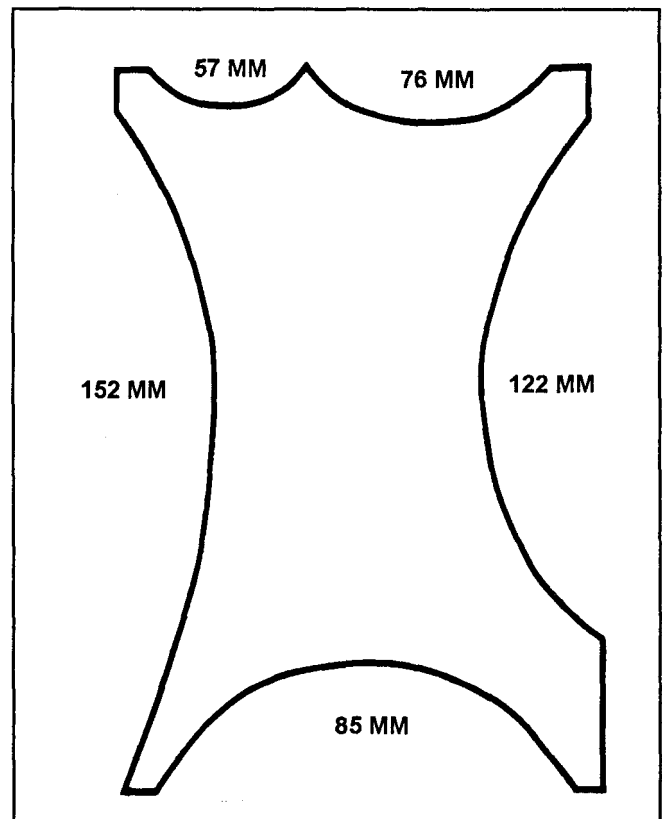

Figure J-1. Curvature template

J-4. VALUE OF ANALYSIS

By analyzing shell craters, it is possible to do the following:

- Verify as confined locations, suspected locations that have been obtained by other means.
- Confirm the presence of enemy artillery and obtain an approximate direction to it.
- Detect the presence of new types of enemy weapons, new calibers, or new ammunition manufacturing methods.

J-5. INSPECTION OF SHELLED AREAS

Shelled areas are inspected as soon as possible. Craters that are exposed to the elements or are abused by personnel deteriorate rapidly thereby losing their value as a source of information.

J-6. SURVEY OF CRATER LOCATION

Areas must be located accurately enough for plotting on charts, maps, or aerial photographs. Deliberate survey is not essential; hasty survey techniques or map spotting usually will suffice. Direction can be determined by use of an aiming circle or a compass.

J-7. DETERMINATION OF DIRECTION

a. Pattern. A clear pattern produced on the ground by the detonating shell indicates the direction from which the shell came.

b. Factors Affecting Pattern. Because of terrain irregularities and soil conditions, typical shell crater patterns are the exception, not the rule. Side spray marks are a principal part of the pattern caused by fragmentation. There is much less effect from nose spray. Base spray is negligible from gun and howitzer projectiles but is appreciable from mortars. The width, angle, and density of the side spray pattern vary with the projectile, the angle of impact, the type of fuze, terminal velocity of the projectile, and soil composition. In determining direction, the following are considered:

- The effect of stones, vegetation, stumps, and roots in the path of the projectiles.
- Variations in density and type of soil.
- The slope of the terrain at the point of impact.

From any group, only the most clearly defined and typical craters are used.

c. Marks on Vegetation and Other Objects. The direction from which a round was fired is often indicated by the marks made as it passes through trees, snow, and walls. The possible deflection of the shell upon impact with these objects must be considered. Evidence of such deflection should not be overlooked.

d. Drift and Wind Effects. Drift and lateral wind effects do not materially change the direction of the axis of the shell during flight.

e. Ricochet Furrows. Often when an artillery round with a delay fuze is fired at low angle, it bounces or ricochets from the surface of the earth. In doing so, it creates a groove, called a ricochet furrow, which is an extension of the plane of fire. Care must be taken, however, to determine that the shell was not deflected before or while making the furrow.

J-8. CRATER ANALYSIS

The first step in crater analysis is to locate a usable crater for determining the direction to the hostile weapon. The crater should be clearly defined on the ground and should be reasonably fresh. Since the crater is the beginning point for plotting the direction to the enemy weapon, the grid coordinates of the crater should be determined as an eight-digit grid, or as precisely as time and method used will allow. The direction to the firing weapon must be determined by one of the methods described in the following paragraphs. Shell fragments and fuzes must be collected for use in identifying the type, caliber, and country that manufactured the weapon and/or projectile.

J-9. LOW-ANGLE FUZE QUICK CRATERS (ARTILLERY)

The detonation of a projectile causes an inner crater. The burst and momentum of the shell carry the effect forward and to the sides, forming an arrow which points to the rear (toward the weapon from which the round was fired). The fuze continues along the line of flight, creating a fuze furrow. There are two methods of obtaining a direction to a hostile weapon from this type of crater. The best results are obtained by determining a mean, or average, of several directions obtained by using both methods.

a. Fuze Furrow and Center-of-Crater Method. In this method, stakes are placed in the center of crater and in the fuze furrow. Then the direction is measured to the hostile weapon. (See Figure J-2.) A variation of this method is to place a stake where the shell entered the ground instead of

the fuze furrow and determine the direction in the same manner. This method is rarely possible, however, since indications of the point of entry are usually destroyed by the explosion of the shell. The five steps of this method are as follows:

- Place a stake in the center of the crater.
- Place a second stake in the fuze furrow at the point where the fuze was blown forward to the front of the crater.
- Setup direction-measuring instrument in line with the stakes and away from fragments.
- Orient the instrument.
- Measure the direction to the hostile weapon.

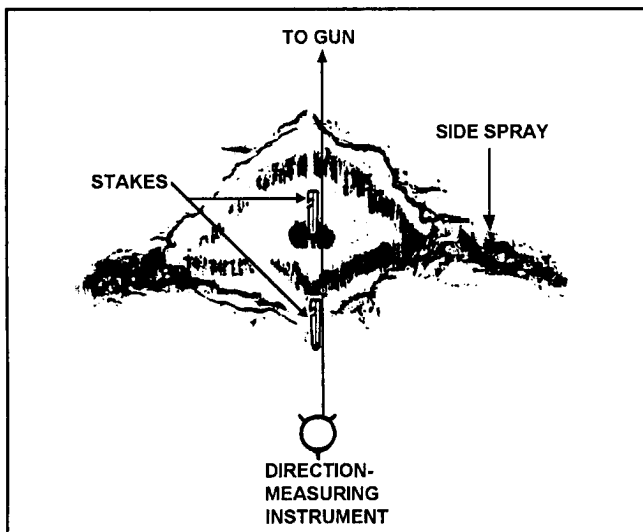

Figure J-2. Fuze furrow and center-of-crater method

b. Side-Spray Method. Another method to measure the direction to a hostile weapon is to bisect the angle formed by the lines of side spray. (Figure J-3.) The seven steps in the side spray method are as follows:

- Place a stake in the center of the crater.
- Place two stakes, one at the end of each line of side spray, equidistant from the center stake.
- Hold a length of communications wire (or another appropriate field-expedient means) to each side spray stake, and strike an arc forward of the fuze furrow.
- Place a stake where these arcs intersect.
- Set up a direction-measuring instrument in line with the center stake and the stake at the intersection of the arcs.

- Orient the instrument.
- Measure the direction to the firing weapon.

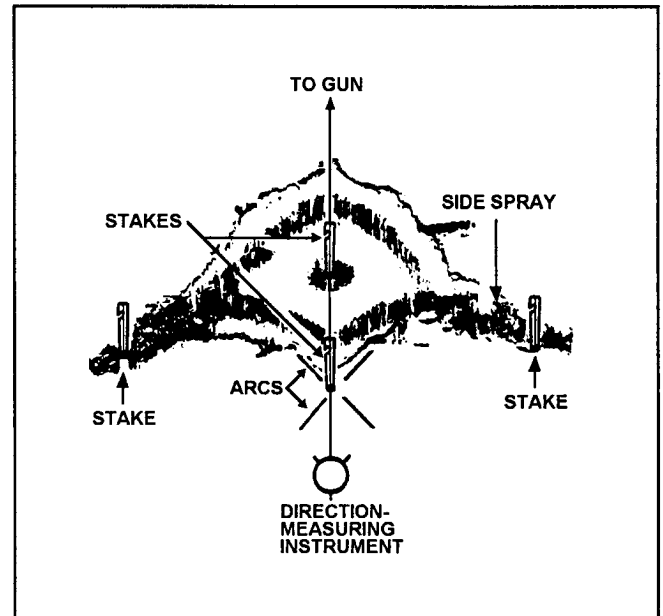

Figure J-3. Side-spray method

J-10. LOW-ANGLE FUZE DELAY CRATERS (ARTILLERY)

There are two types of fuze delay craters: ricochet and mine action.

a. Ricochet. The projectile enters the ground in line following the trajectory and continues in a straight line for a few feet, causing a ricochet furrow. The projectile normally deflects upward and, at the same time, it changes direction usually to the right as the result of the spin, or rotation, of the projectile. The effect of the airburst can be noted on the ground. Directions obtained from ricochet craters are considered to be the most reliable. The five steps to determine direction from a ricochet furrow (Figure J-4) are as follows:

- Clean out the furrow.
- Place stakes at each end of a usable straight section of the furrow.
- Set up a direction-measuring instrument in line with the stakes and away from fragments.
- Orient the instrument.
- Measure the direction to the weapon.

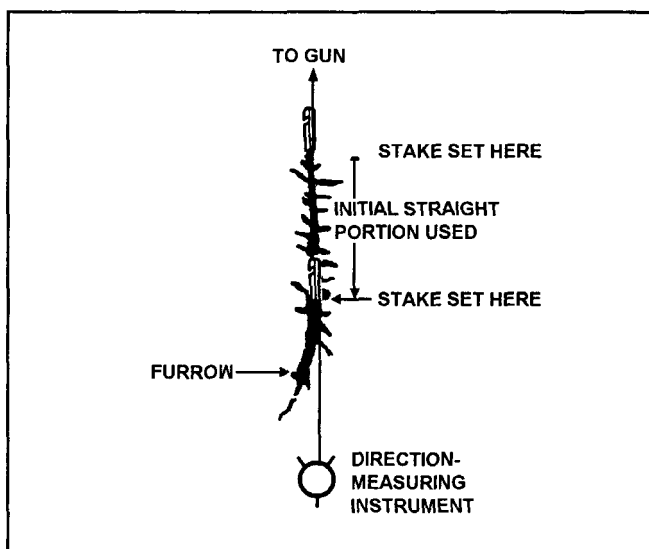

Figure J-4. Ricochet furrow method

b. Mine Action. This occurs when a shell burst beneath the ground. Occasionally, such a burst will leave a furrow which can be analyzed in the same manner as the ricochet furrow. A mine action crater which does not have furrow cannot be used to determine the direction to the weapon.

J-11. HIGH-ANGLE SHELL CRATERS (MORTARS)

In a typical mortar crater, the turf at the forward edge (the direction away from the hostile mortar) is undercut. The rear edge of the crater is shorn of vegetation and grooved by splinters. When fresh, the crater is covered with loose earth, which must be carefully removed to disclose the firm, burnt inner crater. The ground surrounding the crater is streaked by splinter grooves that radiate from the point of detonation. The ends of the splinter grooves on the rearward side are on an approximately straight line. This line is perpendicular to the line of flight if the crater is on level ground or on a slope with contours perpendicular to the plane of fire. A fuze tunnel is caused by the fuze burying itself at the bottom of the inner crater in front of the point of detonation. Three methods may be used to determine direction from a mortar shell crater—the main axis, splinter groove, and fuze tunnel methods.

a. Main Axis Method. The four steps to determine direction by the main axis method (Figure J-5) are as follows:

- Lay a stake along the main axis of the crater, dividing the crater into symmetrical halves. The stake points in the direction of the mortar.

- Set up a direction-measuring instrument in line with the stake and away from fragments.
- Orient the instrument.
- Measure the direction to the weapon.

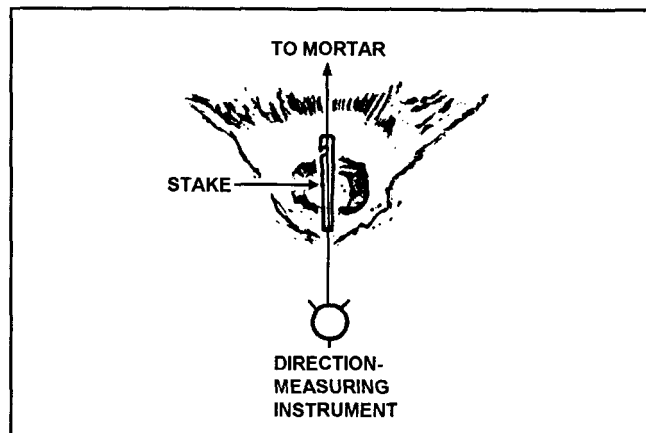

Figure J-5. Main axis method

b. Splinter Groove Method. The five steps to determine direction by the splinter groove method (Figure J-6) are as follows:

- Lay a stake along the ends of the splinter grooves that extend from the crater.
- Lay a second stake perpendicular to the first stake through the axis of the fuze tunnel.
- Set up a direction-measuring instrument in line with the second stake and away from fragments.
- Orient the instrument.
- Measure the direction to the weapon.

c. Fuze Tunnel Method. The four steps to determine direction by the fuze tunnel method (Figure J-7) are as follows:

- Place a stake in the fuze tunnel.
- Set up a direction-measuring instrument in line with the stake and away from fragments.
- Orient the instrument.
- Measure the direction to the weapon.

Note: If the angle of fall is too great (a 90° angle), the fuze tunnel method cannot be used.

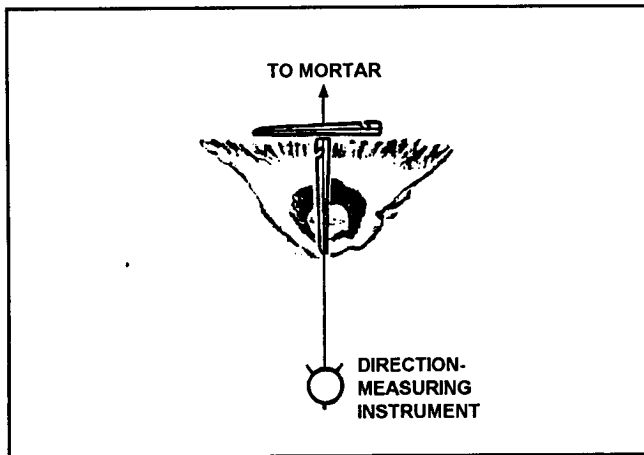

Figure J-6. Splinter groove method

J-12. ROCKET CRATERS

A crater resulting from a rocket impacting with a low or medium angle of fall is analyzed in the same manner as an artillery crater resulting from a projectile armed with fuze quick. However, if the rocket impacts with a high angle of fall, the crater is analyzed in the same manner as a crater resulting from a mortar round. The tail fins, rocket motor, body, and other parts of the rocket, may be used to determine the caliber and type of rocket fired.

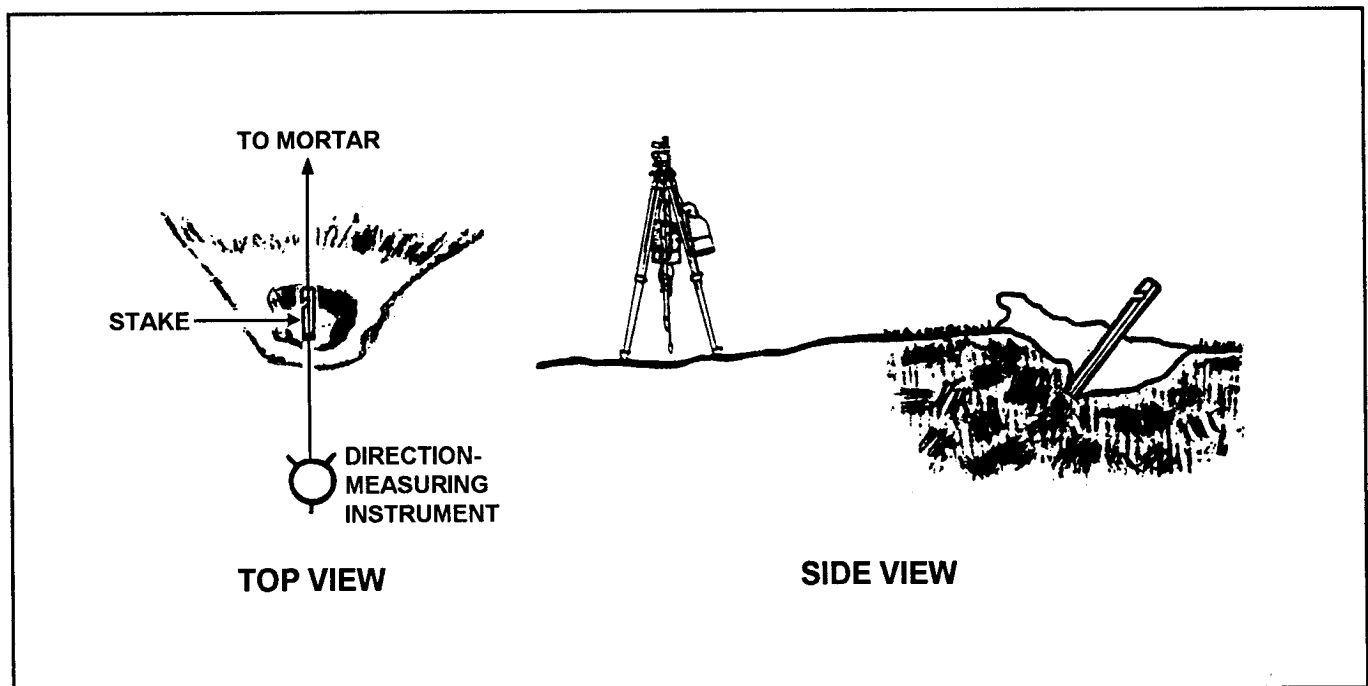

Figure J-7. Fuze tunnel method

J-13. SHELL FRAGMENT ANALYSIS

A weapon may be identified as to type and caliber from shell fragments found in the shell crater. Dimensions of the parts as well as of the complete shell, vary according to the caliber and type of shell. A typical shell is shown in Figure J-8.

a. Duds and Low-Order Bursts. The most logical means of identifying the caliber of a projectile is to inspect a dud of that caliber. However, since a dud may not always be available (or, if available, may be too dangerous to handle), a low-order burst is the next best means of identification. When the explosive filler is incompletely detonated, a low-order burst occurs and large shell fragments result. Such large pieces can be used to identify thread count, curvature, wall thickness, and other information not obtainable on smaller fragments. (See Figures J-1 and J-8.)

b. High-Order Burst. A high-order burst normally results in small, deformed fragments. These fragments are useless for identification purposes unless they include a section of either the rotating band or the rotating band seat. Fragments of either of these sections positively identify the shell, since each shell has its own distinctive rotating band markings.

c. Rotating Bands and Band Seats. (See Figure J-9.) A shell may be identified as to caliber, type and nation of origin from the following:

- Pattern or rifling imprints.
- Width, number, and size of rotating bands.
- Dimensions and pattern of keying or knurling on the band seat.
- Dimensions and pattern of keying and knurling impressed on the rotating band.

Note: Spin-stabilized artillery projectiles require a rotating band and band seat.

d. Tail Fins. A mortar may be identified from the tail tin (Figures J-9 and J-10). Often, tail fins are found in the fuze tunnel of the crater. A mortar that is not fin-stabilized may be identified from the pieces of the projectile on which the rifling is imprinted.

e. Fuzes. Since the same type of fuze may be used with several different calibers or types of projectiles, it is impossible to establish the type and caliber of a weapon by this means.

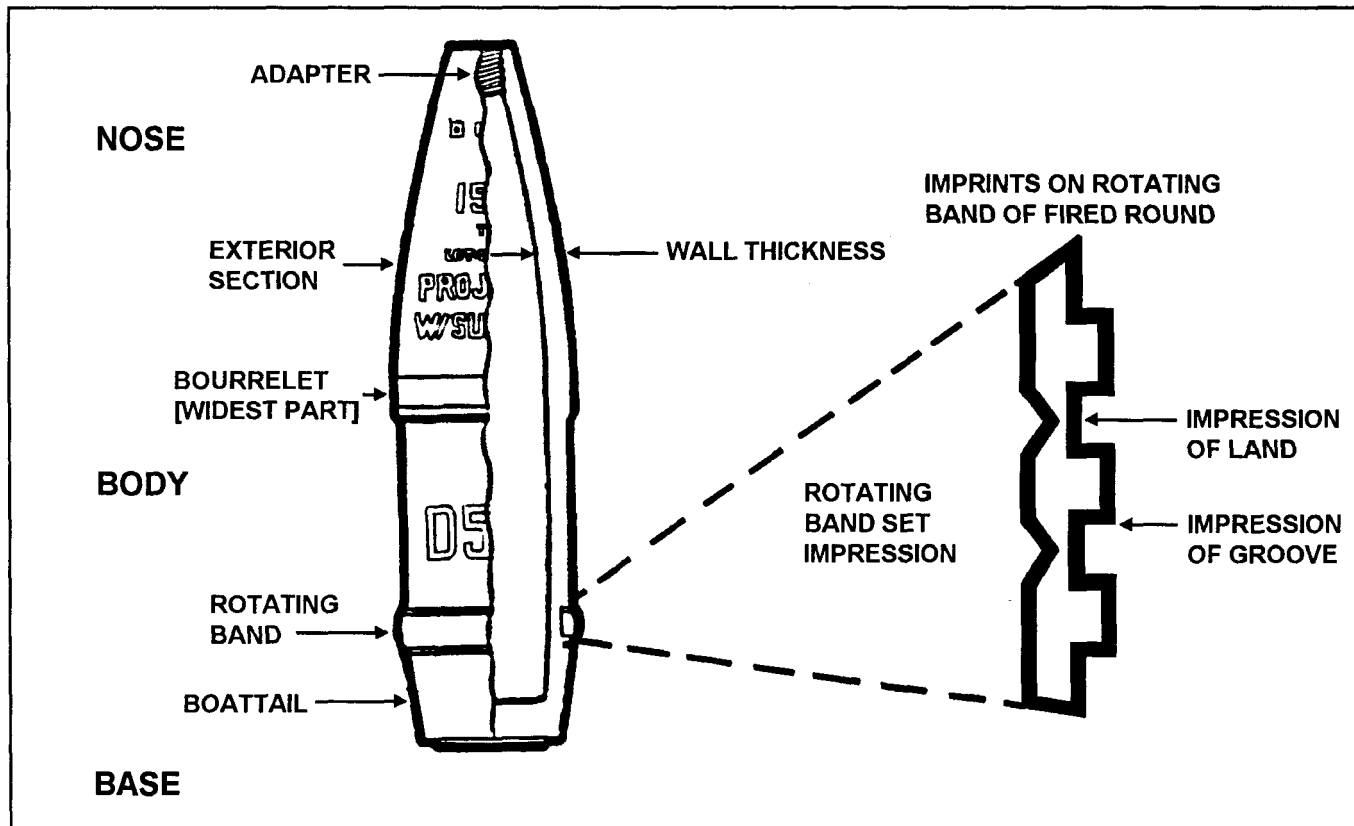

Figure J-8. Typical shell

Note: With the exception of the rotating bands and band seats or the tail fins, different types of shells may be identical in one dimension (such as wall thickness) but seldom will be alike in two or more dimensions. Therefore, it is necessary to obtain two or more measurements to make a positive identification.

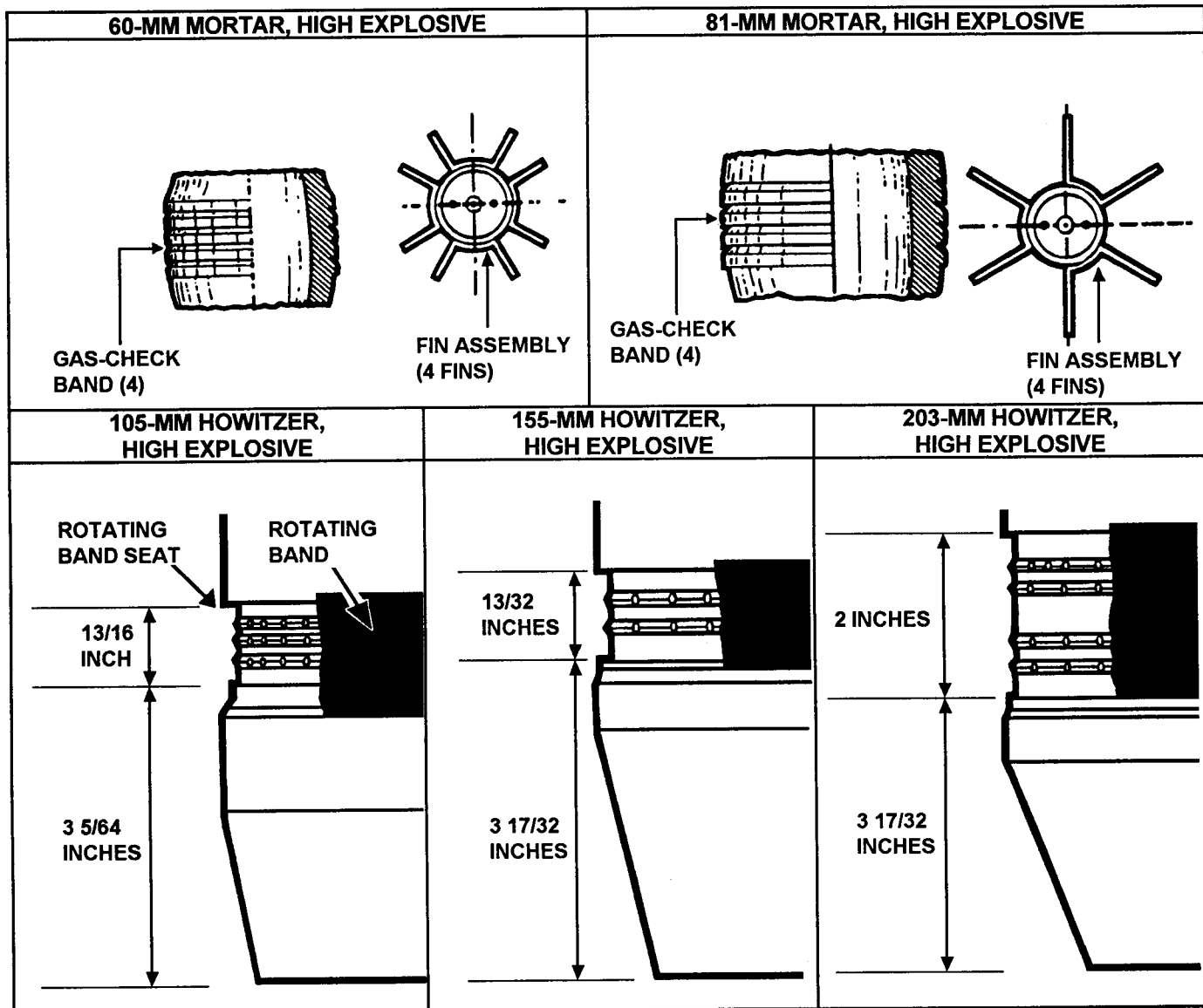

Figure J-9. Shell fragment and tail identification, US ammunition

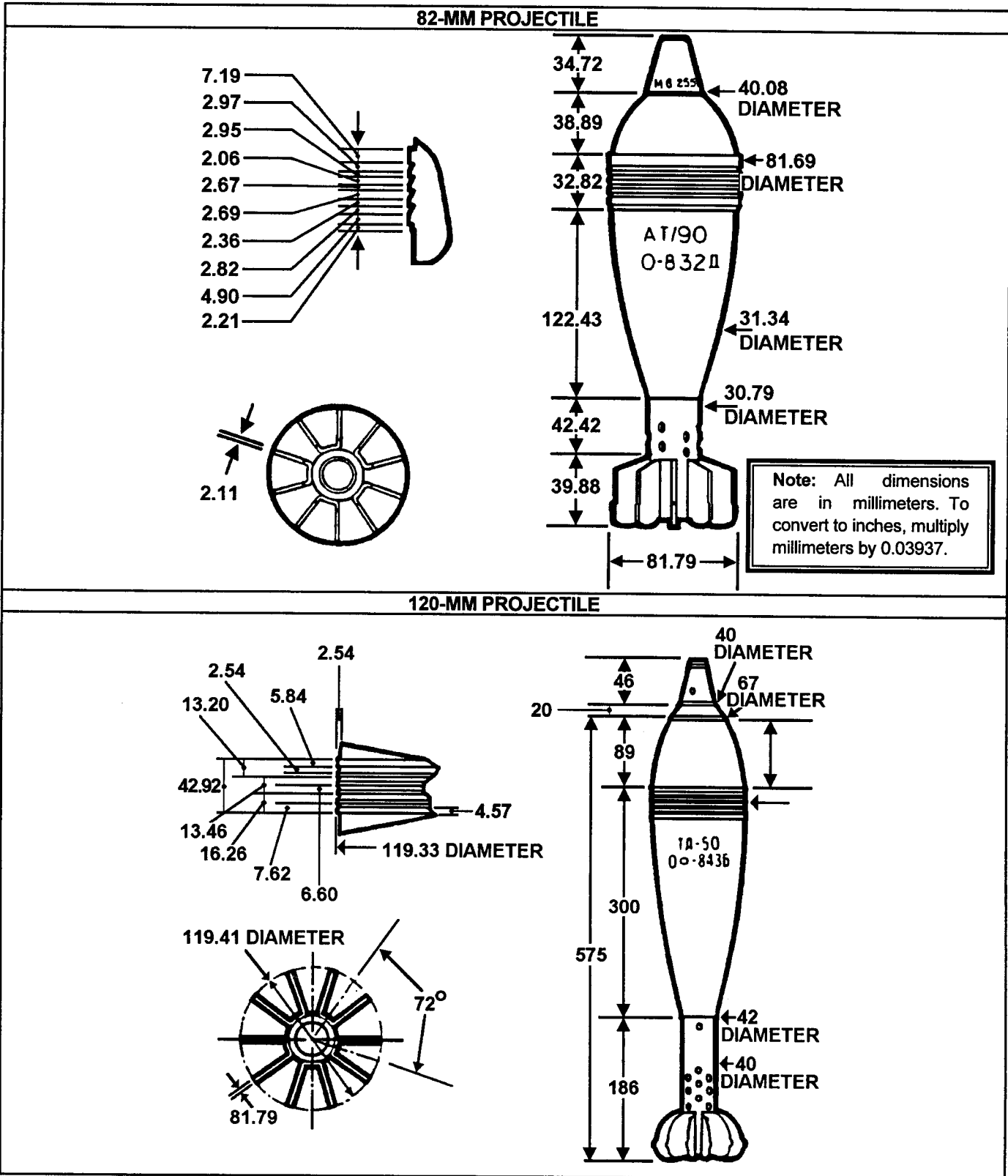

Figure J-10. Other nations' ammunition

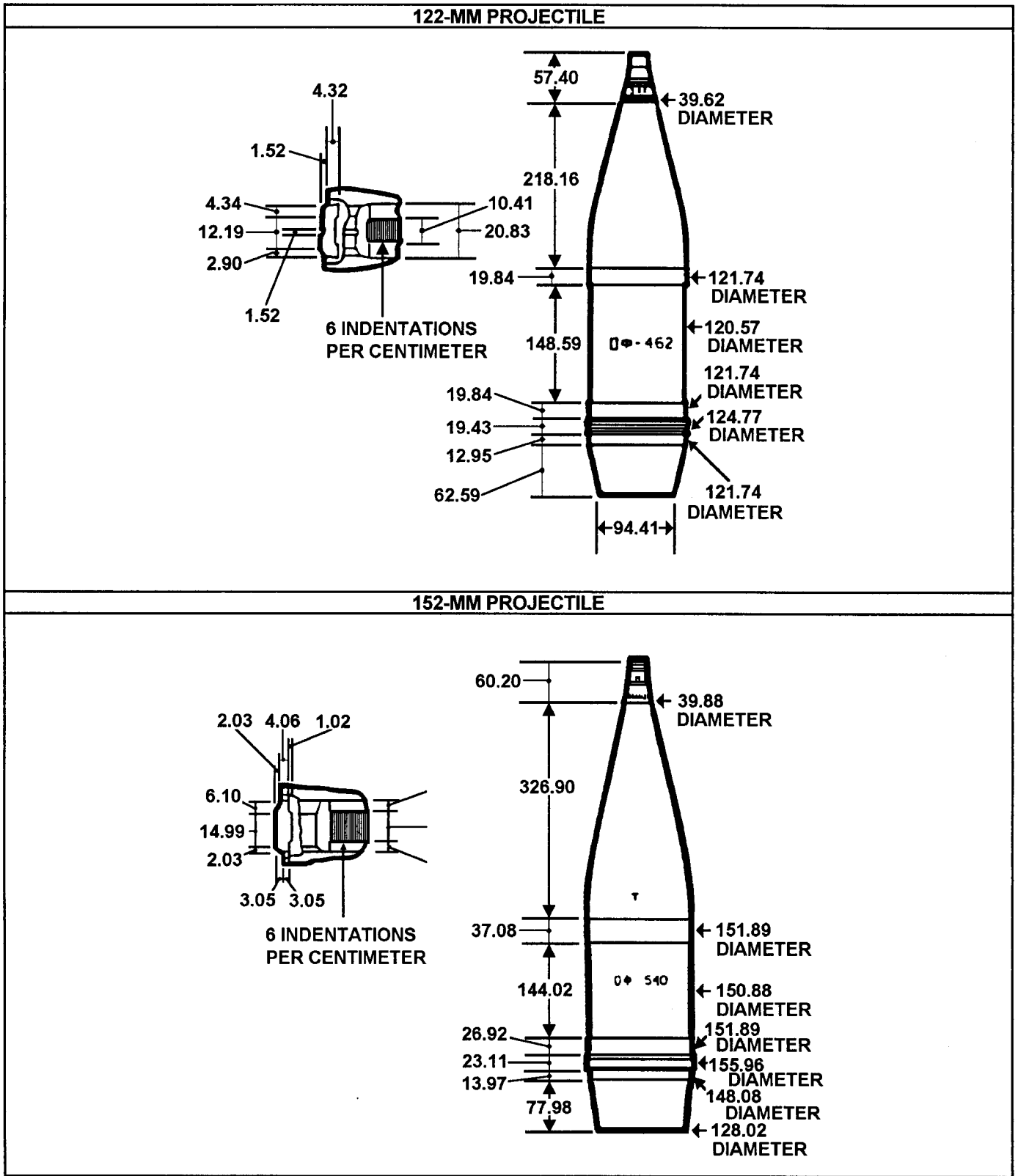

Figure J-10. Other nations' ammunition (continued)

J-14. SHELLING REPORTS

The division artillery (div arty) is responsible for counterfire. Therefore, bombing reports (BOMBREPs), shelling reports (SHELREPs), and mortar reports (MORTREPs) should be forwarded as quickly as possible to the div arty tactical operations center (TOC) through either fire direction or fire support channels. If a report is received by a DS battalion and that battalion decides to attack, the report of action taken and a damage assessment, if available, should be forwarded to the div arty TOC when the action is completed.

a. Contents. To provide a standard method of rendering reports on enemy bombing, shelling, and mortaring within the NATO forces operating on land, and the United States armed forces and certain other NATO armed forces, have concurred in the provisions of STANAG 2008. Refer to STANAG 2103 as implemented in FM 3-100 (in conjunction with STANAG 2008), for guidance in reporting the type of attack.

b. Artillery Counterfire Information Form. The information obtained from a crater should be forwarded by the most rapid means available—the ATI:SHR followed up with DA Form 2185-R (Artillery Counterfire Information) (ACIF) (Figure J-11). Regardless of how little information has been obtained, do not hesitate to forward it. Fragmentary or incomplete information (a radio or telephone report) is often valuable in supplementing or confirming existing information. This radio or telephone report may be followed by a written report (DA Form 2185-R).

Note: A reproducible copy of DA Form 2185-R is located at the back of this manual.

c. Fragments. Any usable fragments obtained from crater analysis should be tagged (shoe tag) and sent to the battalion S2. As a minimum, the tag should indicate the following:

- The location of the hostile weapon.
- The direction to the hostile weapon.
- The date-time group of the shelling.
- Mortar, artillery, or rocket, if known.

EXAMPLE

The information in the following situation is illustrated on the completed DA Form 2185-R (Figure J-11). You are the executive officer of Battery A, 1st Battalion, 3d Field Artillery. Your cell sign is A3F22, which is located at grid 39288415. At 0545 hours, the enemy shelled your position for 2 minutes with a total of eight rounds of HE shells. The tempo and pattern of bursts suggest an enemy four-gun battery. Your battery commander believes that the enemy's intent was harassment. Your SHELREP team determined the direction to the enemy battery to be 4,810 mils. They also located a fragment which included a portion of the rotating band seat. The shell has been identified as an enemy 122-mm howitzer projectile.

The four blanks above SECTION I of DA Form 2185-R are not completed by the SHELREP team. They are filled in by the receiving agency, for example, the battalion S2 section.

Items B and K or SECTION I are encoded for security reasons. The current call sign or code name for the unit is used in item A. Item B is not applicable when this form is used for crater analysis.

SECTIONS II and III are completed by the target production section of the div arty TOC.

The information contained in a SHELREP is forwarded by the DS artillery S2 to the targeting cell at div arty. He plots (on a SHELREP overlay) the location of the crater and a line representing the direction measured to the weapon. He compares the information with that received from other sources and attempts to locate enemy weapons from the intersections of direction lines to weapons of the same caliber.

| ARTILLERY COUNTERFIRE INFORMATION (For use of this form, see FM 6-121; the proponent agency is TRADOC.) | | | | | | | | | | |
|--|---|--|---|---|---|--|---|--|---|--------------------------------|
| RECEIVED BY | | | FROM | | TIME | | NUMBER | | | |
| SECTION I - BOMREP, SHELREP, MORTREP, OR ROCKREP (Cross out items not applicable.) | | | | | | | | | | |
| UNIT OF ORIGIN (Current call sign address group or code name) | POSITION OF OBSERVER (Encode if HQ or important OP or if Column F gives info on location) | DIRECTION (Grid bearing of FLASH, SOUND, or GROOVE of SHELL [state which] in mils unless otherwise stated). (Omit for aircraft) | TIME FROM | TIME TO | AREA BOMBED, SHELLED, OR MORTARED (Grid ref [in clear] or grid bearing to impact in mils and distance from observer in meters [encoded]) (Dimension of the area in meters) by (the radius) or (length and width) | NUMBER AND NATURE OF GUNS (Mortars, rocket launchers, aircraft, or other methods of delivery) | NATURE OF FIRE (Adjustment, fire for effect, or harassing) (May be omitted for aircraft) | NUMBER, TYPE, AND CALIBER (State whether measured or assumed) OF SHELLS, ROCKETS (or MISSILES), AND BOMBS | TIME OF FLASH-TO-BANG (Omit for aircraft) | DAMAGE (Encode if required) |
| F22 <small>A</small> | NA <small>B</small> | 4810H <small>C</small> | 0545 <small>D</small> | 0547 <small>E</small> | 39268415 <small>F</small> | 4 ARTY <small>G</small> | H <small>H</small> | 8 HE 122 <small>I</small> | NA <small>J</small> | NA <small>K</small> |
| SECTION II - LOCATION REPORT | | | | | | | SECTION III - COUNTERFIRE ACTION | | | |
| REMARKS | SERIAL NUMBER (Each location that is produced by a locating unit is given a serial number) | TARGET NUMBER (If the weapon or activity has previously been given a target number, it will be entered here) | POSITION OF TARGET (The grid reference or grid bearing and distance of the located weapon or activity) | ACCURACY (The accuracy to which the weapon was located. CEP in meters and the means of location if possible) | TIME OF LOCATION (Actual time the location was made) | TARGET DESCRIPTION (Dimensions if possible): 1. Radius of target 2. Target length and width in meters | TIME FIRED (Against hostile target) | FIRED BY | NUMBER OF ROUNDS, TYPE OF FUZE, AND PROJECTILES | |
| <small>L</small> | <small>M</small> | <small>N</small> | <small>P</small> | <small>Q</small> | <small>R</small> | <small>S</small> | <small>T</small> | <small>U</small> | <small>V</small> | |

DA FORM 2185-R, 1 APR 90 (Conforms with STANAG 2008) Edition of 1 May 78 is obsolete.

Figure J-11. Completed DA Form 2185-R

APPENDIX K
MINIMUM QUADRANT ELEVATION RAPID FIRE TABLES

K-1. DESCRIPTION OF THE TABLES

a. These rapid fire tables include all the elements of the platoon leader's (XO's) minimum QE discussed in Chapter 6 except Angle 1 (site to crest). Separate tables are included for each weapon-fuze-propellant combination. The value listed for elevation in all tables is the sum of the TFT elevation, two forks, Angle 2, and the comp site factor for the vertical angle of site for +300 mils angle of site. The tables are valid only when the sum of Angle 1 and Angle 2 (appropriate vertical clearance) is 300 mils or less. If the sum is greater than 300 mils, you must compute the data as shown in Chapter 6. To expedite the process of determining angle 2, Table K-1 is provided.

Table K-1. **Angle 2 Quick Reference Guide**

| RANGE | ANGLE 2 |
|-----------|---------|
| 100 | 51 |
| 200 | 26 |
| 300 | 17 |
| 400 | 13 |
| 500 | 11 |
| 600 | 9 |
| 700 | 8 |
| 800 | 7 |
| 900-1000 | 6 |
| 1100-1200 | 5 |
| 1300-1600 | 4 |
| 1700-2500 | 3 |
| 2600-5000 | 2 |
| 5100- | 1 |

Note: Angle 2 = $\frac{5 \text{ meters}}{\text{PIECE-TO-CREST RANGE (in thousands)}}$

Five meters is the appropriate vertical clearance for firing fuzes other than armed VT.

b. The time listed in the armed VT fuze tables (M513, M514, M728, M732) includes the TFT time of flight plus 5.5 seconds expressed to the next higher whole second (minimum safe time) for each listed range. When the time set on the VT fuze is equal to or greater than the time listed in the table, the platoon leader's (XO's) minimum quadrant elevation for fuzes other than VT is used (unarmed VT).

Note: All M557, M564 tables are used for unarmed VT fuzes. Use information in the EL column of the VT tables only when firing less than min safe time.

K-2. USE OF THE RAPID FIRE TABLES

- a. Add Angle 1 and Angle 2. Sum must be 300 mils or less to use rapid firing tables (Tables K-2 through K-16).
- b. Enter the table at the piece-to-crest range and determine the elevation for the appropriate charge(s).
- c. Add Angle 1 and elevation obtained from appropriate table. The sum is the minimum quadrant elevation.
- d. There are restrictions on the use of the VT fuze when firing certain charges on some weapon systems. These areas are boxed on the tables by shading. For the specific restrictions, refer to the weapon operator's manual and/or TM 43-0001-28.
- e. The TI column in the rapid fire tables is the same as minimum safe time (MST).
- f. Fuze M732 has the same performance characteristics as fuze M728.

EXAMPLE

Gun #1 (155-mm howitzer M109A3) range to the crest is 900 meters. Angle of site reported by the chief of section is +80. Determine the minimum quadrant elevation for charge 5 white bag, fuze M564 for Gun #1.

SOLUTION

- Angle of site to crest (Angle 1) +80
- Add Angles 1 and Angle 2 +6
- Sum is 300 mils or less. Use rapid fire tables. 86
- Using Tables K-8 through K-16, enter the appropriate table with the appropriate fuze and propellant type. Extract elevation at the appropriate charge and piece-to-crest range. 40
- Add Angle 1 to the minimum elevation. +80
- Gun #1 minimum QE 120

Note: Always compute the XO's minimum QE for all howitzers, and select the largest value as the platoon leader's or battery XO's minimum QE.

Table K-2. Rapid fire table for M101A1 (M557 and M564 fuzes)

| FUZE: M557, M564 | | | | PROPELLANT: M67 | | | |
|----------------------|-------|-------|-------|-----------------|-------|-------|-------|
| PIECE-TO-CREST RANGE | CHG 1 | CHG 2 | CHG 3 | CHG 4 | CHG 5 | CHG 6 | CHG 7 |
| 100 | 69 | 66 | 64 | 62 | 60 | 57 | 56 |
| 200 | 57 | 52 | 48 | 44 | 41 | 36 | 33 |
| 300 | 61 | 54 | 48 | 42 | 37 | 31 | 27 |
| 400 | 73 | 61 | 54 | 46 | 39 | 31 | 25 |
| 500 | 84 | 73 | 61 | 51 | 42 | 33 | 26 |
| 600 | 100 | 87 | 73 | 58 | 46 | 36 | 27 |
| 700 | 115 | 97 | 81 | 64 | 51 | 39 | 29 |
| 800 | 128 | 108 | 90 | 73 | 55 | 43 | 30 |
| 900 | 141 | 121 | 99 | 80 | 60 | 46 | 32 |
| 1,000 | 157 | 133 | 108 | 87 | 66 | 50 | 35 |
| 1,100 | 180 | 150 | 123 | 96 | 73 | 54 | 37 |
| 1,200 | 196 | 165 | 133 | 104 | 81 | 58 | 39 |
| 1,300 | 211 | 176 | 143 | 111 | 86 | 62 | 41 |
| 1,400 | 226 | 189 | 153 | 119 | 92 | 66 | 44 |
| 1,500 | 243 | 204 | 165 | 129 | 98 | 71 | 47 |
| 1,600 | 276 | 227 | 183 | 141 | 106 | 77 | 50 |
| 1,700 | 294 | 241 | 193 | 149 | 111 | 81 | 52 |
| 1,800 | 312 | 255 | 203 | 157 | 117 | 85 | 56 |
| 1,900 | 329 | 269 | 216 | 165 | 123 | 90 | 59 |
| 2,000 | 349 | 285 | 228 | 176 | 129 | 95 | 62 |
| 2,100 | 403 | 317 | 249 | 190 | 140 | 103 | 67 |
| 2,200 | 422 | 334 | 262 | 199 | 146 | 108 | 70 |
| 2,300 | 443 | 351 | 274 | 208 | 153 | 113 | 74 |
| 2,400 | 465 | 367 | 288 | 219 | 159 | 118 | 77 |
| 2,500 | 489 | 385 | 300 | 228 | 166 | 123 | 81 |
| 2,600 | 619 | 439 | 328 | 244 | 175 | 128 | 85 |
| 2,700 | 644 | 456 | 342 | 254 | 182 | 134 | 89 |
| 2,800 | 673 | 476 | 355 | 265 | 191 | 139 | 92 |
| 2,900 | 706 | 496 | 371 | 275 | 198 | 144 | 98 |
| 3,000 | 742 | 517 | 384 | 285 | 205 | 149 | 102 |
| 3,100 | 783 | 646 | 430 | 309 | 217 | 157 | 107 |
| 3,200 | | 670 | 447 | 319 | 224 | 162 | 112 |
| 3,300 | | 696 | 462 | 329 | 233 | 168 | 116 |
| 3,400 | | 725 | 479 | 342 | 240 | 173 | 120 |
| 3,500 | | 757 | 497 | 352 | 247 | 179 | 124 |
| 3,600 | | 795 | 584 | 384 | 262 | 187 | 130 |
| 3,700 | | | 603 | 396 | 269 | 193 | 134 |
| 3,800 | | | 626 | 409 | 279 | 199 | 139 |
| 3,900 | | | 647 | 421 | 287 | 207 | 143 |
| 4,000 | | | 671 | 435 | 295 | 212 | 148 |
| 4,500 | | | | 541 | 350 | 245 | 173 |
| 5,000 | | | | 709 | 413 | 284 | 201 |
| 5,500 | | | | | 490 | 324 | 229 |
| 6,000 | | | | | 593 | 370 | 259 |
| 6,500 | | | | | 757 | 423 | 292 |
| 7,000 | | | | | | 488 | 329 |
| 7,500 | | | | | | 569 | 369 |
| 8,000 | | | | | | 684 | 414 |
| 8,500 | | | | | | | 465 |
| 9,000 | | | | | | | 529 |
| 9,500 | | | | | | | 609 |
| 10,000 | | | | | | | 734 |

Table K-3. Rapid fire table for M101A1 (M513 fuze)

| FUZE: M513 | | | | | | | PROPELLANT: M67 | | | | | | | |
|----------------------|-------|------|-------|------|-------|------|-----------------|------|-------|------|-------|------|-------|------|
| PIECE-TO-CREST RANGE | CHG 1 | | CHG 2 | | CHG 3 | | CHG 4 | | CHG 5 | | CHG 6 | | CHG 7 | |
| | EL | TI | EL | TI | EL | TI | EL | TI | EL | TI | EL | TI | EL | TI |
| 100 | 69 | 8.0 | 66 | 8.0 | 64 | 8.0 | 62 | 8.0 | 60 | 8.0 | 57 | 8.0 | 56 | 8.0 |
| 200 | 57 | 8.0 | 52 | 8.0 | 48 | 8.0 | 44 | 8.0 | 41 | 8.0 | 36 | 8.0 | 33 | 8.0 |
| 300 | 61 | 8.0 | 54 | 8.0 | 48 | 8.0 | 42 | 8.0 | 37 | 8.0 | 31 | 8.0 | 27 | 8.0 |
| 400 | 264 | 8.0 | 61 | 8.0 | 54 | 8.0 | 46 | 8.0 | 39 | 8.0 | 31 | 8.0 | 25 | 8.0 |
| 500 | 236 | 9.0 | 225 | 8.0 | 213 | 8.0 | 51 | 8.0 | 42 | 8.0 | 33 | 8.0 | 26 | 8.0 |
| 600 | 227 | 9.0 | 214 | 9.0 | 200 | 9.0 | 184 | 8.0 | 46 | 8.0 | 36 | 8.0 | 27 | 8.0 |
| 700 | 224 | 10.0 | 206 | 9.0 | 190 | 9.0 | 173 | 9.0 | 160 | 8.0 | 39 | 8.0 | 29 | 8.0 |
| 800 | 223 | 10.0 | 203 | 10.0 | 185 | 9.0 | 168 | 9.0 | 150 | 9.0 | 138 | 8.0 | 30 | 8.0 |
| 900 | 226 | 11.0 | 206 | 10.0 | 184 | 10.0 | 165 | 9.0 | 145 | 9.0 | 131 | 9.0 | 32 | 8.0 |
| 1,000 | 233 | 11.0 | 209 | 11.0 | 184 | 10.0 | 163 | 10.0 | 142 | 9.0 | 126 | 9.0 | 111 | 8.0 |
| 1,100 | 250 | 12.0 | 220 | 11.0 | 193 | 11.0 | 166 | 10.0 | 143 | 10.0 | 124 | 9.0 | 107 | 8.0 |
| 1,200 | 259 | 12.0 | 228 | 12.0 | 196 | 11.0 | 167 | 11.0 | 144 | 10.0 | 121 | 9.0 | 102 | 9.0 |
| 1,300 | 270 | 13.0 | 235 | 12.0 | 202 | 12.0 | 170 | 11.0 | 145 | 10.0 | 121 | 10.0 | 100 | 9.0 |
| 1,400 | 281 | 14.0 | 244 | 13.0 | 208 | 12.0 | 174 | 11.0 | 147 | 11.0 | 121 | 10.0 | 99 | 9.0 |
| 1,500 | 294 | 14.0 | 255 | 13.0 | 216 | 13.0 | 180 | 12.0 | 149 | 11.0 | 122 | 10.0 | 98 | 10.0 |
| 1,600 | 323 | 15.0 | 274 | 14.0 | 230 | 13.0 | 188 | 12.0 | 153 | 11.0 | 124 | 11.0 | 97 | 10.0 |
| 1,700 | 339 | 15.0 | 286 | 14.0 | 238 | 14.0 | 194 | 13.0 | 156 | 12.0 | 126 | 11.0 | 97 | 10.0 |
| 1,800 | 355 | 16.0 | 298 | 15.0 | 246 | 14.0 | 200 | 13.0 | 160 | 12.0 | 128 | 11.0 | 99 | 10.0 |
| 1,900 | 369 | 17.0 | 309 | 16.0 | 256 | 15.0 | 205 | 14.0 | 163 | 13.0 | 130 | 12.0 | 99 | 11.0 |
| 2,000 | 387 | 17.0 | 323 | 16.0 | 266 | 15.0 | 214 | 14.0 | 167 | 13.0 | 133 | 12.0 | 100 | 11.0 |
| 2,100 | 439 | 18.0 | 353 | 17.0 | 285 | 16.0 | 226 | 14.0 | 176 | 13.0 | 139 | 12.0 | 103 | 11.0 |
| 2,200 | 457 | 19.0 | 369 | 17.0 | 297 | 16.0 | 234 | 15.0 | 181 | 14.0 | 143 | 13.0 | 105 | 11.0 |
| 2,300 | 476 | 19.0 | 384 | 18.0 | 307 | 17.0 | 241 | 15.0 | 186 | 14.0 | 146 | 13.0 | 107 | 12.0 |
| 2,400 | 496 | 20.0 | 398 | 19.0 | 319 | 17.0 | 250 | 16.0 | 190 | 14.0 | 149 | 13.0 | 108 | 12.0 |
| 2,500 | 519 | 21.0 | 415 | 19.0 | 330 | 18.0 | 258 | 16.0 | 196 | 15.0 | 153 | 14.0 | 111 | 12.0 |
| 2,600 | 649 | 21.0 | 469 | 20.0 | 358 | 18.0 | 274 | 17.0 | 205 | 15.0 | 158 | 14.0 | 115 | 13.0 |
| 2,700 | 673 | 22.0 | 485 | 20.0 | 371 | 19.0 | 283 | 17.0 | 213 | 16.0 | 163 | 14.0 | 118 | 13.0 |
| 2,800 | 701 | 23.0 | 504 | 21.0 | 383 | 19.0 | 293 | 18.0 | 219 | 16.0 | 167 | 15.0 | 120 | 13.0 |
| 2,900 | 733 | 24.0 | 523 | 22.0 | 398 | 20.0 | 302 | 18.0 | 225 | 16.0 | 171 | 15.0 | 125 | 14.0 |
| 3,000 | 768 | 25.0 | 543 | 23.0 | 410 | 21.0 | 311 | 19.0 | 231 | 17.0 | 175 | 15.0 | 128 | 14.0 |
| 3,100 | | | 671 | 23.0 | 455 | 21.0 | 334 | 19.0 | 242 | 17.0 | 182 | 16.0 | 132 | 14.0 |
| 3,200 | | | 694 | 24.0 | 471 | 22.0 | 343 | 20.0 | 248 | 18.0 | 186 | 16.0 | 136 | 15.0 |
| 3,300 | | | 719 | 25.0 | 485 | 22.0 | 352 | 20.0 | 256 | 18.0 | 191 | 16.0 | 139 | 15.0 |
| 3,400 | | | 747 | 26.0 | 501 | 23.0 | 364 | 21.0 | 262 | 18.0 | 195 | 17.0 | 142 | 15.0 |
| 3,500 | | | 779 | 27.0 | 519 | 24.0 | 374 | 21.0 | 269 | 19.0 | 201 | 17.0 | 146 | 16.0 |
| 3,600 | | | | | 605 | 24.0 | 405 | 22.0 | 283 | 19.0 | 208 | 18.0 | 151 | 16.0 |
| 3,700 | | | | | 624 | 25.0 | 417 | 22.0 | 290 | 20.0 | 214 | 18.0 | 155 | 16.0 |
| 3,800 | | | | | 646 | 26.0 | 429 | 23.0 | 299 | 20.0 | 219 | 18.0 | 159 | 16.0 |
| 3,900 | | | | | 666 | 27.0 | 440 | 23.0 | 306 | 20.0 | 226 | 19.0 | 162 | 17.0 |
| 4,000 | | | | | 690 | 27.0 | 454 | 24.0 | 314 | 21.0 | 231 | 19.0 | 167 | 17.0 |
| 4,500 | | | | | | | 558 | 27.0 | 367 | 23.0 | 262 | 21.0 | 190 | 19.0 |
| 5,000 | | | | | | | 724 | 30.0 | 428 | 26.0 | 299 | 23.0 | 216 | 21.0 |
| 5,500 | | | | | | | | | 504 | 28.0 | 338 | 25.0 | 243 | 22.0 |
| 6,000 | | | | | | | | | 606 | 31.0 | 383 | 27.0 | 272 | 24.0 |
| 6,500 | | | | | | | | | 769 | 35.0 | 435 | 29.0 | 304 | 26.0 |
| 7,000 | | | | | | | | | | | 499 | 32.0 | 340 | 28.0 |
| 7,500 | | | | | | | | | | | 579 | 35.0 | 379 | 30.0 |
| 8,000 | | | | | | | | | | | 694 | 38.0 | 424 | 32.0 |
| 8,500 | | | | | | | | | | | | | 474 | 35.0 |
| 9,000 | | | | | | | | | | | | | 538 | 37.0 |
| 9,500 | | | | | | | | | | | | | 617 | 40.0 |
| 10,000 | | | | | | | | | | | | | 742 | 43.0 |

Table K-4. Rapid fire table for M101A1 (M728 and M732 fuzes)

| FUZE: M728, M732 | | | | | | | PROPELLANT: M67 | | | | | | | |
|----------------------|-------|------|-------|------|-------|------|-----------------|------|-------|------|-------|------|-------|------|
| PIECE-TO-CREST RANGE | CHG 1 | | CHG 2 | | CHG 3 | | CHG 4 | | CHG 5 | | CHG 6 | | CHG 7 | |
| | EL | TI | EL | TI | EL | TI | EL | TI | EL | TI | EL | TI | EL | TI |
| 100 | 69 | 8.0 | 66 | 8.0 | 64 | 8.0 | 62 | 8.0 | 60 | 8.0 | 57 | 8.0 | 56 | 8.0 |
| 200 | 57 | 8.0 | 52 | 8.0 | 48 | 8.0 | 44 | 8.0 | 41 | 8.0 | 36 | 8.0 | 33 | 8.0 |
| 300 | 60 | 8.0 | 54 | 8.0 | 48 | 8.0 | 42 | 8.0 | 37 | 8.0 | 31 | 8.0 | 27 | 8.0 |
| 400 | 188 | 8.0 | 61 | 8.0 | 54 | 8.0 | 46 | 8.0 | 39 | 8.0 | 31 | 8.0 | 25 | 8.0 |
| 500 | 175 | 9.0 | 164 | 8.0 | 152 | 8.0 | 51 | 8.0 | 42 | 8.0 | 33 | 8.0 | 26 | 8.0 |
| 600 | 171 | 9.0 | 163 | 9.0 | 149 | 9.0 | 133 | 8.0 | 46 | 8.0 | 36 | 8.0 | 27 | 8.0 |
| 700 | 180 | 10.0 | 162 | 9.0 | 146 | 9.0 | 129 | 9.0 | 116 | 8.0 | 39 | 8.0 | 29 | 8.0 |
| 800 | 185 | 10.0 | 165 | 10.0 | 147 | 9.0 | 130 | 9.0 | 112 | 9.0 | 100 | 8.0 | 30 | 8.0 |
| 900 | 193 | 11.0 | 173 | 10.0 | 151 | 10.0 | 132 | 9.0 | 112 | 9.0 | 98 | 9.0 | 32 | 8.0 |
| 1,000 | 203 | 11.0 | 179 | 11.0 | 154 | 10.0 | 133 | 10.0 | 112 | 9.0 | 96 | 9.0 | 81 | 8.0 |
| 1,100 | 222 | 12.0 | 192 | 11.0 | 165 | 11.0 | 138 | 10.0 | 115 | 10.0 | 96 | 9.0 | 79 | 8.0 |
| 1,200 | 234 | 12.0 | 203 | 12.0 | 171 | 11.0 | 142 | 11.0 | 119 | 10.0 | 96 | 9.0 | 77 | 9.0 |
| 1,300 | 246 | 13.0 | 211 | 12.0 | 178 | 12.0 | 146 | 11.0 | 121 | 10.0 | 97 | 10.0 | 76 | 9.0 |
| 1,400 | 259 | 14.0 | 222 | 13.0 | 186 | 12.0 | 155 | 11.0 | 125 | 11.0 | 99 | 10.0 | 77 | 9.0 |
| 1,500 | 274 | 14.0 | 235 | 13.0 | 196 | 13.0 | 160 | 12.0 | 129 | 11.0 | 102 | 10.0 | 78 | 10.0 |
| 1,600 | 304 | 15.0 | 255 | 14.0 | 211 | 13.0 | 169 | 12.0 | 134 | 11.0 | 105 | 11.0 | 78 | 10.0 |
| 1,700 | 321 | 15.0 | 268 | 14.0 | 220 | 14.0 | 176 | 13.0 | 138 | 12.0 | 108 | 11.0 | 79 | 10.0 |
| 1,800 | 338 | 16.0 | 281 | 15.0 | 229 | 14.0 | 183 | 13.0 | 143 | 12.0 | 111 | 11.0 | 82 | 10.0 |
| 1,900 | 353 | 17.0 | 293 | 16.0 | 240 | 15.0 | 189 | 14.0 | 147 | 13.0 | 114 | 12.0 | 83 | 11.0 |
| 2,000 | 372 | 17.0 | 308 | 16.0 | 251 | 15.0 | 199 | 14.0 | 152 | 13.0 | 118 | 12.0 | 85 | 11.0 |
| 2,100 | 424 | 18.0 | 338 | 17.0 | 270 | 16.0 | 211 | 14.0 | 161 | 13.0 | 124 | 12.0 | 88 | 11.0 |
| 2,200 | 443 | 19.0 | 355 | 17.0 | 283 | 16.0 | 220 | 15.0 | 167 | 14.0 | 129 | 13.0 | 91 | 11.0 |
| 2,300 | 463 | 19.0 | 371 | 18.0 | 294 | 17.0 | 218 | 15.0 | 173 | 14.0 | 133 | 13.0 | 94 | 12.0 |
| 2,400 | 483 | 20.0 | 385 | 19.0 | 306 | 17.0 | 237 | 16.0 | 177 | 14.0 | 136 | 13.0 | 95 | 12.0 |
| 2,500 | 507 | 21.0 | 403 | 19.0 | 318 | 18.0 | 246 | 16.0 | 184 | 15.0 | 141 | 14.0 | 99 | 12.0 |
| 2,600 | 637 | 21.0 | 457 | 20.0 | 346 | 18.0 | 262 | 17.0 | 193 | 15.0 | 146 | 14.0 | 103 | 13.0 |
| 2,700 | 662 | 22.0 | 474 | 20.0 | 360 | 19.0 | 272 | 17.0 | 202 | 16.0 | 152 | 14.0 | 107 | 13.0 |
| 2,800 | 690 | 23.0 | 493 | 21.0 | 372 | 19.0 | 282 | 18.0 | 208 | 16.0 | 156 | 15.0 | 109 | 13.0 |
| 2,900 | 722 | 24.0 | 512 | 22.0 | 387 | 20.0 | 291 | 18.0 | 214 | 16.0 | 160 | 15.0 | 114 | 14.0 |
| 3,000 | 758 | 25.0 | 533 | 23.0 | 400 | 21.0 | 301 | 19.0 | 221 | 17.0 | 165 | 15.0 | 118 | 14.0 |
| 3,100 | | | 662 | 23.0 | 446 | 21.0 | 325 | 19.0 | 223 | 17.0 | 173 | 16.0 | 123 | 14.0 |
| 3,200 | | | 685 | 24.0 | 462 | 22.0 | 334 | 20.0 | 239 | 18.0 | 177 | 16.0 | 127 | 15.0 |
| 3,300 | | | 710 | 25.0 | 476 | 22.0 | 343 | 20.0 | 247 | 18.0 | 182 | 16.0 | 130 | 15.0 |
| 3,400 | | | 738 | 26.0 | 492 | 23.0 | 355 | 21.0 | 253 | 18.0 | 186 | 17.0 | 133 | 15.0 |
| 3,500 | | | 770 | 27.0 | 510 | 24.0 | 365 | 21.0 | 260 | 19.0 | 192 | 17.0 | 137 | 16.0 |
| 3,600 | | | | | 596 | 24.0 | 396 | 22.0 | 274 | 19.0 | 199 | 18.0 | 142 | 16.0 |
| 3,700 | | | | | 616 | 25.0 | 409 | 22.0 | 282 | 20.0 | 206 | 18.0 | 147 | 16.0 |
| 3,800 | | | | | 638 | 26.0 | 421 | 23.0 | 291 | 20.0 | 211 | 18.0 | 154 | 16.0 |
| 3,900 | | | | | 658 | 27.0 | 432 | 23.0 | 298 | 20.0 | 218 | 19.0 | 154 | 17.0 |
| 4,000 | | | | | 683 | 27.0 | 446 | 24.0 | 306 | 21.0 | 223 | 19.0 | 159 | 17.0 |
| 4,500 | | | | | | | 551 | 27.0 | 360 | 23.0 | 255 | 21.0 | 183 | 19.0 |
| 5,000 | | | | | | | 718 | 30.0 | 422 | 26.0 | 293 | 23.0 | 210 | 21.0 |
| 5,500 | | | | | | | | | 498 | 28.0 | 332 | 25.0 | 237 | 22.0 |
| 6,000 | | | | | | | | | 601 | 31.0 | 378 | 27.0 | 267 | 24.0 |
| 6,500 | | | | | | | | | 764 | 35.0 | 430 | 29.0 | 299 | 26.0 |
| 7,000 | | | | | | | | | | | 495 | 32.0 | 336 | 28.0 |
| 7,500 | | | | | | | | | | | 575 | 35.0 | 375 | 30.0 |
| 8,000 | | | | | | | | | | | 690 | 38.0 | 420 | 32.0 |
| 8,500 | | | | | | | | | | | | | 471 | 35.0 |
| 9,000 | | | | | | | | | | | | | 535 | 37.0 |
| 9,500 | | | | | | | | | | | | | 614 | 40.0 |
| 10,000 | | | | | | | | | | | | | 739 | 43.0 |

Table K-5. Rapid fire table for M102/M119A1 (M557 and M564 fuzes)

| FUZE: M557, M564 | | | | PROPELLANT: M67 | | | |
|----------------------|-------|-------|-------|-----------------|-------|-------|-------|
| PIECE-TO-CREST RANGE | CHG 1 | CHG 2 | CHG 3 | CHG 4 | CHG 5 | CHG 6 | CHG 7 |
| 100 | 67 | 65 | 63 | 61 | 59 | 58 | 57 |
| 200 | 54 | 50 | 46 | 42 | 39 | 36 | 34 |
| 300 | 58 | 51 | 45 | 40 | 35 | 30 | 27 |
| 400 | 68 | 57 | 50 | 43 | 36 | 30 | 25 |
| 500 | 78 | 68 | 56 | 47 | 39 | 31 | 25 |
| 600 | 91 | 79 | 65 | 53 | 42 | 33 | 25 |
| 700 | 105 | 89 | 74 | 59 | 46 | 36 | 27 |
| 800 | 116 | 98 | 82 | 64 | 50 | 38 | 28 |
| 900 | 128 | 110 | 89 | 70 | 54 | 41 | 29 |
| 1,000 | 143 | 121 | 98 | 77 | 59 | 45 | 31 |
| 1,100 | 162 | 136 | 109 | 86 | 64 | 49 | 34 |
| 1,200 | 177 | 147 | 118 | 93 | 69 | 53 | 36 |
| 1,300 | 190 | 159 | 128 | 99 | 74 | 56 | 37 |
| 1,400 | 205 | 170 | 137 | 106 | 79 | 60 | 40 |
| 1,500 | 219 | 182 | 146 | 113 | 84 | 64 | 43 |
| 1,600 | 248 | 203 | 159 | 124 | 91 | 69 | 45 |
| 1,700 | 262 | 214 | 170 | 130 | 95 | 72 | 48 |
| 1,800 | 278 | 226 | 179 | 137 | 101 | 76 | 50 |
| 1,900 | 293 | 240 | 189 | 147 | 106 | 81 | 53 |
| 2,000 | 310 | 252 | 199 | 154 | 112 | 85 | 56 |
| 2,100 | 349 | 280 | 218 | 166 | 119 | 92 | 60 |
| 2,200 | 367 | 293 | 228 | 173 | 125 | 97 | 63 |
| 2,300 | 385 | 308 | 238 | 181 | 131 | 101 | 66 |
| 2,400 | 404 | 321 | 249 | 189 | 136 | 106 | 69 |
| 2,500 | 424 | 337 | 261 | 199 | 144 | 111 | 72 |
| 2,600 | 493 | 372 | 282 | 212 | 152 | 115 | 75 |
| 2,700 | 514 | 389 | 292 | 220 | 158 | 119 | 78 |
| 2,800 | 536 | 403 | 305 | 228 | 164 | 124 | 81 |
| 2,900 | 558 | 421 | 316 | 236 | 170 | 129 | 85 |
| 3,000 | 584 | 438 | 328 | 245 | 176 | 134 | 88 |
| 3,100 | | 503 | 359 | 263 | 185 | 142 | 94 |
| 3,200 | | 522 | 371 | 270 | 191 | 148 | 98 |
| 3,300 | | 541 | 385 | 281 | 198 | 155 | 102 |
| 3,400 | | 562 | 398 | 289 | 204 | 160 | 105 |
| 3,500 | | 583 | 413 | 300 | 210 | 165 | 109 |
| 3,600 | | | 457 | 322 | 221 | 171 | 113 |
| 3,700 | | | 472 | 331 | 227 | 176 | 117 |
| 3,800 | | | 488 | 340 | 234 | 181 | 123 |
| 3,900 | | | 502 | 352 | 240 | 187 | 128 |
| 4,000 | | | 519 | 362 | 247 | 192 | 132 |
| 4,500 | | | 690 | 436 | 290 | 227 | 157 |
| 5,000 | | | | 531 | 337 | 257 | 180 |
| 5,500 | | | | 670 | 387 | 298 | 208 |
| 6,000 | | | | | 450 | 334 | 234 |
| 6,500 | | | | | 527 | 389 | 270 |
| 7,000 | | | | | 633 | 430 | 299 |
| 7,500 | | | | | | 516 | 340 |
| 8,000 | | | | | | 565 | 375 |
| 8,500 | | | | | | | 431 |
| 9,000 | | | | | | | 471 |
| 9,500 | | | | | | | 561 |
| 10,000 | | | | | | | 609 |

Table K-6. Rapid fire table for M102/M119A1 (M513 fuze)

| FUZE: M513 | | | | | | | | PROPELLANT: M67 | | | | | | | |
|----------------------|-------|------|-------|------|-------|------|-------|-----------------|-------|------|-------|------|-------|------|--|
| PIECE-TO-CREST RANGE | CHG 1 | | CHG 2 | | CHG 3 | | CHG 4 | | CHG 5 | | CHG 6 | | CHG 7 | | |
| | EL | TI | EL | TI | EL | TI | EL | TI | EL | TI | EL | TI | EL | TI | |
| 100 | 67 | 8.0 | 65 | 8.0 | 63 | 8.0 | 61 | 8.0 | 59 | 8.0 | 58 | 8.0 | 57 | 8.0 | |
| 200 | 54 | 8.0 | 50 | 8.0 | 46 | 8.0 | 42 | 8.0 | 39 | 8.0 | 36 | 8.0 | 34 | 8.0 | |
| 300 | 58 | 8.0 | 51 | 8.0 | 45 | 8.0 | 40 | 8.0 | 35 | 8.0 | 30 | 8.0 | 27 | 8.0 | |
| 400 | 259 | 8.0 | 57 | 8.0 | 50 | 8.0 | 43 | 8.0 | 36 | 8.0 | 30 | 8.0 | 25 | 8.0 | |
| 500 | 230 | 8.0 | 220 | 8.0 | 208 | 8.0 | 47 | 8.0 | 39 | 8.0 | 31 | 8.0 | 25 | 8.0 | |
| 600 | 218 | 9.0 | 206 | 9.0 | 194 | 8.0 | 180 | 8.0 | 42 | 8.0 | 33 | 8.0 | 26 | 8.0 | |
| 700 | 214 | 9.0 | 198 | 9.0 | 183 | 9.0 | 168 | 9.0 | 155 | 8.0 | 36 | 8.0 | 28 | 8.0 | |
| 800 | 211 | 10.0 | 193 | 10.0 | 177 | 9.0 | 159 | 9.0 | 145 | 8.0 | 133 | 8.0 | 29 | 8.0 | |
| 900 | 213 | 10.0 | 195 | 10.0 | 174 | 10.0 | 155 | 9.0 | 139 | 9.0 | 126 | 8.0 | 30 | 8.0 | |
| 1,000 | 219 | 11.0 | 197 | 11.0 | 174 | 10.0 | 153 | 10.0 | 135 | 9.0 | 121 | 9.0 | 108 | 8.0 | |
| 1,100 | 232 | 11.0 | 206 | 11.0 | 179 | 11.0 | 156 | 10.0 | 134 | 9.0 | 119 | 9.0 | 103 | 8.0 | |
| 1,200 | 240 | 12.0 | 210 | 12.0 | 181 | 11.0 | 156 | 10.0 | 132 | 10.0 | 116 | 9.0 | 99 | 9.0 | |
| 1,300 | 249 | 13.0 | 218 | 12.0 | 187 | 11.0 | 158 | 11.0 | 133 | 10.0 | 115 | 10.0 | 96 | 9.0 | |
| 1,400 | 260 | 13.0 | 225 | 12.0 | 192 | 12.0 | 161 | 11.0 | 133 | 10.0 | 115 | 10.0 | 95 | 9.0 | |
| 1,500 | 270 | 14.0 | 233 | 13.0 | 197 | 12.0 | 164 | 12.0 | 135 | 11.0 | 115 | 10.0 | 94 | 9.0 | |
| 1,600 | 295 | 14.0 | 250 | 13.0 | 206 | 13.0 | 171 | 12.0 | 138 | 11.0 | 115 | 10.0 | 92 | 10.0 | |
| 1,700 | 307 | 15.0 | 259 | 14.0 | 215 | 13.0 | 175 | 12.0 | 140 | 11.0 | 116 | 11.0 | 92 | 10.0 | |
| 1,800 | 321 | 15.0 | 269 | 15.0 | 222 | 14.0 | 180 | 13.0 | 144 | 12.0 | 119 | 11.0 | 93 | 10.0 | |
| 1,900 | 333 | 16.0 | 280 | 15.0 | 229 | 14.0 | 187 | 13.0 | 146 | 12.0 | 120 | 11.0 | 93 | 10.0 | |
| 2,000 | 348 | 16.0 | 290 | 16.0 | 237 | 15.0 | 192 | 14.0 | 150 | 12.0 | 123 | 12.0 | 94 | 11.0 | |
| 2,100 | 385 | 17.0 | 316 | 16.0 | 254 | 15.0 | 202 | 14.0 | 155 | 13.0 | 127 | 12.0 | 96 | 11.0 | |
| 2,200 | 402 | 18.0 | 328 | 17.0 | 263 | 15.0 | 208 | 14.0 | 160 | 13.0 | 131 | 12.0 | 98 | 11.0 | |
| 2,300 | 418 | 18.0 | 341 | 17.0 | 271 | 16.0 | 214 | 15.0 | 164 | 14.0 | 134 | 13.0 | 99 | 11.0 | |
| 2,400 | 435 | 19.0 | 352 | 18.0 | 280 | 16.0 | 220 | 15.0 | 167 | 14.0 | 136 | 13.0 | 100 | 12.0 | |
| 2,500 | 454 | 20.0 | 367 | 18.0 | 291 | 17.0 | 229 | 16.0 | 174 | 14.0 | 140 | 13.0 | 102 | 12.0 | |
| 2,600 | 523 | 20.0 | 402 | 19.0 | 312 | 17.0 | 242 | 16.0 | 182 | 15.0 | 144 | 14.0 | 105 | 12.0 | |
| 2,700 | 543 | 21.0 | 418 | 19.0 | 321 | 18.0 | 249 | 16.0 | 187 | 15.0 | 148 | 14.0 | 107 | 13.0 | |
| 2,800 | 564 | 22.0 | 431 | 20.0 | 333 | 18.0 | 256 | 17.0 | 192 | 15.0 | 152 | 14.0 | 109 | 13.0 | |
| 2,900 | 585 | 22.0 | 448 | 21.0 | 343 | 19.0 | 263 | 17.0 | 197 | 16.0 | 156 | 15.0 | 112 | 13.0 | |
| 3,000 | 610 | 23.0 | 464 | 21.0 | 354 | 19.0 | 271 | 18.0 | 202 | 16.0 | 160 | 15.0 | 114 | 13.0 | |
| 3,100 | | | 528 | 22.0 | 384 | 20.0 | 288 | 18.0 | 210 | 16.0 | 167 | 15.0 | 119 | 14.0 | |
| 3,200 | | | 546 | 23.0 | 395 | 20.0 | 296 | 19.0 | 215 | 17.0 | 171 | 16.0 | 122 | 14.0 | |
| 3,300 | | | 564 | 23.0 | 408 | 21.0 | 304 | 19.0 | 221 | 17.0 | 177 | 16.0 | 125 | 14.0 | |
| 3,400 | | | 584 | 24.0 | 420 | 22.0 | 312 | 20.0 | 226 | 18.0 | 182 | 16.0 | 127 | 15.0 | |
| 3,500 | | | 605 | 25.0 | 435 | 22.0 | 322 | 20.0 | 232 | 18.0 | 187 | 17.0 | 131 | 15.0 | |
| 3,600 | | | 793 | 25.0 | 478 | 23.0 | 343 | 20.0 | 242 | 18.0 | 191 | 17.0 | 134 | 15.0 | |
| 3,700 | | | | | 493 | 23.0 | 352 | 21.0 | 248 | 19.0 | 197 | 17.0 | 138 | 16.0 | |
| 3,800 | | | | | 508 | 24.0 | 360 | 21.0 | 254 | 19.0 | 201 | 18.0 | 143 | 16.0 | |
| 3,900 | | | | | 521 | 25.0 | 371 | 22.0 | 259 | 20.0 | 206 | 18.0 | 147 | 16.0 | |
| 4,000 | | | | | 538 | 25.0 | 381 | 22.0 | 266 | 20.0 | 211 | 19.0 | 151 | 17.0 | |
| 4,500 | | | | | 707 | 29.0 | 453 | 25.0 | 307 | 22.0 | 243 | 20.0 | 174 | 18.0 | |
| 5,000 | | | | | | | 546 | 28.0 | 352 | 24.0 | 271 | 22.0 | 195 | 20.0 | |
| 5,500 | | | | | | | 684 | 31.0 | 401 | 26.0 | 312 | 24.0 | 222 | 22.0 | |
| 6,000 | | | | | | | | | 463 | 29.0 | 346 | 26.0 | 247 | 24.0 | |
| 6,500 | | | | | | | | | 539 | 31.0 | 401 | 28.0 | 282 | 25.0 | |
| 7,000 | | | | | | | | | 644 | 34.0 | 440 | 31.0 | 310 | 27.0 | |
| 7,500 | | | | | | | | | | | 526 | 33.0 | 350 | 29.0 | |
| 8,000 | | | | | | | | | | | 575 | 36.0 | 385 | 32.0 | |
| 8,500 | | | | | | | | | | | | | 440 | 34.0 | |
| 9,000 | | | | | | | | | | | | | 480 | 36.0 | |
| 9,500 | | | | | | | | | | | | | 569 | 39.0 | |
| 10,000 | | | | | | | | | | | | | 617 | 42.0 | |

Table K-7. Rapid fire table for M102/M119A1 (M728 and M732 fuzes)

| FUZE: M728, M732 | | | | | | | | PROPELLANT: M67 | | | | | | | |
|----------------------|-------|------|-------|------|-------|------|-------|-----------------|-------|------|-------|------|-------|------|--|
| PIECE-TO-CREST RANGE | CHG 1 | | CHG 2 | | CHG 3 | | CHG 4 | | CHG 5 | | CHG 6 | | CHG 7 | | |
| | EL | TI | EL | TI | EL | TI | EL | TI | EL | TI | EL | TI | EL | TI | |
| 100 | 67 | 8.0 | 65 | 8.0 | 63 | 8.0 | 61 | 8.0 | 59 | 8.0 | 58 | 8.0 | 57 | 8.0 | |
| 200 | 54 | 8.0 | 50 | 8.0 | 46 | 8.0 | 42 | 8.0 | 39 | 8.0 | 36 | 8.0 | 34 | 8.0 | |
| 300 | 58 | 8.0 | 51 | 8.0 | 45 | 8.0 | 40 | 8.0 | 35 | 8.0 | 30 | 8.0 | 27 | 8.0 | |
| 400 | 183 | 8.0 | 57 | 8.0 | 50 | 8.0 | 43 | 8.0 | 36 | 8.0 | 30 | 8.0 | 25 | 8.0 | |
| 500 | 169 | 8.0 | 159 | 8.0 | 147 | 8.0 | 47 | 8.0 | 39 | 8.0 | 31 | 8.0 | 25 | 8.0 | |
| 600 | 167 | 9.0 | 155 | 9.0 | 143 | 8.0 | 129 | 8.0 | 42 | 8.0 | 33 | 8.0 | 25 | 8.0 | |
| 700 | 170 | 9.0 | 154 | 9.0 | 139 | 9.0 | 124 | 9.0 | 111 | 8.0 | 36 | 8.0 | 27 | 8.0 | |
| 800 | 173 | 10.0 | 155 | 10.0 | 139 | 9.0 | 121 | 9.0 | 107 | 8.0 | 95 | 8.0 | 28 | 8.0 | |
| 900 | 180 | 10.0 | 162 | 10.0 | 141 | 10.0 | 122 | 9.0 | 106 | 9.0 | 93 | 8.0 | 29 | 8.0 | |
| 1,000 | 189 | 11.0 | 167 | 11.0 | 144 | 10.0 | 123 | 10.0 | 105 | 9.0 | 91 | 9.0 | 78 | 8.0 | |
| 1,100 | 204 | 11.0 | 178 | 11.0 | 151 | 11.0 | 128 | 10.0 | 106 | 9.0 | 91 | 9.0 | 75 | 8.0 | |
| 1,200 | 215 | 12.0 | 185 | 12.0 | 156 | 11.0 | 131 | 10.0 | 107 | 10.0 | 91 | 9.0 | 74 | 9.0 | |
| 1,300 | 225 | 13.0 | 194 | 12.0 | 163 | 11.0 | 134 | 11.0 | 109 | 10.0 | 91 | 10.0 | 74 | 9.0 | |
| 1,400 | 238 | 13.0 | 203 | 12.0 | 170 | 12.0 | 139 | 11.0 | 111 | 10.0 | 93 | 10.0 | 74 | 9.0 | |
| 1,500 | 250 | 14.0 | 213 | 13.0 | 177 | 12.0 | 144 | 12.0 | 115 | 11.0 | 95 | 10.0 | 74 | 9.0 | |
| 1,600 | 276 | 14.0 | 231 | 13.0 | 187 | 13.0 | 152 | 12.0 | 119 | 11.0 | 96 | 10.0 | 74 | 10.0 | |
| 1,700 | 289 | 15.0 | 241 | 14.0 | 197 | 13.0 | 157 | 12.0 | 122 | 11.0 | 98 | 11.0 | 74 | 10.0 | |
| 1,800 | 304 | 15.0 | 252 | 15.0 | 205 | 14.0 | 163 | 13.0 | 127 | 12.0 | 102 | 11.0 | 76 | 10.0 | |
| 1,900 | 317 | 16.0 | 264 | 15.0 | 213 | 14.0 | 171 | 13.0 | 130 | 12.0 | 104 | 11.0 | 77 | 10.0 | |
| 2,000 | 335 | 16.0 | 275 | 16.0 | 222 | 15.0 | 177 | 14.0 | 135 | 12.0 | 108 | 12.0 | 79 | 11.0 | |
| 2,100 | 370 | 17.0 | 301 | 16.0 | 239 | 15.0 | 187 | 14.0 | 141 | 13.0 | 112 | 12.0 | 81 | 11.0 | |
| 2,200 | 388 | 18.0 | 314 | 17.0 | 249 | 15.0 | 194 | 14.0 | 146 | 13.0 | 117 | 12.0 | 84 | 11.0 | |
| 2,300 | 405 | 18.0 | 328 | 17.0 | 258 | 16.0 | 201 | 15.0 | 151 | 14.0 | 121 | 13.0 | 86 | 11.0 | |
| 2,400 | 422 | 19.0 | 339 | 18.0 | 267 | 16.0 | 207 | 15.0 | 154 | 14.0 | 123 | 13.0 | 87 | 12.0 | |
| 2,500 | 442 | 20.0 | 355 | 18.0 | 279 | 17.0 | 217 | 16.0 | 162 | 14.0 | 128 | 13.0 | 90 | 12.0 | |
| 2,600 | 511 | 20.0 | 390 | 19.0 | 300 | 17.0 | 230 | 16.0 | 170 | 15.0 | 132 | 14.0 | 93 | 12.0 | |
| 2,700 | 532 | 21.0 | 407 | 19.0 | 310 | 18.0 | 238 | 16.0 | 176 | 15.0 | 137 | 14.0 | 96 | 13.0 | |
| 2,800 | 553 | 22.0 | 420 | 20.0 | 322 | 18.0 | 245 | 17.0 | 181 | 15.0 | 141 | 14.0 | 98 | 13.0 | |
| 2,900 | 574 | 22.0 | 437 | 21.0 | 332 | 19.0 | 252 | 17.0 | 186 | 16.0 | 145 | 15.0 | 101 | 13.0 | |
| 3,000 | 600 | 23.0 | 454 | 21.0 | 344 | 19.0 | 261 | 18.0 | 192 | 16.0 | 150 | 15.0 | 104 | 13.0 | |
| 3,100 | | | 519 | 22.0 | 375 | 20.0 | 279 | 18.0 | 201 | 16.0 | 158 | 15.0 | 111 | 14.0 | |
| 3,200 | | | 537 | 23.0 | 386 | 20.0 | 287 | 19.0 | 205 | 17.0 | 162 | 16.0 | 113 | 14.0 | |
| 3,300 | | | 555 | 23.0 | 399 | 21.0 | 295 | 19.0 | 212 | 17.0 | 168 | 16.0 | 116 | 14.0 | |
| 3,400 | | | 575 | 24.0 | 411 | 22.0 | 303 | 20.0 | 217 | 18.0 | 173 | 16.0 | 118 | 15.0 | |
| 3,500 | | | 596 | 25.0 | 426 | 22.0 | 313 | 20.0 | 223 | 18.0 | 178 | 17.0 | 122 | 15.0 | |
| 3,600 | | | 784 | 25.0 | 469 | 23.0 | 334 | 20.0 | 233 | 18.0 | 182 | 17.0 | 125 | 15.0 | |
| 3,700 | | | | | 485 | 23.0 | 344 | 21.0 | 240 | 19.0 | 189 | 17.0 | 130 | 16.0 | |
| 3,800 | | | | | 500 | 24.0 | 352 | 21.0 | 246 | 19.0 | 193 | 18.0 | 135 | 16.0 | |
| 3,900 | | | | | 513 | 25.0 | 363 | 22.0 | 251 | 20.0 | 196 | 18.0 | 141 | 16.0 | |
| 4,000 | | | | | 530 | 25.0 | 373 | 22.0 | 258 | 20.0 | 203 | 19.0 | 143 | 17.0 | |
| 4,500 | | | | | 700 | 29.0 | 446 | 25.0 | 300 | 22.0 | 236 | 20.0 | 167 | 18.0 | |
| 5,000 | | | | | | | 540 | 28.0 | 346 | 24.0 | 265 | 22.0 | 189 | 20.0 | |
| 5,500 | | | | | | | 678 | 31.0 | 395 | 26.0 | 306 | 24.0 | 216 | 22.0 | |
| 6,000 | | | | | | | | | 458 | 29.0 | 341 | 26.0 | 242 | 24.0 | |
| 6,500 | | | | | | | | | 534 | 31.0 | 396 | 28.0 | 277 | 25.0 | |
| 7,000 | | | | | | | | | 640 | 34.0 | 436 | 31.0 | 306 | 27.0 | |
| 7,500 | | | | | | | | | | | 522 | 33.0 | 346 | 29.0 | |
| 8,000 | | | | | | | | | | | 571 | 36.0 | 381 | 32.0 | |
| 8,500 | | | | | | | | | | | | | 437 | 34.0 | |
| 9,000 | | | | | | | | | | | | | 477 | 36.0 | |
| 9,500 | | | | | | | | | | | | | 566 | 39.0 | |
| 10,000 | | | | | | | | | | | | | 614 | 42.0 | |

Table K-8. Rapid fire table for M109A2-A6/M198

| FUZE: M557, M564 | | PROPELLANT: Green Bag M3A1 | | |
|----------------------|-------|----------------------------|-------|-------|
| PIECE-TO-CREST RANGE | CHG 2 | CHG 3 | CHG 4 | CHG 5 |
| 100 | 64 | 62 | 61 | 59 |
| 200 | 47 | 43 | 40 | 37 |
| 300 | 48 | 40 | 36 | 31 |
| 400 | 53 | 43 | 37 | 31 |
| 500 | 62 | 48 | 40 | 33 |
| 600 | 69 | 52 | 43 | 35 |
| 700 | 77 | 58 | 45 | 37 |
| 800 | 86 | 64 | 52 | 40 |
| 900 | 96 | 72 | 56 | 43 |
| 1,000 | 108 | 80 | 61 | 47 |
| 1,100 | 116 | 86 | 66 | 50 |
| 1,200 | 126 | 93 | 71 | 54 |
| 1,300 | 137 | 99 | 76 | 58 |
| 1,400 | 147 | 106 | 81 | 62 |
| 1,500 | 160 | 116 | 87 | 66 |
| 1,600 | 172 | 123 | 95 | 71 |
| 1,700 | 181 | 129 | 99 | 75 |
| 1,800 | 192 | 137 | 105 | 79 |
| 1,900 | 204 | 144 | 111 | 84 |
| 2,000 | 221 | 155 | 117 | 89 |
| 2,100 | 232 | 164 | 123 | 93 |
| 2,200 | 245 | 170 | 129 | 100 |
| 2,300 | 256 | 179 | 135 | 105 |
| 2,400 | 269 | 187 | 141 | 110 |
| 2,500 | 290 | 199 | 150 | 115 |
| 2,600 | 303 | 208 | 155 | 119 |
| 2,700 | 315 | 216 | 161 | 124 |
| 2,800 | 329 | 224 | 167 | 129 |
| 2,900 | 341 | 232 | 175 | 134 |
| 3,000 | 370 | 247 | 183 | 140 |
| 3,100 | 385 | 256 | 189 | 145 |
| 3,200 | 398 | 264 | 196 | 150 |
| 3,300 | 414 | 273 | 202 | 155 |
| 3,400 | 430 | 284 | 208 | 160 |
| 3,500 | 469 | 300 | 219 | 168 |
| 3,600 | 486 | 309 | 225 | 173 |
| 3,700 | 504 | 320 | 232 | 178 |
| 3,800 | 522 | 330 | 241 | 183 |
| 3,900 | 541 | 339 | 247 | 189 |
| 4,000 | 607 | 362 | 259 | 197 |
| 4,500 | | 432 | 302 | 228 |
| 5,000 | | 521 | 350 | 262 |
| 5,500 | | 644 | 403 | 297 |
| 6,000 | | | 466 | 335 |
| 6,500 | | | 549 | 379 |
| 7,000 | | | 659 | 427 |
| 7,500 | | | | 483 |
| 8,000 | | | | 554 |
| 8,500 | | | | 646 |

Note: Charge 1 restriction due to possibility of a sticker (see TMs 9-2350-311-10 and 9-1025-211-10).

Table K-9. Rapid fire table for M109A2-A6/M198 (WB M4A2 [Chg 3-7] and M119 [Chg 8] propellant)

| FUZE: M557, M564 | | PROPELLANT: White Bag M4A2 (Chg 3-7), M119 (Chg 8) | | | | |
|----------------------|-------|--|-------|-------|-------|-------|
| PIECE-TO-CREST RANGE | CHG 3 | CHG 4 | CHG 5 | CHG 6 | CHG 7 | CHG 8 |
| 100 | 60 | 59 | 58 | 56 | 55 | 55 |
| 200 | 41 | 37 | 35 | 32 | 31 | 30 |
| 300 | 38 | 33 | 29 | 25 | 23 | 22 |
| 400 | 39 | 33 | 28 | 24 | 21 | 19 |
| 500 | 43 | 36 | 30 | 24 | 20 | 18 |
| 600 | 47 | 39 | 32 | 24 | 20 | 17 |
| 700 | 54 | 42 | 35 | 26 | 21 | 17 |
| 800 | 59 | 46 | 37 | 27 | 21 | 17 |
| 900 | 64 | 50 | 40 | 29 | 22 | 17 |
| 1,000 | 70 | 55 | 43 | 32 | 24 | 19 |
| 1,100 | 75 | 60 | 46 | 34 | 26 | 19 |
| 1,200 | 81 | 67 | 50 | 36 | 27 | 20 |
| 1,300 | 88 | 71 | 53 | 38 | 28 | 20 |
| 1,400 | 94 | 76 | 56 | 40 | 30 | 21 |
| 1,500 | 100 | 82 | 60 | 43 | 32 | 23 |
| 1,600 | 108 | 87 | 67 | 46 | 34 | 24 |
| 1,700 | 114 | 91 | 70 | 48 | 34 | 24 |
| 1,800 | 121 | 96 | 74 | 50 | 36 | 25 |
| 1,900 | 128 | 101 | 79 | 53 | 38 | 27 |
| 2,000 | 137 | 108 | 83 | 56 | 40 | 28 |
| 2,100 | 143 | 113 | 88 | 59 | 42 | 30 |
| 2,200 | 152 | 118 | 92 | 62 | 44 | 32 |
| 2,300 | 158 | 124 | 97 | 65 | 46 | 33 |
| 2,400 | 165 | 129 | 101 | 68 | 48 | 34 |
| 2,500 | 174 | 138 | 105 | 71 | 50 | 36 |
| 2,600 | 181 | 142 | 110 | 73 | 51 | 36 |
| 2,700 | 188 | 148 | 115 | 76 | 54 | 38 |
| 2,800 | 195 | 153 | 119 | 80 | 56 | 39 |
| 2,900 | 202 | 159 | 126 | 84 | 58 | 40 |
| 3,000 | 215 | 166 | 131 | 92 | 61 | 43 |
| 3,100 | 222 | 172 | 136 | 93 | 63 | 43 |
| 3,200 | 229 | 178 | 141 | 96 | 66 | 45 |
| 3,300 | 236 | 184 | 146 | 100 | 68 | 46 |
| 3,400 | 246 | 190 | 151 | 103 | 70 | 48 |
| 3,500 | 258 | 199 | 156 | 107 | 73 | 50 |
| 3,600 | 266 | 207 | 163 | 110 | 76 | 51 |
| 3,700 | 275 | 213 | 168 | 114 | 78 | 53 |
| 3,800 | 283 | 219 | 173 | 118 | 80 | 54 |
| 3,900 | 291 | 225 | 178 | 122 | 83 | 56 |
| 4,000 | 308 | 234 | 183 | 128 | 85 | 58 |
| 4,500 | 362 | 272 | 213 | 149 | 101 | 66 |
| 5,000 | 423 | 312 | 244 | 173 | 116 | 77 |
| 5,500 | 500 | 356 | 277 | 195 | 133 | 85 |
| 6,000 | 596 | 410 | 312 | 224 | 149 | 95 |
| 6,500 | | 468 | 352 | 249 | 172 | 109 |
| 7,000 | | 542 | 392 | 282 | 191 | 121 |
| 7,500 | | 642 | 442 | 310 | 215 | 135 |
| 8,000 | | | 499 | 348 | 238 | 149 |
| 8,500 | | | 569 | 394 | 266 | 167 |
| 9,000 | | | 660 | 428 | 291 | 183 |
| 9,500 | | | | 492 | 325 | 203 |
| 10,000 | | | | 531 | 352 | 222 |
| 10,500 | | | | 648 | 393 | 244 |
| 11,000 | | | | 697 | 423 | 266 |
| 11,500 | | | | | 478 | 291 |
| 12,000 | | | | | 513 | 315 |
| 12,500 | | | | | 597 | 347 |
| 13,000 | | | | | 639 | 372 |
| 13,500 | | | | | | 409 |
| 14,000 | | | | | | 438 |
| 14,500 | | | | | | 484 |
| 15,000 | | | | | | 516 |
| 15,500 | | | | | | 585 |
| 16,000 | | | | | | 622 |

Table K-10. Rapid fire table for M109A2-A6/M198 (fuze M514, propellant GB M3A1)

| FUZE: M514 | | PROPELLANT: Green Bag M3A1 | | | | | | | |
|----------------------|-------|----------------------------|-------|------|-------|------|-------|------|--|
| PIECE-TO-CREST RANGE | CHG 2 | | CHG 3 | | CHG 4 | | CHG 5 | | |
| | EL | TI | EL | TI | EL | TI | EL | TI | |
| 100 | 64 | 8.0 | 62 | 8.0 | 61 | 8.0 | 58 | 8.0 | |
| 200 | 47 | 8.0 | 43 | 8.0 | 40 | 8.0 | 36 | 8.0 | |
| 300 | 48 | 8.0 | 40 | 8.0 | 36 | 8.0 | 30 | 8.0 | |
| 400 | 253 | 8.0 | 43 | 8.0 | 37 | 8.0 | 30 | 8.0 | |
| 500 | 253 | 8.0 | 48 | 8.0 | 40 | 8.0 | 32 | 8.0 | |
| 600 | 231 | 9.0 | 213 | 8.0 | 43 | 8.0 | 35 | 8.0 | |
| 700 | 216 | 9.0 | 196 | 9.0 | 184 | 8.0 | 37 | 8.0 | |
| 800 | 208 | 9.0 | 185 | 9.0 | 172 | 9.0 | 160 | 8.0 | |
| 900 | 205 | 10.0 | 180 | 9.0 | 163 | 9.0 | 150 | 8.0 | |
| 1,000 | 204 | 10.0 | 176 | 10.0 | 157 | 9.0 | 143 | 9.0 | |
| 1,100 | 207 | 11.0 | 175 | 10.0 | 155 | 10.0 | 138 | 9.0 | |
| 1,200 | 209 | 11.0 | 174 | 10.0 | 152 | 10.0 | 135 | 9.0 | |
| 1,300 | 215 | 12.0 | 175 | 11.0 | 151 | 10.0 | 133 | 10.0 | |
| 1,400 | 220 | 12.0 | 176 | 11.0 | 151 | 11.0 | 131 | 10.0 | |
| 1,500 | 224 | 13.0 | 182 | 12.0 | 151 | 11.0 | 130 | 10.0 | |
| 1,600 | 238 | 13.0 | 186 | 12.0 | 156 | 11.0 | 132 | 11.0 | |
| 1,700 | 244 | 14.0 | 189 | 12.0 | 157 | 12.0 | 132 | 11.0 | |
| 1,800 | 252 | 14.0 | 194 | 13.0 | 160 | 12.0 | 134 | 11.0 | |
| 1,900 | 261 | 14.0 | 198 | 13.0 | 163 | 12.0 | 135 | 12.0 | |
| 2,000 | 269 | 15.0 | 203 | 14.0 | 165 | 13.0 | 137 | 12.0 | |
| 2,100 | 286 | 15.0 | 213 | 14.0 | 171 | 13.0 | 139 | 12.0 | |
| 2,200 | 298 | 16.0 | 220 | 14.0 | 176 | 13.0 | 145 | 12.0 | |
| 2,300 | 307 | 16.0 | 225 | 15.0 | 180 | 14.0 | 148 | 13.0 | |
| 2,400 | 318 | 17.0 | 231 | 15.0 | 184 | 14.0 | 151 | 13.0 | |
| 2,500 | 328 | 17.0 | 237 | 16.0 | 188 | 14.0 | 153 | 13.0 | |
| 2,600 | 354 | 18.0 | 250 | 16.0 | 194 | 15.0 | 157 | 14.0 | |
| 2,700 | 365 | 19.0 | 257 | 16.0 | 199 | 15.0 | 161 | 14.0 | |
| 2,800 | 378 | 19.0 | 264 | 17.0 | 204 | 15.0 | 165 | 14.0 | |
| 2,900 | 388 | 20.0 | 270 | 17.0 | 210 | 16.0 | 168 | 15.0 | |
| 3,000 | 402 | 20.0 | 279 | 18.0 | 215 | 16.0 | 172 | 15.0 | |
| 3,100 | 439 | 21.0 | 295 | 18.0 | 224 | 17.0 | 178 | 15.0 | |
| 3,200 | 451 | 21.0 | 302 | 19.0 | 230 | 17.0 | 182 | 16.0 | |
| 3,300 | 466 | 22.0 | 310 | 19.0 | 235 | 17.0 | 186 | 16.0 | |
| 3,400 | 481 | 22.0 | 320 | 19.0 | 240 | 18.0 | 191 | 16.0 | |
| 3,500 | 496 | 23.0 | 327 | 20.0 | 246 | 18.0 | 195 | 17.0 | |
| 3,600 | 558 | 24.0 | 347 | 20.0 | 257 | 18.0 | 202 | 17.0 | |
| 3,700 | 575 | 24.0 | 358 | 21.0 | 263 | 19.0 | 206 | 18.0 | |
| 3,800 | 592 | 25.0 | 366 | 21.0 | 271 | 19.0 | 211 | 18.0 | |
| 3,900 | 610 | 26.0 | 374 | 22.0 | 276 | 20.0 | 215 | 18.0 | |
| 4,000 | 630 | 26.0 | 385 | 22.0 | 282 | 20.0 | 220 | 19.0 | |
| 4,500 | | | 453 | 25.0 | 323 | 22.0 | 249 | 20.0 | |
| 5,000 | | | 514 | 28.0 | 369 | 24.0 | 281 | 22.0 | |
| 5,500 | | | 589 | 31.0 | 421 | 27.0 | 315 | 24.0 | |
| 6,000 | | | | | 482 | 29.0 | 351 | 26.0 | |
| 6,500 | | | | | 564 | 32.0 | 395 | 28.0 | |
| 7,000 | | | | | 673 | 35.0 | 441 | 30.0 | |
| 7,500 | | | | | | | 497 | 33.0 | |
| 8,000 | | | | | | | 566 | 35.0 | |
| 8,500 | | | | | | | 657 | 38.0 | |

Table K-11. Rapid fire table for M109A2-A6/M198 (fuze M514, propellants WBM4A2 [Chg 3-7] and M119 [Chg 8])

| FUZE: M514 | | PROPELLANT: White Bag M4A2 (Chg 3-7), M119 (Chg 8) | | | | | | | | | | | |
|----------------------|-------|--|-------|------|-------|------|-------|------|-------|------|-------|------|--|
| PIECE-TO-CREST RANGE | CHG 3 | | CHG 4 | | CHG 5 | | CHG 6 | | CHG 7 | | CHG 8 | | |
| | EL | TI | EL | TI | EL | TI | EL | TI | EL | TI | EL | TI | |
| 100 | 61 | 8.0 | 59 | 8.0 | 58 | 8.0 | 58 | 8.0 | 56 | 8.0 | 56 | 8.0 | |
| 200 | 41 | 8.0 | 37 | 8.0 | 35 | 8.0 | 34 | 8.0 | 32 | 8.0 | 31 | 8.0 | |
| 300 | 38 | 8.0 | 33 | 8.0 | 29 | 8.0 | 27 | 8.0 | 24 | 8.0 | 23 | 8.0 | |
| 400 | 39 | 8.0 | 33 | 8.0 | 28 | 8.0 | 26 | 8.0 | 22 | 8.0 | 20 | 8.0 | |
| 500 | 234 | 8.0 | 36 | 8.0 | 30 | 8.0 | 26 | 8.0 | 21 | 8.0 | 19 | 8.0 | |
| 600 | 207 | 8.0 | 40 | 8.0 | 32 | 8.0 | 26 | 8.0 | 21 | 8.0 | 18 | 8.0 | |
| 700 | 191 | 8.0 | 180 | 8.0 | 35 | 8.0 | 28 | 8.0 | 22 | 8.0 | 18 | 8.0 | |
| 800 | 179 | 9.0 | 167 | 8.0 | 157 | 8.0 | 29 | 8.0 | 22 | 8.0 | 18 | 8.0 | |
| 900 | 171 | 9.0 | 158 | 9.0 | 147 | 8.0 | 138 | 8.0 | 23 | 8.0 | 18 | 8.0 | |
| 1,000 | 166 | 9.0 | 152 | 9.0 | 139 | 9.0 | 129 | 8.0 | 25 | 8.0 | 20 | 8.0 | |
| 1,100 | 165 | 10.0 | 149 | 9.0 | 134 | 9.0 | 123 | 8.0 | 115 | 8.0 | 21 | 8.0 | |
| 1,200 | 163 | 10.0 | 148 | 10.0 | 130 | 9.0 | 117 | 9.0 | 108 | 8.0 | 22 | 8.0 | |
| 1,300 | 165 | 10.0 | 147 | 10.0 | 128 | 9.0 | 114 | 9.0 | 104 | 8.0 | 97 | 8.0 | |
| 1,400 | 165 | 11.0 | 146 | 10.0 | 125 | 10.0 | 110 | 9.0 | 100 | 9.0 | 92 | 8.0 | |
| 1,500 | 166 | 11.0 | 146 | 11.0 | 124 | 10.0 | 108 | 9.0 | 97 | 9.0 | 89 | 8.0 | |
| 1,600 | 170 | 12.0 | 148 | 11.0 | 127 | 10.0 | 107 | 9.0 | 95 | 9.0 | 86 | 8.0 | |
| 1,700 | 173 | 12.0 | 149 | 11.0 | 127 | 11.0 | 106 | 10.0 | 92 | 9.0 | 83 | 9.0 | |
| 1,800 | 178 | 12.0 | 151 | 12.0 | 128 | 11.0 | 105 | 10.0 | 91 | 9.0 | 81 | 9.0 | |
| 1,900 | 181 | 13.0 | 153 | 12.0 | 130 | 11.0 | 105 | 10.0 | 90 | 10.0 | 80 | 9.0 | |
| 2,000 | 185 | 13.0 | 156 | 12.0 | 131 | 12.0 | 105 | 11.0 | 89 | 10.0 | 78 | 9.0 | |
| 2,100 | 190 | 13.0 | 159 | 13.0 | 133 | 12.0 | 107 | 11.0 | 88 | 10.0 | 76 | 9.0 | |
| 2,200 | 198 | 14.0 | 163 | 13.0 | 136 | 12.0 | 109 | 11.0 | 89 | 10.0 | 77 | 9.0 | |
| 2,300 | 202 | 14.0 | 167 | 13.0 | 139 | 12.0 | 110 | 11.0 | 89 | 10.0 | 76 | 10.0 | |
| 2,400 | 207 | 15.0 | 170 | 14.0 | 141 | 13.0 | 111 | 12.0 | 89 | 11.0 | 75 | 10.0 | |
| 2,500 | 212 | 15.0 | 176 | 14.0 | 143 | 13.0 | 112 | 12.0 | 89 | 11.0 | 75 | 10.0 | |
| 2,600 | 222 | 15.0 | 181 | 14.0 | 147 | 13.0 | 113 | 12.0 | 89 | 11.0 | 74 | 10.0 | |
| 2,700 | 228 | 16.0 | 186 | 15.0 | 151 | 14.0 | 115 | 12.0 | 91 | 11.0 | 75 | 10.0 | |
| 2,800 | 234 | 16.0 | 190 | 15.0 | 154 | 14.0 | 118 | 13.0 | 92 | 12.0 | 75 | 11.0 | |
| 2,900 | 239 | 16.0 | 194 | 15.0 | 159 | 14.0 | 121 | 13.0 | 92 | 12.0 | 74 | 11.0 | |
| 3,000 | 247 | 17.0 | 198 | 16.0 | 163 | 14.0 | 123 | 13.0 | 93 | 12.0 | 75 | 11.0 | |
| 3,100 | 258 | 17.0 | 206 | 16.0 | 167 | 15.0 | 128 | 14.0 | 95 | 12.0 | 75 | 11.0 | |
| 3,200 | 264 | 18.0 | 211 | 17.0 | 171 | 15.0 | 130 | 14.0 | 97 | 13.0 | 76 | 11.0 | |
| 3,300 | 270 | 18.0 | 216 | 17.0 | 175 | 16.0 | 133 | 14.0 | 98 | 13.0 | 76 | 11.0 | |
| 3,400 | 279 | 18.0 | 221 | 17.0 | 179 | 16.0 | 135 | 15.0 | 99 | 13.0 | 77 | 12.0 | |
| 3,500 | 285 | 19.0 | 226 | 18.0 | 183 | 16.0 | 138 | 15.0 | 101 | 13.0 | 78 | 12.0 | |
| 3,600 | 300 | 19.0 | 237 | 18.0 | 190 | 17.0 | 141 | 15.0 | 103 | 13.0 | 79 | 12.0 | |
| 3,700 | 308 | 20.0 | 242 | 18.0 | 194 | 17.0 | 144 | 15.0 | 105 | 14.0 | 80 | 12.0 | |
| 3,800 | 315 | 20.0 | 247 | 19.0 | 198 | 17.0 | 147 | 15.0 | 106 | 14.0 | 80 | 12.0 | |
| 3,900 | 322 | 21.0 | 252 | 19.0 | 202 | 18.0 | 150 | 16.0 | 108 | 14.0 | 81 | 13.0 | |
| 4,000 | 331 | 21.0 | 257 | 19.0 | 206 | 18.0 | 153 | 16.0 | 109 | 15.0 | 82 | 13.0 | |
| 4,500 | 383 | 23.0 | 293 | 21.0 | 234 | 20.0 | 176 | 18.0 | 123 | 16.0 | 88 | 14.0 | |
| 5,000 | 442 | 26.0 | 331 | 23.0 | 263 | 22.0 | 195 | 20.0 | 137 | 17.0 | 97 | 15.0 | |
| 5,500 | 517 | 28.0 | 374 | 26.0 | 295 | 24.0 | 220 | 21.0 | 153 | 19.0 | 106 | 16.0 | |
| 6,000 | 614 | 31.0 | 426 | 28.0 | 328 | 25.0 | 244 | 23.0 | 167 | 20.0 | 115 | 17.0 | |
| 6,500 | | | 556 | 33.0 | 367 | 27.0 | 273 | 25.0 | 190 | 22.0 | 126 | 19.0 | |
| 7,000 | | | 655 | 36.0 | 406 | 30.0 | 301 | 27.0 | 208 | 24.0 | 137 | 20.0 | |
| 7,500 | | | | | 455 | 32.0 | 337 | 29.0 | 231 | 25.0 | 151 | 21.0 | |
| 8,000 | | | | | 511 | 34.0 | 365 | 31.0 | 254 | 27.0 | 164 | 23.0 | |
| 8,500 | | | | | 580 | 37.0 | 411 | 33.0 | 281 | 29.0 | 182 | 25.0 | |
| 9,000 | | | | | 671 | 39.0 | 446 | 35.0 | 307 | 31.0 | 198 | 26.0 | |
| 9,500 | | | | | | | 623 | 40.0 | 368 | 35.0 | 237 | 30.0 | |
| 10,000 | | | | | | | 667 | 42.0 | 408 | 37.0 | 258 | 31.0 | |
| 10,500 | | | | | | | 718 | 45.0 | 439 | 39.0 | 281 | 33.0 | |
| 11,000 | | | | | | | | | 493 | 41.0 | 305 | 35.0 | |
| 11,500 | | | | | | | | | 529 | 43.0 | 330 | 37.0 | |
| 12,000 | | | | | | | | | 614 | 46.0 | 363 | 39.0 | |
| 12,500 | | | | | | | | | 657 | 49.0 | 387 | 41.0 | |
| 13,000 | | | | | | | | | | | 425 | 43.0 | |
| 13,500 | | | | | | | | | | | 455 | 45.0 | |
| 14,000 | | | | | | | | | | | 501 | 47.0 | |
| 14,500 | | | | | | | | | | | 533 | 50.0 | |
| 15,000 | | | | | | | | | | | 605 | 52.0 | |
| 15,500 | | | | | | | | | | | 643 | 55.0 | |

Table K-12. Rapid fire table for M109A2-A6/M198 (M728 and M732 fuzes, propellant GB M3A1)

| FUZE: M728, M732 | | PROPELLANT: Green Bag M3A1 | | | | | | | | | |
|----------------------|-------|----------------------------|-------|------|-------|------|-------|------|----|----|--|
| PIECE-TO-CREST RANGE | CHG 2 | | CHG 3 | | CHG 4 | | CHG 5 | | | | |
| | EL | TI | EL | TI | EL | TI | EL | TI | EL | TI | |
| 100 | 64 | 8.0 | 62 | 8.0 | 61 | 8.0 | 58 | 8.0 | | | |
| 200 | 47 | 8.0 | 43 | 8.0 | 40 | 8.0 | 36 | 8.0 | | | |
| 300 | 48 | 8.0 | 40 | 8.0 | 36 | 8.0 | 30 | 8.0 | | | |
| 400 | 53 | 8.0 | 43 | 8.0 | 37 | 8.0 | 30 | 8.0 | | | |
| 500 | 194 | 8.0 | 48 | 8.0 | 40 | 8.0 | 32 | 8.0 | | | |
| 600 | 181 | 9.0 | 163 | 8.0 | 43 | 8.0 | 35 | 8.0 | | | |
| 700 | 173 | 9.0 | 153 | 9.0 | 141 | 8.0 | 37 | 8.0 | | | |
| 800 | 171 | 9.0 | 148 | 9.0 | 135 | 9.0 | 123 | 8.0 | | | |
| 900 | 172 | 10.0 | 147 | 9.0 | 130 | 9.0 | 117 | 8.0 | | | |
| 1,000 | 174 | 10.0 | 146 | 10.0 | 127 | 9.0 | 113 | 9.0 | | | |
| 1,100 | 179 | 11.0 | 147 | 10.0 | 127 | 10.0 | 110 | 9.0 | | | |
| 1,200 | 184 | 11.0 | 149 | 10.0 | 127 | 10.0 | 110 | 9.0 | | | |
| 1,300 | 191 | 12.0 | 151 | 11.0 | 127 | 10.0 | 109 | 10.0 | | | |
| 1,400 | 197 | 12.0 | 154 | 11.0 | 129 | 11.0 | 109 | 10.0 | | | |
| 1,500 | 204 | 13.0 | 160 | 12.0 | 131 | 11.0 | 110 | 10.0 | | | |
| 1,600 | 219 | 13.0 | 167 | 12.0 | 137 | 11.0 | 113 | 11.0 | | | |
| 1,700 | 226 | 14.0 | 171 | 12.0 | 139 | 12.0 | 114 | 11.0 | | | |
| 1,800 | 235 | 14.0 | 177 | 13.0 | 143 | 12.0 | 117 | 11.0 | | | |
| 1,900 | 245 | 14.0 | 182 | 13.0 | 147 | 12.0 | 119 | 12.0 | | | |
| 2,000 | 254 | 15.0 | 188 | 14.0 | 150 | 13.0 | 122 | 12.0 | | | |
| 2,100 | 272 | 15.0 | 199 | 14.0 | 157 | 13.0 | 125 | 12.0 | | | |
| 2,200 | 284 | 16.0 | 206 | 14.0 | 162 | 13.0 | 131 | 12.0 | | | |
| 2,300 | 294 | 16.0 | 212 | 15.0 | 167 | 14.0 | 135 | 13.0 | | | |
| 2,400 | 305 | 17.0 | 218 | 15.0 | 171 | 14.0 | 138 | 13.0 | | | |
| 2,500 | 316 | 17.0 | 225 | 16.0 | 176 | 14.0 | 141 | 13.0 | | | |
| 2,600 | 343 | 18.0 | 239 | 16.0 | 183 | 15.0 | 146 | 14.0 | | | |
| 2,700 | 354 | 19.0 | 246 | 16.0 | 188 | 15.0 | 150 | 14.0 | | | |
| 2,800 | 367 | 19.0 | 253 | 17.0 | 193 | 15.0 | 154 | 14.0 | | | |
| 2,900 | 378 | 20.0 | 260 | 17.0 | 200 | 16.0 | 158 | 15.0 | | | |
| 3,000 | 392 | 20.0 | 269 | 18.0 | 205 | 16.0 | 162 | 15.0 | | | |
| 3,100 | 430 | 21.0 | 286 | 18.0 | 215 | 17.0 | 169 | 15.0 | | | |
| 3,200 | 442 | 21.0 | 293 | 19.0 | 221 | 17.0 | 173 | 16.0 | | | |
| 3,300 | 457 | 22.0 | 301 | 19.0 | 226 | 17.0 | 177 | 16.0 | | | |
| 3,400 | 472 | 22.0 | 311 | 19.0 | 231 | 18.0 | 182 | 16.0 | | | |
| 3,500 | 488 | 23.0 | 319 | 20.0 | 238 | 18.0 | 187 | 17.0 | | | |
| 3,600 | 549 | 24.0 | 338 | 20.0 | 248 | 18.0 | 194 | 17.0 | | | |
| 3,700 | 567 | 24.0 | 349 | 21.0 | 255 | 19.0 | 198 | 18.0 | | | |
| 3,800 | 584 | 25.0 | 358 | 21.0 | 263 | 19.0 | 204 | 18.0 | | | |
| 3,900 | 602 | 26.0 | 367 | 22.0 | 269 | 20.0 | 208 | 18.0 | | | |
| 4,000 | 624 | 26.0 | 378 | 22.0 | 275 | 20.0 | 213 | 19.0 | | | |
| 4,500 | | | 446 | 25.0 | 316 | 22.0 | 242 | 20.0 | | | |
| 5,000 | | | 534 | 28.0 | 363 | 24.0 | 275 | 22.0 | | | |
| 5,500 | | | 656 | 31.0 | 415 | 27.0 | 309 | 24.0 | | | |
| 6,000 | | | | | 477 | 29.0 | 346 | 26.0 | | | |
| 6,500 | | | | | 559 | 32.0 | 390 | 28.0 | | | |
| 7,000 | | | | | 669 | 35.0 | 437 | 30.0 | | | |
| 7,500 | | | | | | | 493 | 33.0 | | | |
| 8,000 | | | | | | | 562 | 35.0 | | | |
| 8,500 | | | | | | | 654 | 38.0 | | | |

Note: No restrictions.

Table K-13. Rapid fire table for M109A2-A6/M198 (M728 and M732 fuzes, propellants WB M4A2 [Chg 3-7] and M119 [Chg 8])

| FUZE: M728, M732 | | PROPELLANT: WB M4A2 (Chg 3-7), M119 (Chg 8) | | | | | | | | | | |
|----------------------|-------|---|-------|------|-------|------|-------|------|-------|------|-------|------|
| PIECE-TO-CREST RANGE | CHG 3 | | CHG 4 | | CHG 5 | | CHG 6 | | CHG 7 | | CHG 8 | |
| | EL | TI | EL | TI | EL | TI | EL | TI | EL | TI | EL | TI |
| 100 | 61 | 8.0 | 59 | 8.0 | 58 | 8.0 | 57 | 8.0 | 56 | 8.0 | 56 | 8.0 |
| 200 | 41 | 8.0 | 37 | 8.0 | 35 | 8.0 | 33 | 8.0 | 32 | 8.0 | 31 | 8.0 |
| 300 | 38 | 8.0 | 33 | 8.0 | 29 | 8.0 | 26 | 8.0 | 24 | 8.0 | 23 | 8.0 |
| 400 | 39 | 8.0 | 33 | 8.0 | 28 | 8.0 | 25 | 8.0 | 22 | 8.0 | 20 | 8.0 |
| 500 | 43 | 8.0 | 36 | 8.0 | 30 | 8.0 | 25 | 8.0 | 21 | 8.0 | 19 | 8.0 |
| 600 | 181 | 8.0 | 40 | 8.0 | 32 | 8.0 | 25 | 8.0 | 21 | 8.0 | 18 | 8.0 |
| 700 | 148 | 8.0 | 137 | 8.0 | 35 | 8.0 | 27 | 8.0 | 22 | 8.0 | 18 | 8.0 |
| 800 | 132 | 9.0 | 130 | 8.0 | 120 | 8.0 | 28 | 8.0 | 22 | 8.0 | 18 | 8.0 |
| 900 | 138 | 9.0 | 125 | 9.0 | 113 | 8.0 | 105 | 8.0 | 23 | 8.0 | 18 | 8.0 |
| 1,000 | 136 | 9.0 | 122 | 9.0 | 108 | 9.0 | 99 | 8.0 | 25 | 8.0 | 20 | 8.0 |
| 1,100 | 137 | 10.0 | 121 | 9.0 | 106 | 9.0 | 95 | 8.0 | 87 | 8.0 | 21 | 8.0 |
| 1,200 | 138 | 10.0 | 123 | 10.0 | 105 | 9.0 | 92 | 9.0 | 83 | 8.0 | 21 | 8.0 |
| 1,300 | 141 | 10.0 | 123 | 10.0 | 104 | 9.0 | 90 | 9.0 | 80 | 8.0 | 72 | 8.0 |
| 1,400 | 143 | 11.0 | 124 | 10.0 | 103 | 10.0 | 88 | 9.0 | 78 | 9.0 | 69 | 8.0 |
| 1,500 | 146 | 11.0 | 126 | 11.0 | 104 | 10.0 | 88 | 9.0 | 77 | 9.0 | 68 | 8.0 |
| 1,600 | 151 | 12.0 | 129 | 11.0 | 108 | 10.0 | 88 | 10.0 | 76 | 9.0 | 67 | 8.0 |
| 1,700 | 155 | 12.0 | 131 | 11.0 | 109 | 11.0 | 88 | 10.0 | 74 | 9.0 | 65 | 9.0 |
| 1,800 | 161 | 12.0 | 134 | 12.0 | 111 | 11.0 | 88 | 10.0 | 74 | 9.0 | 64 | 9.0 |
| 1,900 | 165 | 13.0 | 137 | 12.0 | 114 | 11.0 | 89 | 10.0 | 74 | 10.0 | 64 | 9.0 |
| 2,000 | 170 | 13.0 | 141 | 12.0 | 116 | 12.0 | 90 | 11.0 | 74 | 10.0 | 63 | 9.0 |
| 2,100 | 176 | 13.0 | 145 | 13.0 | 119 | 12.0 | 93 | 11.0 | 74 | 10.0 | 62 | 9.0 |
| 2,200 | 184 | 14.0 | 149 | 13.0 | 122 | 12.0 | 95 | 11.0 | 75 | 10.0 | 63 | 9.0 |
| 2,300 | 189 | 14.0 | 154 | 13.0 | 126 | 13.0 | 97 | 11.0 | 76 | 10.0 | 63 | 10.0 |
| 2,400 | 194 | 15.0 | 157 | 14.0 | 128 | 13.0 | 98 | 12.0 | 76 | 11.0 | 62 | 10.0 |
| 2,500 | 200 | 15.0 | 164 | 14.0 | 131 | 13.0 | 100 | 12.0 | 77 | 11.0 | 63 | 10.0 |
| 2,600 | 211 | 15.0 | 170 | 14.0 | 136 | 13.0 | 102 | 12.0 | 78 | 11.0 | 63 | 10.0 |
| 2,700 | 217 | 16.0 | 175 | 15.0 | 140 | 14.0 | 104 | 12.0 | 80 | 11.0 | 64 | 10.0 |
| 2,800 | 223 | 16.0 | 179 | 15.0 | 143 | 14.0 | 107 | 13.0 | 81 | 12.0 | 64 | 11.0 |
| 2,900 | 229 | 16.0 | 184 | 15.0 | 149 | 14.0 | 111 | 13.0 | 82 | 12.0 | 64 | 11.0 |
| 3,000 | 237 | 17.0 | 188 | 16.0 | 153 | 15.0 | 113 | 13.0 | 83 | 12.0 | 65 | 11.0 |
| 3,100 | 249 | 17.0 | 197 | 16.0 | 158 | 15.0 | 119 | 14.0 | 86 | 12.0 | 66 | 11.0 |
| 3,200 | 255 | 18.0 | 202 | 17.0 | 162 | 15.0 | 121 | 14.0 | 88 | 12.0 | 67 | 11.0 |
| 3,300 | 262 | 18.0 | 207 | 17.0 | 166 | 16.0 | 124 | 14.0 | 89 | 13.0 | 67 | 11.0 |
| 3,400 | 270 | 18.0 | 212 | 17.0 | 170 | 16.0 | 126 | 15.0 | 90 | 13.0 | 68 | 12.0 |
| 3,500 | 277 | 19.0 | 218 | 18.0 | 175 | 16.0 | 130 | 15.0 | 93 | 13.0 | 70 | 12.0 |
| 3,600 | 291 | 19.0 | 228 | 18.0 | 181 | 17.0 | 132 | 15.0 | 94 | 13.0 | 70 | 12.0 |
| 3,700 | 300 | 20.0 | 234 | 18.0 | 186 | 17.0 | 136 | 15.0 | 97 | 14.0 | 72 | 12.0 |
| 3,800 | 307 | 20.0 | 239 | 19.0 | 190 | 17.0 | 139 | 16.0 | 98 | 14.0 | 72 | 12.0 |
| 3,900 | 315 | 21.0 | 245 | 19.0 | 195 | 18.0 | 143 | 16.0 | 101 | 14.0 | 74 | 13.0 |
| 4,000 | 324 | 21.0 | 250 | 19.0 | 199 | 18.0 | 146 | 16.0 | 102 | 14.0 | 75 | 13.0 |
| 4,500 | 376 | 21.0 | 286 | 21.0 | 227 | 20.0 | 169 | 17.0 | 116 | 16.0 | 81 | 14.0 |
| 5,000 | 436 | 26.0 | 325 | 23.0 | 257 | 22.0 | 189 | 20.0 | 131 | 17.0 | 91 | 15.0 |
| 5,500 | 511 | 28.0 | 368 | 26.0 | 289 | 24.0 | 214 | 21.0 | 147 | 19.0 | 100 | 16.0 |
| 6,000 | 609 | 31.0 | 421 | 28.0 | 323 | 26.0 | 239 | 23.0 | 162 | 20.0 | 110 | 17.0 |
| 6,500 | | | 479 | 30.0 | 362 | 28.0 | 268 | 25.0 | 185 | 22.0 | 121 | 19.0 |
| 7,000 | | | 552 | 33.0 | 402 | 30.0 | 297 | 27.0 | 204 | 24.0 | 133 | 20.0 |
| 7,500 | | | 651 | 36.0 | 451 | 32.0 | 343 | 29.0 | 227 | 25.0 | 147 | 21.0 |
| 8,000 | | | | | 507 | 34.0 | 361 | 31.0 | 250 | 27.0 | 160 | 23.0 |
| 8,500 | | | | | 577 | 37.0 | 408 | 33.0 | 278 | 29.0 | 179 | 25.0 |
| 9,000 | | | | | 667 | 40.0 | 442 | 35.0 | 303 | 31.0 | 194 | 26.0 |
| 9,500 | | | | | | | 546 | 40.0 | 365 | 35.0 | 234 | 30.0 |
| 10,000 | | | | | | | 664 | 42.0 | 405 | 37.0 | 255 | 31.0 |
| 10,500 | | | | | | | | | 436 | 39.0 | 278 | 33.0 |
| 11,000 | | | | | | | | | 491 | 41.0 | 303 | 35.0 |
| 11,500 | | | | | | | | | 526 | 43.0 | 327 | 37.0 |
| 12,000 | | | | | | | | | 611 | 46.0 | 360 | 39.0 |
| 12,500 | | | | | | | | | 655 | 49.0 | 385 | 41.0 |
| 13,000 | | | | | | | | | | | 423 | 43.0 |
| 13,500 | | | | | | | | | | | 453 | 45.0 |
| 14,000 | | | | | | | | | | | 498 | 47.0 |
| 14,500 | | | | | | | | | | | 531 | 50.0 |
| 15,000 | | | | | | | | | | | 603 | 52.0 |
| 15,500 | | | | | | | | | | | 641 | 55.0 |

Note: No restrictions.

Table K-14. Rapid fire table for M109A2-A6/M198 (M557 and M564 fuzes, all authorized propellants)

| FUZE: M557/564 | | ROCKET ON ONLY | | SHELL RAP | ALL AUTHORIZED PROPELLANTS | | |
|----------------|---------|----------------|----------|-----------|----------------------------|---------|----------|
| PCR | CHG 7RB | CHG 8WB | CHG M203 | PCR | CHG 7RB | CHG 8WB | CHG M203 |
| 100 | 55 | 55 | 54 | 7,500 | 165 | 113 | 77 |
| 200 | 32 | 31 | 30 | 8,000 | 177 | 123 | 85 |
| 300 | 24 | 23 | 22 | 8,500 | 192 | 132 | 91 |
| 400 | 22 | 20 | 18 | 9,000 | 206 | 141 | 97 |
| 500 | 21 | 19 | 17 | 9,500 | 221 | 151 | 103 |
| 600 | 21 | 18 | 16 | 10,000 | 238 | 161 | 109 |
| 700 | 22 | 18 | 16 | 10,500 | 256 | 170 | 114 |
| 800 | 22 | 18 | 15 | 11,000 | 273 | 184 | 121 |
| 900 | 23 | 19 | 15 | 11,500 | 295 | 196 | 129 |
| 1,000 | 25 | 20 | 16 | 12,000 | 313 | 208 | 138 |
| 1,100 | 26 | 20 | 16 | 12,500 | 339 | 223 | 143 |
| 1,200 | 28 | 21 | 17 | 13,000 | 360 | 237 | 152 |
| 1,300 | 29 | 21 | 16 | 13,500 | 389 | 251 | 160 |
| 1,400 | 31 | 23 | 17 | 14,000 | 412 | 268 | 170 |
| 1,500 | 32 | 24 | 18 | 14,500 | 447 | 285 | 175 |
| 1,600 | 34 | 25 | 19 | 15,000 | 474 | 302 | 187 |
| 1,700 | 35 | 25 | 19 | 15,500 | 515 | 324 | 198 |
| 1,800 | 37 | 27 | 19 | 16,000 | 545 | 343 | 209 |
| 1,900 | 39 | 28 | 20 | 16,500 | 601 | 366 | 214 |
| 2,000 | 41 | 29 | 21 | 17,000 | 636 | 387 | 229 |
| 2,100 | 43 | 31 | 22 | 17,500 | 728 | 416 | 242 |
| 2,200 | 44 | 33 | 23 | 18,000 | 771 | 440 | 256 |
| 2,300 | 46 | 34 | 24 | 18,500 | 1,173 | 471 | 266 |
| 2,400 | 48 | 35 | 25 | 19,000 | 1,241 | 498 | 281 |
| 2,500 | 50 | 37 | 25 | 19,500 | | 538 | 297 |
| 2,600 | 51 | 37 | 25 | 20,000 | | 567 | 315 |
| 2,700 | 53 | 39 | 26 | 20,500 | | 622 | 328 |
| 2,800 | 55 | 40 | 27 | 21,000 | | 657 | 347 |
| 2,900 | 57 | 41 | 28 | 21,500 | | 745 | 365 |
| 3,000 | 60 | 43 | 29 | 22,000 | | 789 | 383 |
| 3,100 | 63 | 44 | 30 | 22,500 | | | 404 |
| 3,200 | 66 | 46 | 31 | 23,000 | | | 425 |
| 3,300 | 67 | 47 | 32 | 23,500 | | | 445 |
| 3,400 | 69 | 49 | 33 | 24,000 | | | 468 |
| 3,500 | 71 | 50 | 34 | 24,500 | | | 500 |
| 3,600 | 74 | 52 | 35 | 25,000 | | | 525 |
| 3,700 | 76 | 53 | 36 | 25,500 | | | 550 |
| 3,800 | 78 | 55 | 37 | 26,000 | | | 577 |
| 3,900 | 80 | 56 | 38 | 26,500 | | | 648 |
| 4,000 | 83 | 58 | 39 | 27,000 | | | 577 |
| 4,500 | 94 | 66 | 44 | 27,500 | | | 648 |
| 5,000 | 107 | 73 | 49 | 28,000 | | | 525 |
| 5,500 | 117 | 82 | 54 | 28,500 | | | 550 |
| 6,000 | 128 | 90 | 60 | 29,000 | | | 577 |
| 6,500 | 141 | 97 | 65 | 29,500 | | | 648 |
| 7,000 | 152 | 105 | 71 | | | | |

Table K-15. Rapid fire table for M109A2-A6/M198 (shell DPICM, all propellants)

| SHELL DPICM | | ALL PROPELLANTS | | | | | | | |
|-------------|---------|-----------------|---------|---------|---------|---------|---------|---------|---------|
| PCR | CHG 3GB | CHG 3WB | CHG 4GB | CHG 4WB | CHG 5GB | CHG 5WB | CHG 6WB | CHG 7RB | CHG 7WB |
| 100 | 62 | 61 | 59 | 58 | 58 | 57 | 56 | 55 | 55 |
| 200 | 44 | 42 | 41 | 38 | 37 | 35 | 33 | 31 | 32 |
| 300 | 43 | 39 | 37 | 34 | 32 | 30 | 27 | 23 | 25 |
| 400 | 46 | 41 | 39 | 35 | 32 | 30 | 25 | 20 | 22 |
| 500 | 51 | 45 | 43 | 38 | 34 | 31 | 26 | 19 | 22 |
| 600 | 58 | 50 | 47 | 41 | 37 | 34 | 28 | 18 | 22 |
| 700 | 65 | 55 | 51 | 45 | 40 | 37 | 29 | 19 | 23 |
| 800 | 71 | 62 | 56 | 49 | 44 | 39 | 31 | 19 | 24 |
| 900 | 78 | 68 | 61 | 54 | 47 | 42 | 32 | 19 | 24 |
| 1,000 | 88 | 74 | 67 | 59 | 52 | 46 | 35 | 20 | 26 |
| 1,100 | 96 | 81 | 72 | 64 | 56 | 49 | 37 | 22 | 28 |
| 1,200 | 104 | 87 | 80 | 69 | 61 | 53 | 40 | 23 | 30 |
| 1,300 | 111 | 92 | 85 | 73 | 64 | 56 | 42 | 23 | 31 |
| 1,400 | 119 | 99 | 91 | 78 | 69 | 60 | 44 | 25 | 33 |
| 1,500 | 127 | 108 | 97 | 86 | 73 | 65 | 47 | 26 | 35 |
| 1,600 | 140 | 117 | 104 | 92 | 79 | 70 | 50 | 27 | 37 |
| 1,700 | 149 | 123 | 111 | 96 | 83 | 73 | 52 | 28 | 38 |
| 1,800 | 157 | 130 | 117 | 102 | 88 | 77 | 55 | 29 | 40 |
| 1,900 | 165 | 137 | 123 | 107 | 92 | 82 | 58 | 30 | 42 |
| 2,000 | 174 | 145 | 130 | 113 | 97 | 86 | 62 | 32 | 44 |
| 2,100 | 188 | 155 | 138 | 120 | 103 | 92 | 66 | 33 | 47 |
| 2,200 | 196 | 162 | 147 | 126 | 108 | 96 | 69 | 34 | 50 |
| 2,300 | 207 | 169 | 153 | 132 | 113 | 103 | 72 | 36 | 52 |
| 2,400 | 216 | 177 | 160 | 137 | 118 | 107 | 76 | 37 | 54 |
| 2,500 | 224 | 186 | 167 | 143 | 123 | 112 | 79 | 39 | 56 |
| 2,600 | 241 | 196 | 172 | 150 | 129 | 117 | 82 | 39 | 58 |
| 2,700 | 250 | 203 | 183 | 156 | 134 | 121 | 86 | 41 | 60 |
| 2,800 | 262 | 211 | 190 | 164 | 139 | 126 | 89 | 42 | 62 |
| 2,900 | 271 | 218 | 197 | 170 | 144 | 131 | 93 | 44 | 65 |
| 3,000 | 281 | 228 | 204 | 176 | 150 | 136 | 96 | 45 | 67 |
| 3,100 | 303 | 243 | 211 | 185 | 157 | 143 | 101 | 47 | 70 |
| 3,200 | 313 | 251 | 224 | 191 | 162 | 148 | 105 | 48 | 73 |
| 3,300 | 325 | 258 | 232 | 197 | 168 | 153 | 109 | 50 | 75 |
| 3,400 | 335 | 268 | 241 | 203 | 173 | 158 | 112 | 52 | 78 |
| 3,500 | 346 | 277 | 248 | 209 | 181 | 163 | 116 | 53 | 80 |
| 3,600 | 376 | 294 | 256 | 221 | 190 | 170 | 121 | 55 | 83 |
| 3,700 | 387 | 302 | 271 | 227 | 195 | 175 | 127 | 57 | 86 |
| 3,800 | 398 | 313 | 278 | 236 | 201 | 181 | 131 | 58 | 88 |
| 3,900 | 411 | 321 | 286 | 242 | 207 | 186 | 135 | 60 | 91 |
| 4,000 | 423 | 330 | 294 | 249 | 212 | 191 | 139 | 62 | 94 |
| 4,500 | 523 | 392 | 338 | 289 | 246 | 224 | 163 | 72 | 109 |
| 5,000 | 671 | 468 | 394 | 335 | 282 | 256 | 186 | 81 | 125 |
| 5,500 | 1,068 | 563 | 460 | 386 | 323 | 289 | 211 | 93 | 145 |
| 6,000 | | 709 | | 447 | 367 | 329 | 241 | 104 | 163 |
| 6,500 | | 1,087 | | 521 | 420 | 371 | 270 | 117 | 185 |
| 7,000 | | | | 622 | 479 | 420 | 300 | 129 | 205 |
| 7,500 | | | | 783 | 556 | 478 | 336 | 145 | 232 |
| 8,000 | | | | | 661 | 548 | 372 | 160 | 254 |
| 8,500 | | | | | 854 | 642 | 413 | 177 | 284 |
| 9,000 | | | | | | 796 | 461 | 195 | 309 |
| 9,500 | | | | | | | 516 | 214 | 346 |
| 10,000 | | | | | | | 585 | 232 | 374 |
| 10,500 | | | | | | | 676 | 374 | 420 |
| 11,000 | | | | | | | 829 | 278 | 451 |
| 11,500 | | | | | | | | 307 | 514 |
| 12,000 | | | | | | | | 329 | 550 |
| 12,500 | | | | | | | | 363 | 661 |
| 13,000 | | | | | | | | 388 | 709 |
| 13,500 | | | | | | | | 429 | |
| 14,000 | | | | | | | | 459 | |
| 14,500 | | | | | | | | 509 | |
| 15,000 | | | | | | | | 542 | |
| 15,500 | | | | | | | | 619 | |
| 16,000 | | | | | | | | 660 | |
| 16,500 | | | | | | | | 845 | |
| 17,000 | | | | | | | | 902 | |

Table K-16. Rapid fire table for M109A2-A6/M198 (shell Copperhead, all authorized propellant)

| SHELL COPPERHEAD | | ALL AUTHORIZED PROPELLANT | | | |
|------------------|---------|---------------------------|---------|---------|---------|
| PCR | CHG 4GB | CHG 5GB | CHG 6WB | CHG 7WB | CHG 8WB |
| 100 | 99 | 97 | 95 | 94 | 93 |
| 200 | 82 | 78 | 75 | 73 | 71 |
| 300 | 82 | 76 | 70 | 67 | 65 |
| 400 | 86 | 79 | 71 | 67 | 63 |
| 500 | 93 | 83 | 73 | 68 | 64 |
| 600 | 100 | 88 | 76 | 70 | 65 |
| 700 | 107 | 93 | 79 | 72 | 67 |
| 800 | 115 | 99 | 83 | 75 | 68 |
| 900 | 123 | 105 | 87 | 78 | 70 |
| 1,000 | 132 | 112 | 92 | 81 | 73 |
| 1,100 | 141 | 118 | 96 | 84 | 75 |
| 1,200 | 150 | 125 | 101 | 88 | 77 |
| 1,300 | 159 | 132 | 105 | 91 | 79 |
| 1,400 | 169 | 139 | 110 | 95 | 82 |
| 1,500 | 179 | 147 | 116 | 99 | 85 |
| 1,600 | 189 | 154 | 121 | 103 | 88 |
| 1,700 | 198 | 161 | 126 | 106 | 90 |
| 1,800 | 209 | 169 | 131 | 110 | 93 |
| 1,900 | 220 | 177 | 137 | 115 | 96 |
| 2,000 | 231 | 185 | 143 | 119 | 100 |
| 2,100 | 242 | 194 | 149 | 124 | 103 |
| 2,200 | 253 | 202 | 155 | 128 | 106 |
| 2,300 | 265 | 211 | 161 | 133 | 109 |
| 2,400 | 277 | 219 | 167 | 138 | 113 |
| 2,500 | 289 | 228 | 174 | 142 | 116 |
| 2,600 | 301 | 236 | 179 | 146 | 119 |
| 2,700 | 314 | 245 | 185 | 151 | 122 |
| 2,800 | 327 | 255 | 192 | 156 | 126 |
| 2,900 | 341 | 264 | 199 | 162 | 130 |
| 3,000 | 356 | 274 | 206 | 167 | 133 |

APPENDIX L
GUN DISPLAY UNIT

L-1. DESCRIPTION

The gun display unit links the howitzer into the BCS. At each gun, the GDU displays firing data and fire commands from the BCS and transmits the status of the gun to the BCS throughout the fire mission. The GDU consists of a section chief's assembly (SCA), the case assembly (CA), and two gun assemblies. The section chief receives his fire commands on the SCA. At the same time, the deflection and quadrant elevation are displayed on the gunner's and assistant gunner's gun assemblies, respectively. Wire, the AN/PRC 68, or the AN/PRC 126 radio, is used for communication with the BCS.

L-2. SECTION CHIEF'S ASSEMBLY

a. The SCA (Figure L-1) gives the section chief a display of firing data and commands to fire. The SCA can be connected to the case assembly and to a headset.

b. The following data can be displayed on the SCA:

- Mission.
- Special instructions.
- Shell.
- Powder lot.
- Charge.
- Fuze.
- Fuze setting.
- Fire commands.
- Deflection.
- Quadrant elevation.
- FFE data.

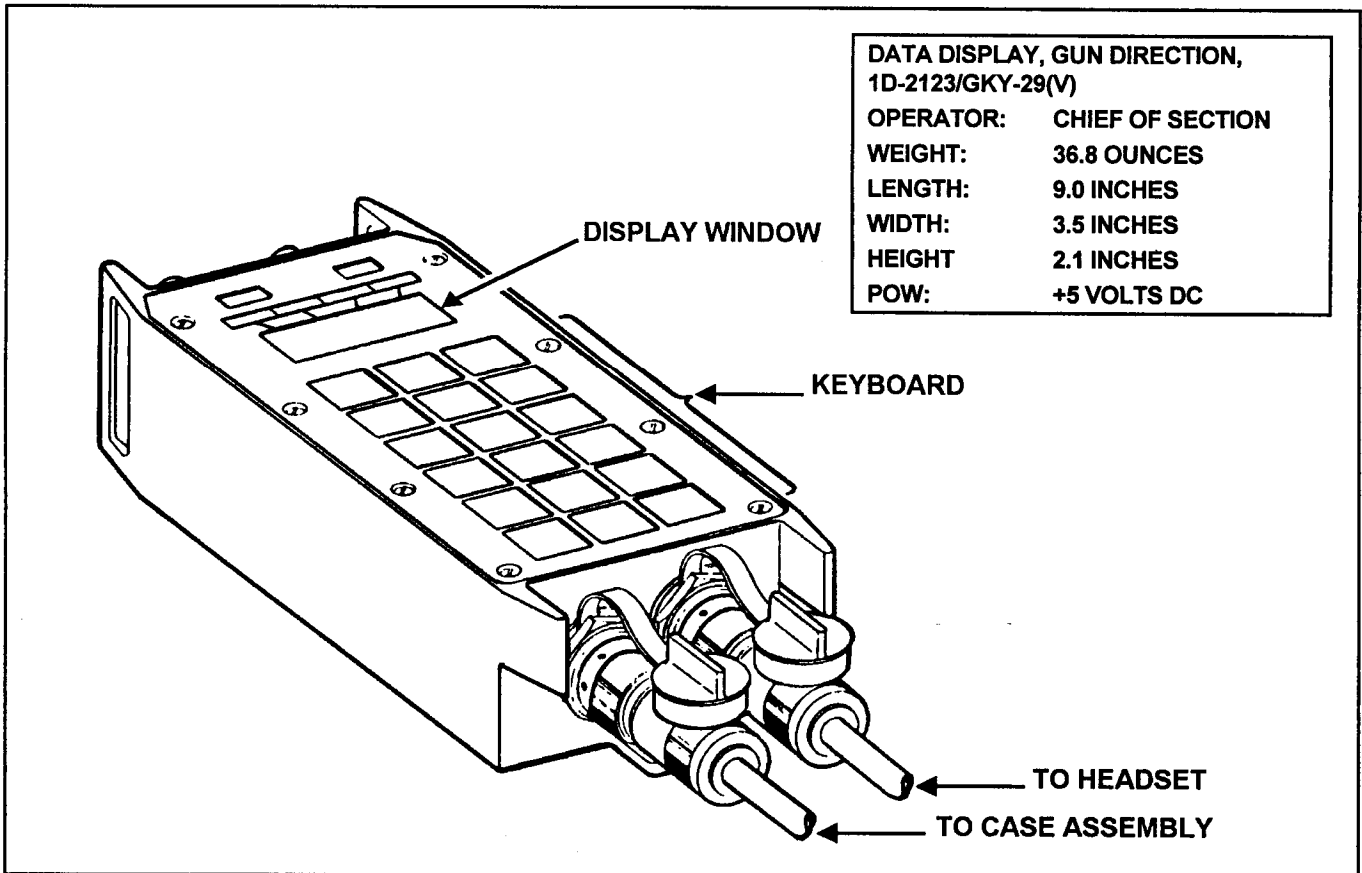

Figure L-1. Section chief's assembly

c. The keyboard allows selection of piece data, sending status to the BCS, and self test. The controls, indicators, and connectors (Figure L-2) are discussed below.

(1) The panel control is used to vary the lighting intensity of keys and legends. It has ON and OFF positions.

(2) The display control is used to vary the brightness of the display window data.

(3) The display window shows red letters and numbers of firing data and command bars. DNL, AMC, and FIRE bars are not lit except during fire missions.

(4) The MSN MOF/1 key is pressed to show the section number and mission number in the display window.

(5) The SP INST/2 key is pressed to display special instructions of azimuth, high angle, or gunner's quadrant or to enter the section number in the display window.

(6) The SH/3 key is pressed to show the shell to be used in adjustment or to enter the section number in the display window.

(7) The LOT/4 key is pressed to show the projectile and powder lot or to enter the section number in the display window.

(8) The CHG/5 is pressed to show the charge to fire or to enter the section number in the display window.

(9) The FZ/6 key is pressed to show the to to be used in adjustment or to enter the section number in the display window.

(10) The FZ SET/7 key is pressed to show the fuze setting or to enter the section number in the display window.

(11) The DF/8 key is pressed to show the deflection or to enter the section number in the display window.

(12) The QE/9 key is pressed to show the quadrant elevation in adjustment or to enter the section number in the display window.

(13) The FFE SH key is pressed to show the FFE shell data in the display window.

(14) The FFE LOT/0 key is pressed to show the FFE lot data or to enter the section number in the display window.

(15) The FFE RDS key is pressed to show the number of FFE rounds in the display window.

(16) The FFE FZ key is pressed to show the FFE fuze data in the display window.

(17) The READY key is pressed to lock in the section number and is pressed when the piece is ready. The ready message is sent to the BCS.

(18) The SHOT/RC key is pressed once after the first round is fired. It causes SHOT to show in the display window and sends the SHOT message to the BCS. It is pressed again when the last round is fired. This causes RC (rounds complete) to show in the display window and sends the ROUNDS COMPLETE message to the BCS.

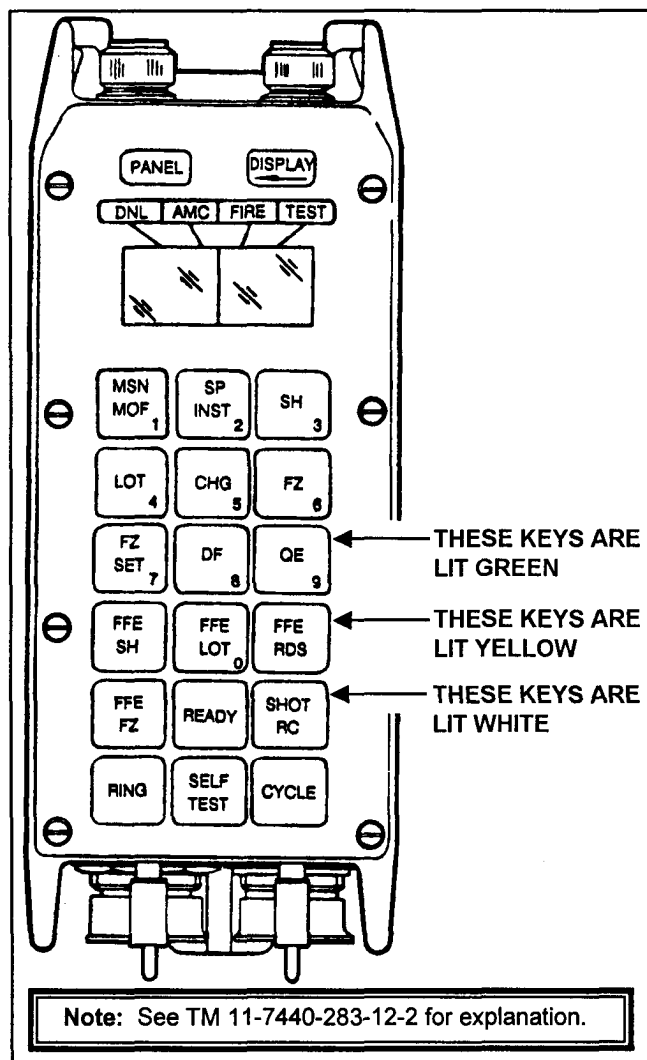

Figure L-2. Section chief's assembly controls, indicators, and connectors

Note: In one round FFE missions and during the adjustment phase, the section chief must ensure that he presses the **SHOT/RC** key twice after firing or he may not receive data for the next adjustment/mission.

(19) The SELF TEST key is pressed to start the GDU self-diagnostic test.

(20) The CYCLE key is pressed to acknowledge to the FDC the receipt of a message. It silences the alarm and causes the gun number and mission number or updated firing data to show in the display window. The SCA window goes blank 15 seconds after the last key is pressed. Pressing the CYCLE key causes the display to reappear.

L-3. CASE ASSEMBLY

a. The case assembly (Figure L-3) provides circuits for data reception and transmission and for power conversion required for GDU operation.

b. In the battery compartment are the active battery and a spare battery.

c. The power supply unit provides power and data circuits.

d. There are connectors for the SCA, power, and data.

e. Binding posts allow for the connection of the following:

- Quadrant elevation gun assembly.
- Deflection gun assembly.
- LCU (labeled BCU on the case assembly).
- Auxiliary power.

f. The controls, indicators, and connections (Figure L-4) are discussed below.

(1) The POWER connector allows power connection between the case assembly and the radio.

(2) The DEF 1, DEF 2, and DEF 3 binding posts allow connection of field wire between the case assembly and the power, ground, and signal binding post, respectively, on the deflection gun assembly.

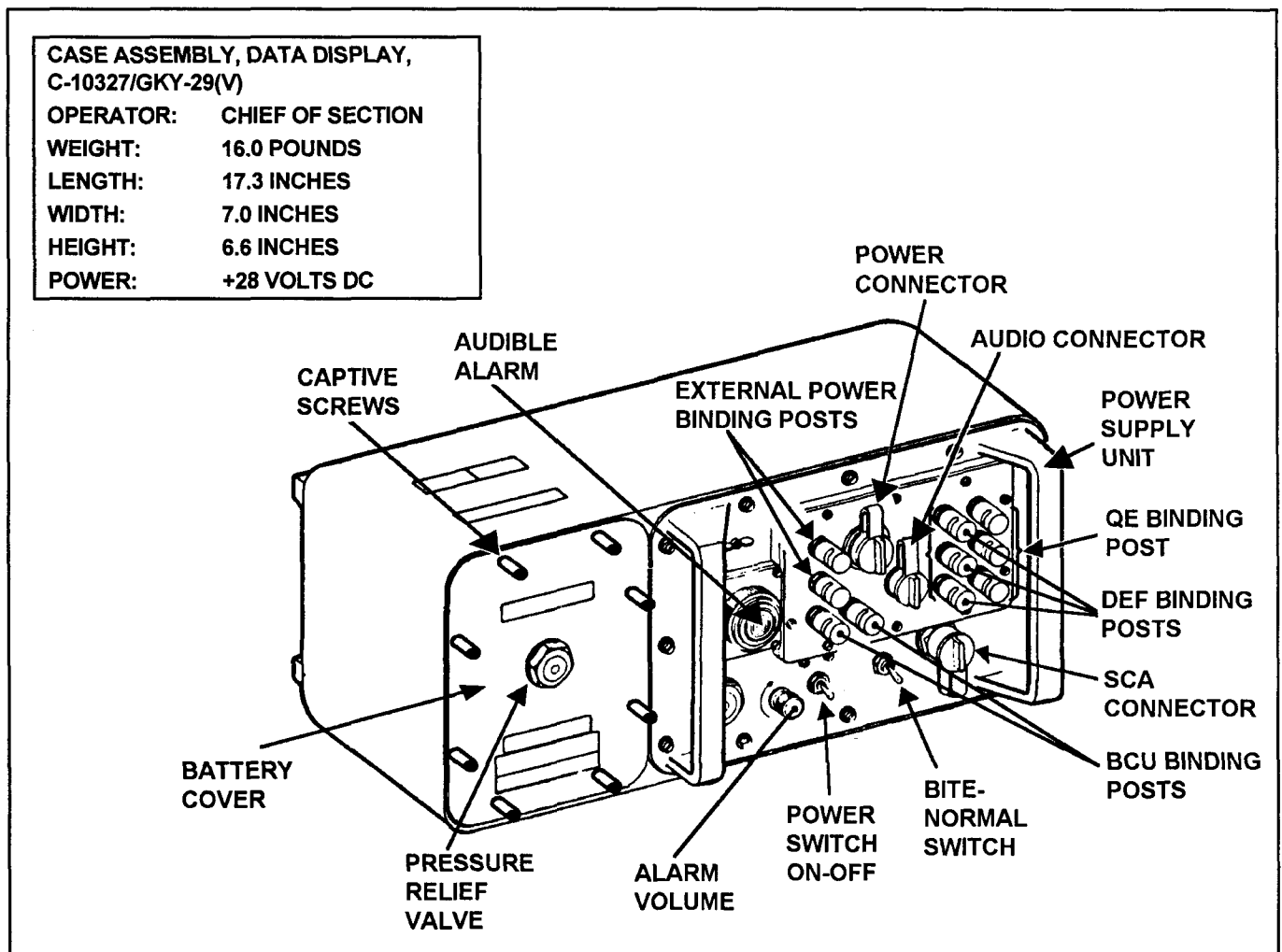

Figure L-3. Case assembly

(3) The QE 1, QE 2, and QE 3 binding posts allow connection of field wire between the case assembly and the power, ground, and signal binding posts respectively on the quadrant elevation gun assembly.

(4) The AUDIO connector allows signal connection between the case assembly and the radio.

(5) The BCU binding posts allow signal connection between the case assembly and the BCS (through the wire line adapter).

(6) The 28V AUX POWER binding post allows connection to an external 28 volt power source.

(7) The GND connector allows connection to earth ground.

(8) The alarm gives an audible alert to the operator when the GDU is receiving a message.

(9) The ALARM control is used to vary the volume of the audible alarm. (To increase the volume, turn the control clockwise.)

(10) The POWER ON-OFF switch is used to give primary power to the case assembly.

(11) When placed in the NORMAL position, the NORMAL-BITE switch allows digital communications between the BCS and the GDU. In the BITE position, it completes the BITE circuit.

(12) The SCA connector allows signal connections between the case assembly and the SCA.

L-4. GUN ASSEMBLY

a. The gun assembly (Figure L-5) provides instant identification of required deflection to the gunner or elevation to the assistant gunner.

b. The display window shows quadrant elevation or deflection information. The tenths digit shows on the QE display only when the special instruction of GUNNER'S QUADRANT is received.

c. Three binding posts allow connection to the case assembly as follows:

(1) The TERM 1 binding post is used to connect field wire between the gun assembly and the power binding post on the case assembly.

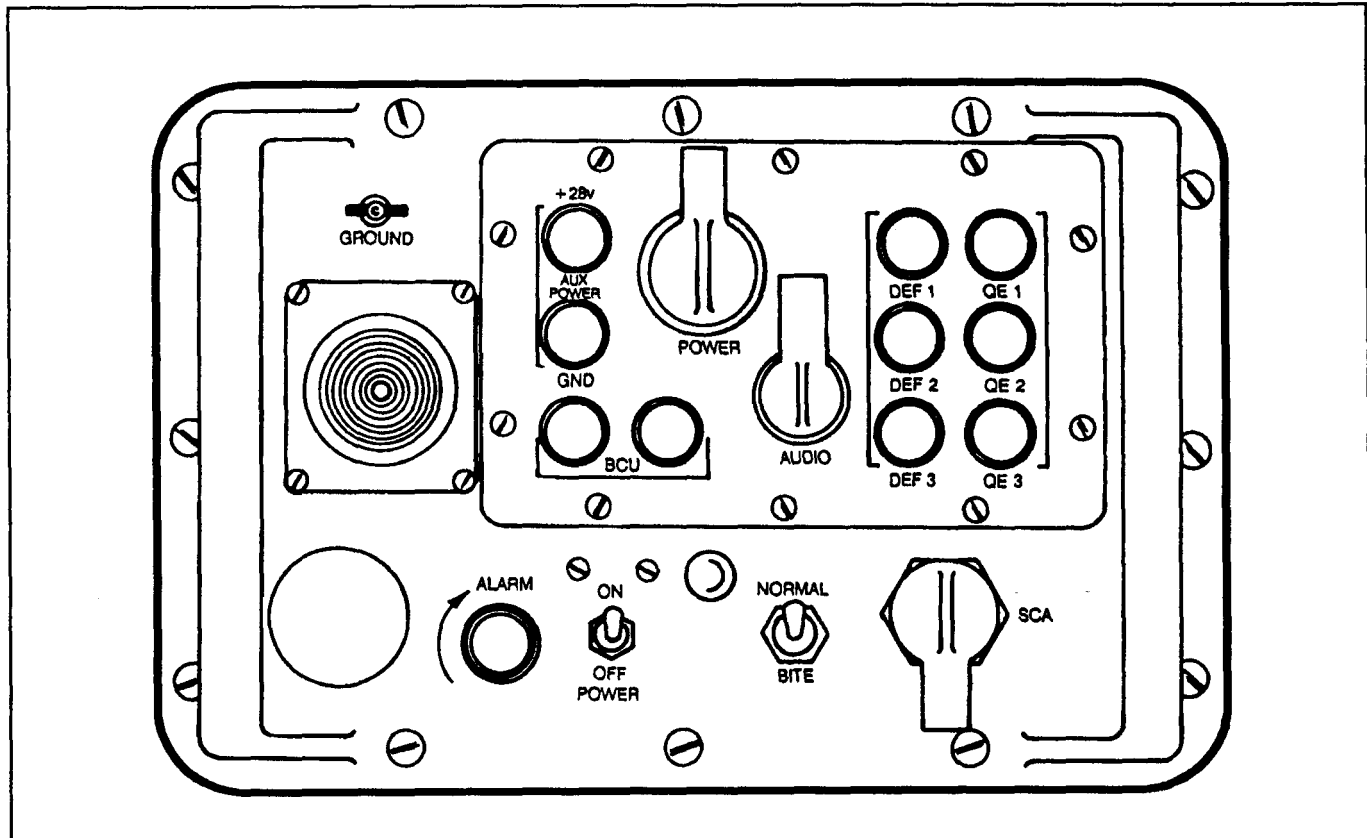

Figure L-4. Case assembly controls, indicators, and connectors

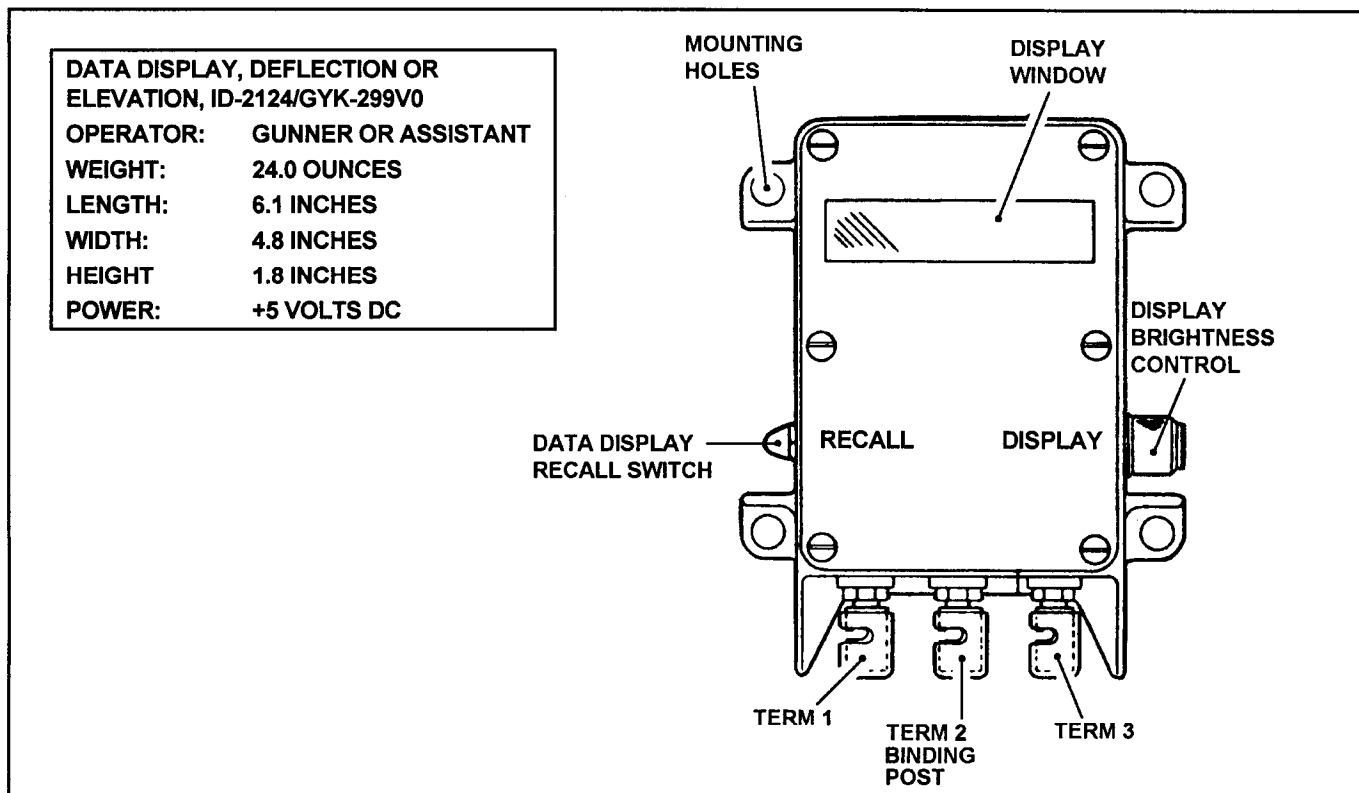

Figure L-5. Gun assembly

(2) The TERM 2 binding post is used to connect field wire between the gun assembly and the ground binding post on the case assembly.

(3) The TERM 3 binding post is used to connect field wire between the gun assembly and the signal binding post on the case assembly.

d. When the RECALL switch is pressed the display reappears. The display normally stays in the display window for 15 seconds. The display also goes blank when the GDU receives EOM, CEASE LOAD, or CHECKFIRE; and it stays blank until data for the next mission is received.

e. The display brightness control is used to vary the brightness of the display window data.

L-5. CABLES

The following cables are provided for connecting the GDU:

- SCA cable(W35) (15 feet long), which provides signal and power connection between the case assembly and the SCA.
- Cable assembly W33 (3 feet long) or W33A (15 feet long), which provides signal connection between the case assembly and the AN/PRC 68 or AN/PRC 126 radios.

- Cable assembly W34 (3 feet long) or W34A (15 feet long), provides power connection between the case assembly and the AN/PRC 68 or AN/PRC 126 radios.

L-6. BCS - GDU WIRE LINK

a. When a unit is not operating with radio, wire is used to connect the GDU to the BCS.

b. The BCS - GDU digital wire link is sensitive and works best with unspliced wire in good condition. A single poor splice or multiple splices will hamper data transmission. Terminal strip TM- 184 should be used when connecting wire in the BCS - GDU link. The MX-155 has not performed well. A good lithium battery (BA-5590) should be installed if a battery is required. Weak or dead batteries may result in lost data, display problems, and nonacknowledged messages.

c. The TA-312 field telephone and/or the AN/GRA-39 should always be used on separate wire lines from the BCS - GDU digital data link. Use of this equipment on the same wire line as the BCS - GDU wire link may hamper communications and damage the GDU. The ring voltage on the TA-312 and the AN/GRA-39 can damage the GDU circuitry.

L-7. WIRE OPERATIONS

The cable and field wire connections discussed below are necessary to apply power to and establish wire communications between the GDU, the chief of section, the gunner, the assistant gunner, and the BCS. Apply GDU power by one of the methods described in paragraph L-9.

Notes:

1. Because of the unique characteristics of a digital wire circuit, its efficiency is seriously impaired by an electrical leakage through the wire insulation or a bad splice. Therefore, great care must be taken in laying the firing battery wire circuits to avoid damage to the insulation. Wire lines must not be laid in water. Splices must be carefully made and well insulated to avoid excessive leakage or possible shorts. Splices on wire lines must be kept to a minimum to reduce line resistance.

2. The use of terminal strip TM-184, instead of jack panel SB-16, is highly recommended. This will reduce circuit resistance due to the internal circuit design of the SB-16.

CAUTION

Ground the GDU to earth ground before starting cabling operations.

a. Operation With Terminal Strip TM-184. Terminal strip TM-184 (Figure L-6) is an expendable Class IX item (NSN 5940-00-238-8493, reference TC 24-20). It is the preferred device to use in connecting wire lines from the GDU to the BCS. If no TM-184 is available in the unit, recommend that the SB-16 be used. The digital wire system connecting the BCS through the TM-184 terminal strip to the GDU is shown in Figures L-6 and L-7.

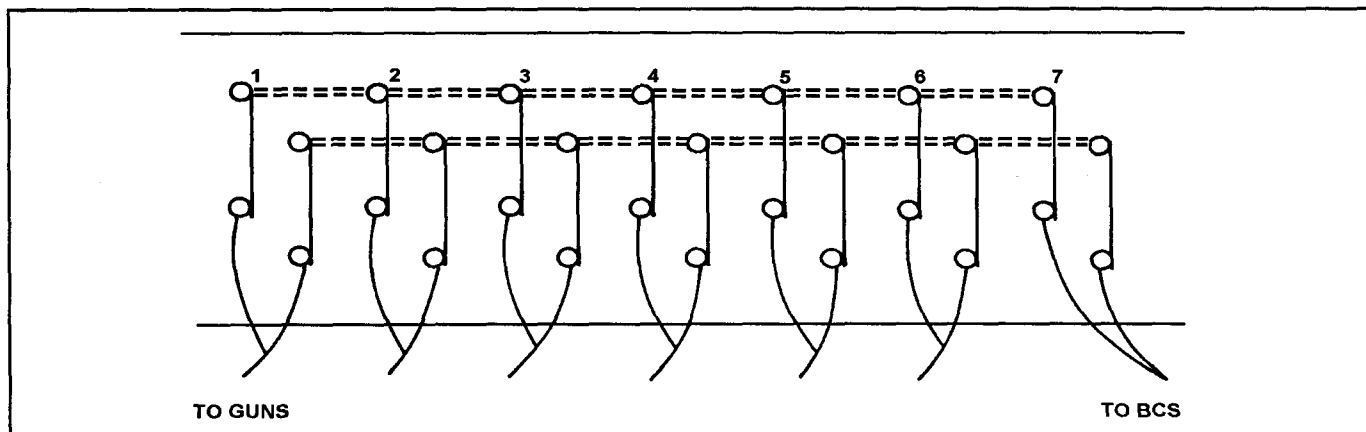

Figure L-6. M-184 terminal strip

b. Wire System Construction. The wire system is constructed by laying a wire line of WD-1/TT field wire between the GDU and the BCS. The modified reel unit RL-39 (A, Figure L-7) is used. Starting at the TM-184 (B, Figure L-7), attach the ends of a WD-1/TT wire (NSN 6145-00-226-8812), (C, Figure L-7) on the strip. Continue laying wire to the gun position, stake it off, and connect the wire to the binding posts labeled BCU (D, Figure L-7) on the GDU. For this connection, prepare both ends of a short piece of WD-1 wire as shown in A of Figure L-8. Connect one end to the connector labeled M-221 on the spool DR-8 (E, Figure L-7) and the other end to the binding posts labeled BCU on the GDU. Using wire from an RL-39 reel, insert the open end in the two binding posts on the TM-184 corresponding to the gun number as shown in F, Figure L-7. Prepare the wire ends according to A, Figure L-8, and ensure that the TM-184 is prepared as shown in Figure L-6. Connect wire circuits for the rest of the guns in the same manner.

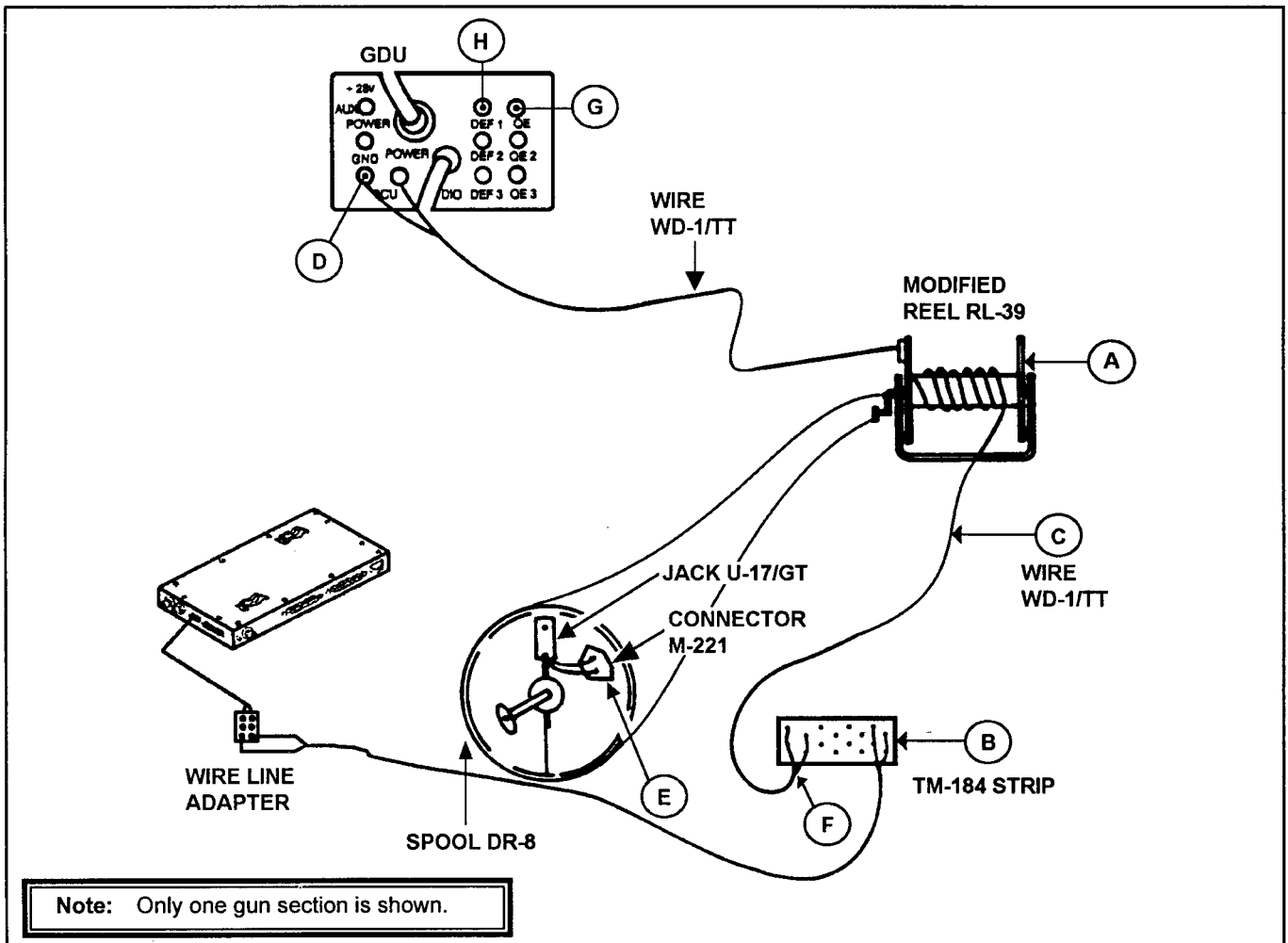

Figure L-7. Connecting the tactical communications interface module and line wire adapter

c. Connector Wire Preparation. Prepare wire for connection as follows.

(1) Cut six pieces of field wire about 25 feet long. Strip about 1/2 inch of insulation from each end (A, Figure L-8), leaving a 1/2 inch strip of insulation on each end of the wire, and twist the two conductors (B, Figure L-8).

(2) Take three pairs of wire. Tag and mark the two ends of each pair QE 1, QE 2, and QE 3 (C, Figure L-8). Connect one end of the pair marked QE 1 to the binding post labeled QE 1 (G, Figure L-7) on the GDU and the other end to the left binding post labeled 1 on the QE gun

assembly. Using the same procedure, connect the other two pairs to the QE 2 and QE 3 binding posts.

(3) Tag and mark the other three cables DEF 1, DEF 2, and DEF 3. Connect one end of the pair marked DEF 1 to the binding post labeled DEF 1 (H, Figure L-7) on the GDU and the other end to the left binding post labeled 1 on the deflection gun assembly. Using the same procedure, connect the other two cables to DEF 2 and DEF 3. Run the GDU self-test to check internal operation. Always use a separate wire line for voice (TA-312 communications). Then make a digital communications check using the BCS;RING and the GDU;RING.

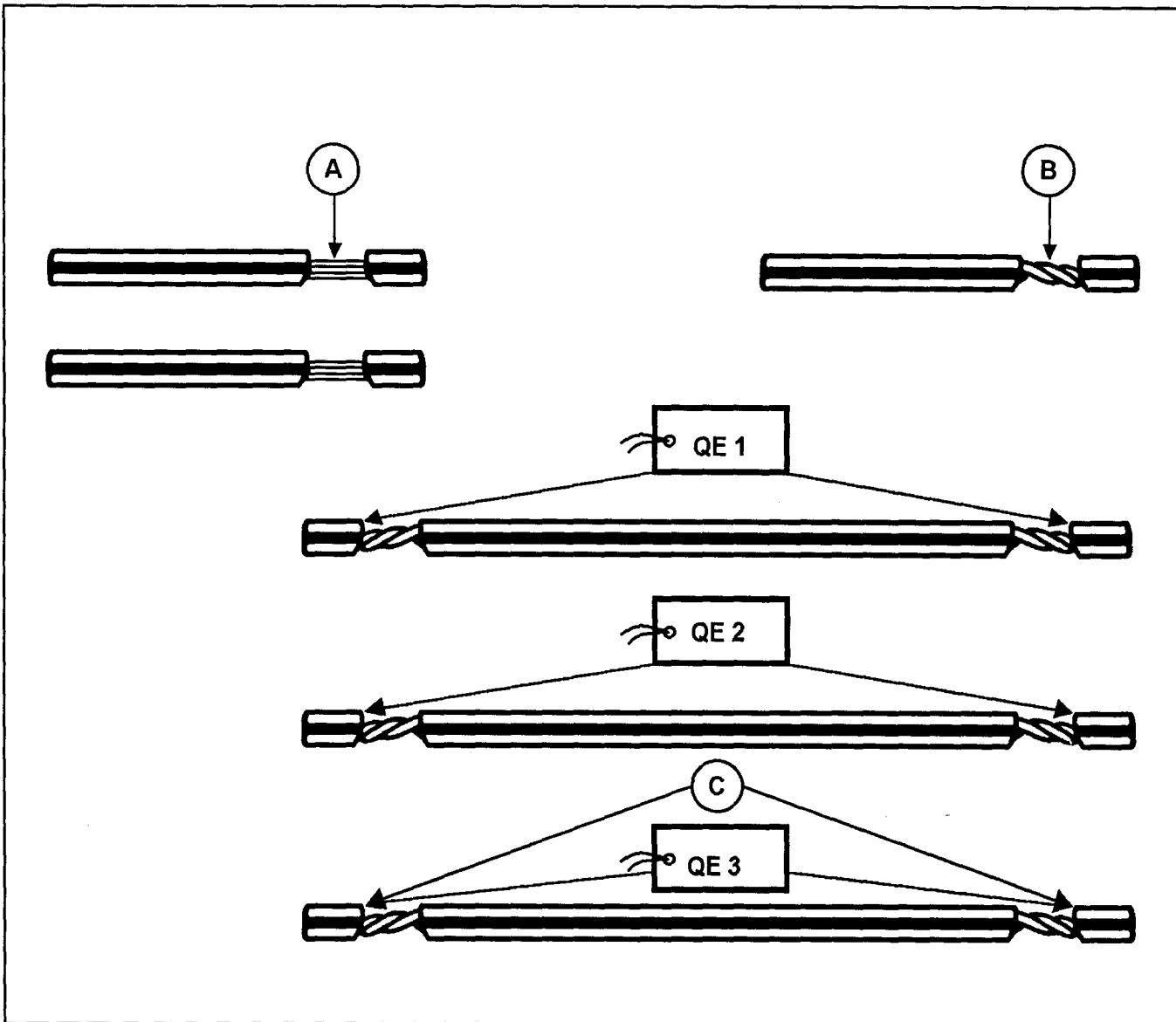

Figure L-8. Preparing wire connector

L-8. M109-SERIES HOWITZERS

The GDU is mounted in the cab of the M109-series of howitzers (Figure L-9). Be sure to leave enough slack in the wire leading outside the cab to the DR-8 to compensate for traversing.

L-9. GUN DISPLAY UNIT POWER

The GDU connected by wire to the BCS can be operated from one of two power sources:

- Internal battery power.
- External power by power cable.

a. **Internal Battery Power (BA-5590).** Install the battery in the case assembly as follows (Figure L-10):

CAUTION

When putting the new battery in the case assembly, handle it very carefully. It is easily damaged by rough handling.

- Loosen the cover fasteners, and remove the cover.
- Put the new battery in the battery compartment, and push the battery in to seat the battery connector with the case assembly connector.

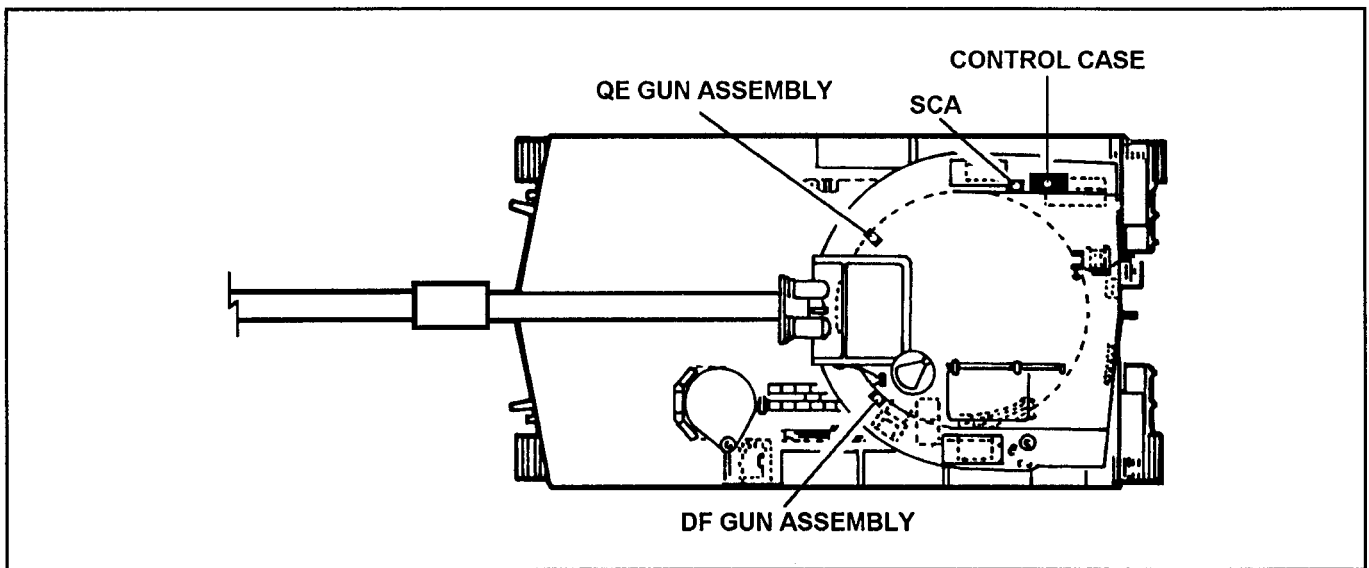

Figure L-9. GDU location on an M109-series howitzer

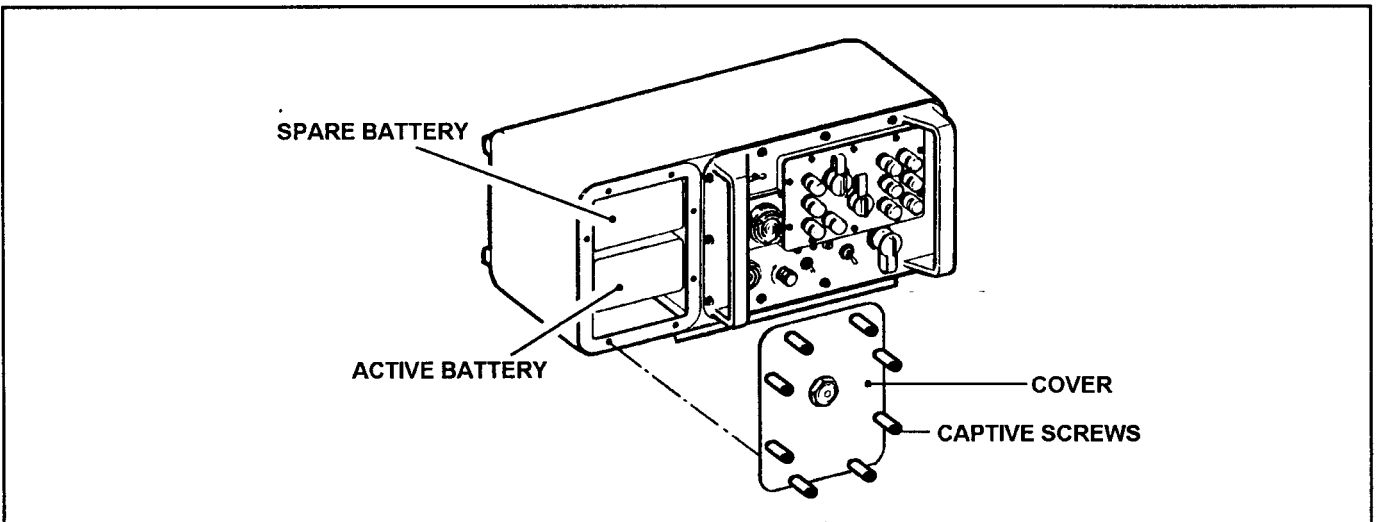

Figure L-10. Battery installation in the case assembly

- Install the spare battery in the battery compartment.
- Put the cover in place, and lock the fasteners.

WARNING

Lithium organic batteries or cells are used in this equipment. They are potentially hazardous if misused or tampered with before, during, or after discharge. The following precautions must be strictly observed to prevent possible injury to personnel or damage to equipment:

- Do not heat, incinerate, crush, puncture, disassemble, or otherwise mutilate the batteries.
- Do not short circuit, recharge, or bypass internal fuse.
- Do not store batteries in equipment during long periods of nonuse (in excess of 30 days).
- Turn off the equipment immediately if you detect that the battery compartment is too hot, hear battery cells venting (hissing sound), or smell irritating sulfur dioxide gas. Remove and dispose of the battery only after it is cool (30 to 60 minutes).

b. External Power (W34 or W34A Power Cable).

(1) Use the W34 cable with the M109-series of self-propelled howitzers and all towed howitzers. Use the W34A cable only on the M110-series self-propelled howitzers.

(2) Install the BA-5590 battery in the case assembly.

Note: Use internal battery power when the W34 (W34A) power cable is connected to the OG-174 AN/VRC. The purpose of the internal battery is to provide backup power whenever external power drops below 12 volts direct current (DC). Power will not be drawn from the internal battery as long as the prime power source voltage is greater than the internal battery voltage.

(3) Remove the dust cap from the power connector of the case assembly.

(4) Join power cable W34 (NSN 7025-01-122-2984) or W34A (NSN 7025-01-122-2985) connector P2 to the power connector on the case assembly.

(5) Connect power cable W34 or W34A connector P1 to the Bendix connector on a 24-volt vehicle power cable.

If you have the AN/PRC 68 or AN/PRC 126 SUT, connect the W34 (W34A) power cable to the OG-174 AN/VRC amplifier power supply group instead of directly to the vehicle power.

L-10. TOWED HOWITZERS

a. The following is a safe, accepted and proven method of remoting power from various vehicles to the GDU when it is used with a towed howitzer. The Communications - Electronics Command (CECOM) Equipment Safety Office agrees that it is a practical solution for the towed howitzer power problem. The required cable can be fabricated locally.

(1) The cable can be built by using the following Class IX parts:

- Connector, plug, electric, NSN 2910-00-567-0128.
- Adapter connector, NSN 5935-00-322-8959.
- Cable, power electric, NSN 6145-00-643-3482.
- Cable, assembly power, NSN 7025-01-122-2984.

(2) The power electric cable comes in 250-foot spools. From these, cables can be cut in varying lengths, according to the needs of the unit. For example, about five 50-foot cables can be made from one spool; so the cost can be divided by five.

(3) The assembly power cable is issued with each GDU but is only 3 feet long, so it has to be modified at no cost to the using unit. The connector plug on one end (the GDU end) is all that needs to be used on this cable.

(4) The total cost of each 50-foot cable will be about \$55.09.

(5) Instructions for fabricating the cable are as follows:

- Remove the connector plug (GDU end) from the GDU power cable, and clean old solder from the connections.
- Cut the new power cable, NSN 6145-00-643-3482, into the required lengths, and strip the insulation from the ends.
- Connect both the black and white wires of the new cable to pin B (+) of the GDU cable connector. Connect the green, or ground, cable to pin A (-) of the same connector. One end of the new cable will be complete.
- Connect the other end of the new cable to connector plug, NSN 2910-00-567-0128. Make sure to observe the same polarity, black and white parallel and attached to the positive terminal and green wire, or ground wire, attached to the negative terminal.

- Use electrical ring (crimp-on) connectors to connect the cable to the terminals on the electric plug connector. Use a short piece of wire or cable (scrap) to fill in the extra hole in the electric plug connector. Finally, seal both holes with RTV (GE silicone caulk).

b. Location of the GDU on various howitzers is shown in Figures L-11 through L-14.

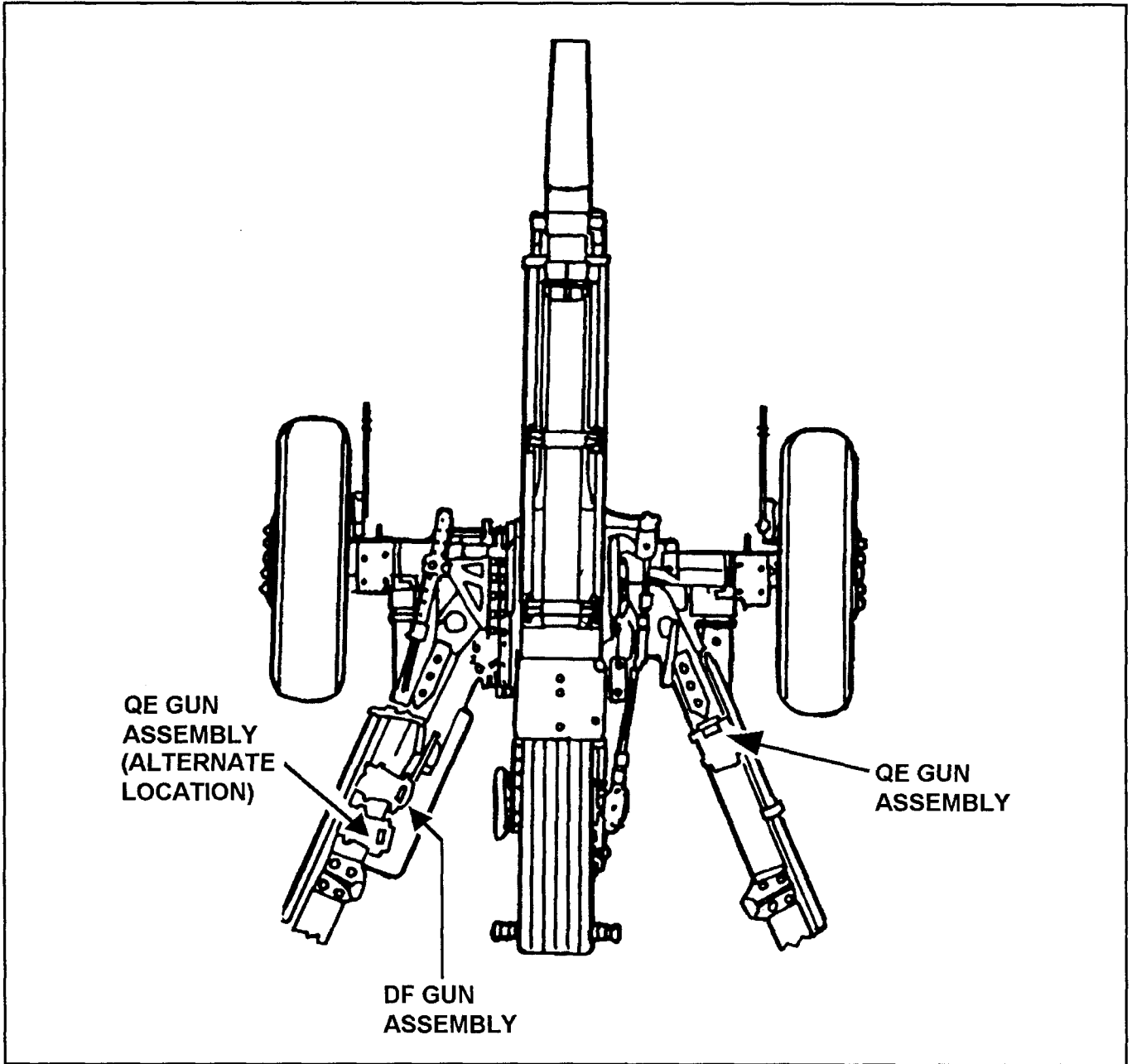

Figure L-11. Gun assemblies on M101A1 105-mm howitzer

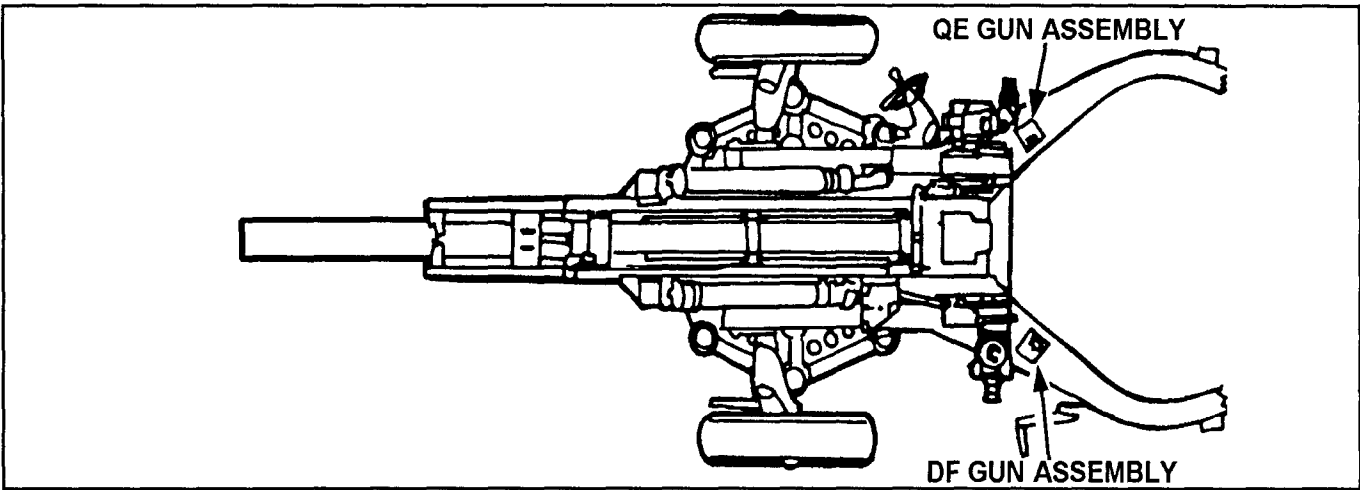

Figure L-12. Gun assemblies on M102 105-mm howitzer

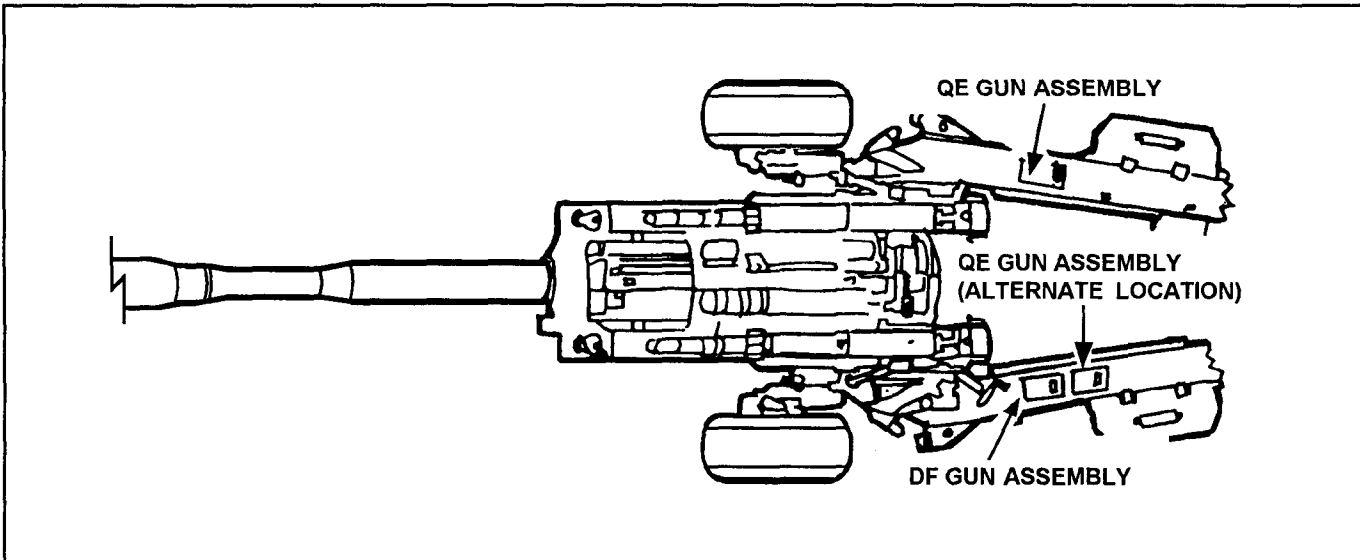

Figure L-13. Gun assemblies on M198 155-mm howitzer

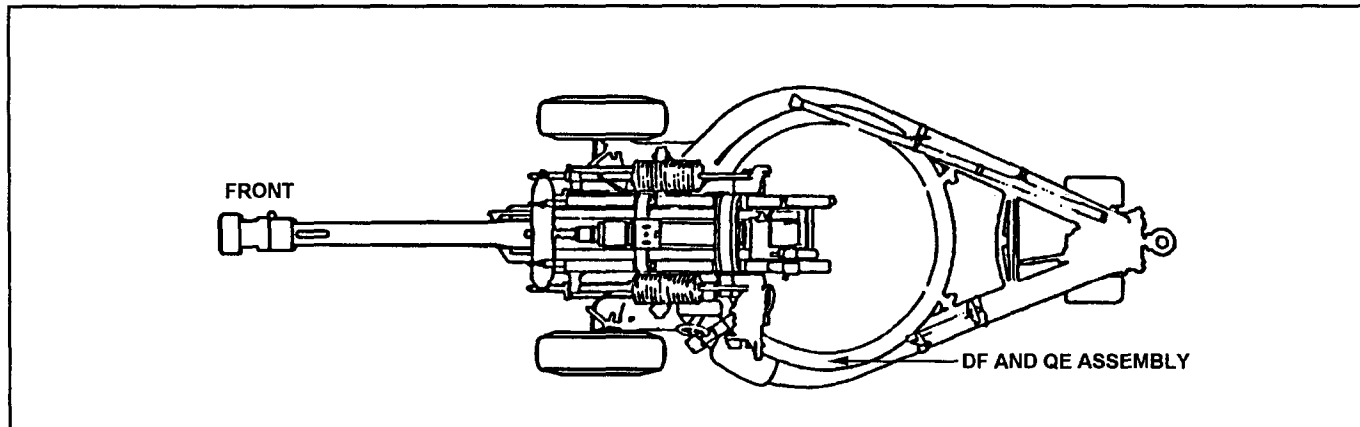

Figure L-14. Gun assemblies on M119A1 105-mm howitzer

L-11. SELF-PROPELLED HOWITZER POWER SOURCE

a. When vehicle power of the SP howitzers is used, firing data can be lost. This can happen when the 5-horsepower electrical motor is started; that is, when the loader rammer is being used, the vehicle is started, or the master switch for the cab is turned on. The result is that all segments of the SCA assembly are lit, causing a wagon wheel effect on the display window. This problem can be solved with the application of a MWO. All new GDUs will have this MWO already applied.

b. Until your GDUs are retrofitted, this problem can be avoided or minimized by announcing the fire commands before operating the loader-rammer.

c. Section chiefs should ensure that a good lithium battery (if available) is in every GDU during operations. Batteries must be changed every 5 to 7 days, depending on the intensity of firing.

d. If firing data are lost, the howitzer section must ensure that-

- Power is recycled on the gun display unit.
- The gun number is reestablished on the section chief's assembly.
- The firing data are retransmitted from the BCS.

L-12. INOPERATIVE GUN DISPLAY UNIT

If the GDU becomes inoperative, it should be turned in for repair. If communications cannot be established with the GDU NORMAL-BITE switch in the NORMAL position, try placing the switch in the BITE position. If this is successful, operation can continue until the GDU can be repaired.

L-13. SMALL UNIT TRANSCEIVERS

The AN/PRC-68 or AN/PRC-126 provide an internal FM voice net. This net will be used for convoy movement, hasty displacements, emergency occupations, and during the initial occupation of a prepared position. Once wire communications are established, radio will no longer be used except for emergency notification of an enemy attack. Despite these radios short planning range, their signal can still be detected by ground and airborne RDF and/or intercept stations. This is another reason wire must be used for internal battery communications as soon as possible after occupation of a position. The radios use the B-A-1588/U battery (NSN 6135-01-094-6536).

a. M577 Vehicle FDC Cabling. The system for the AM-1780 in the FDC is cabled as follows (refer to Figure L-15).

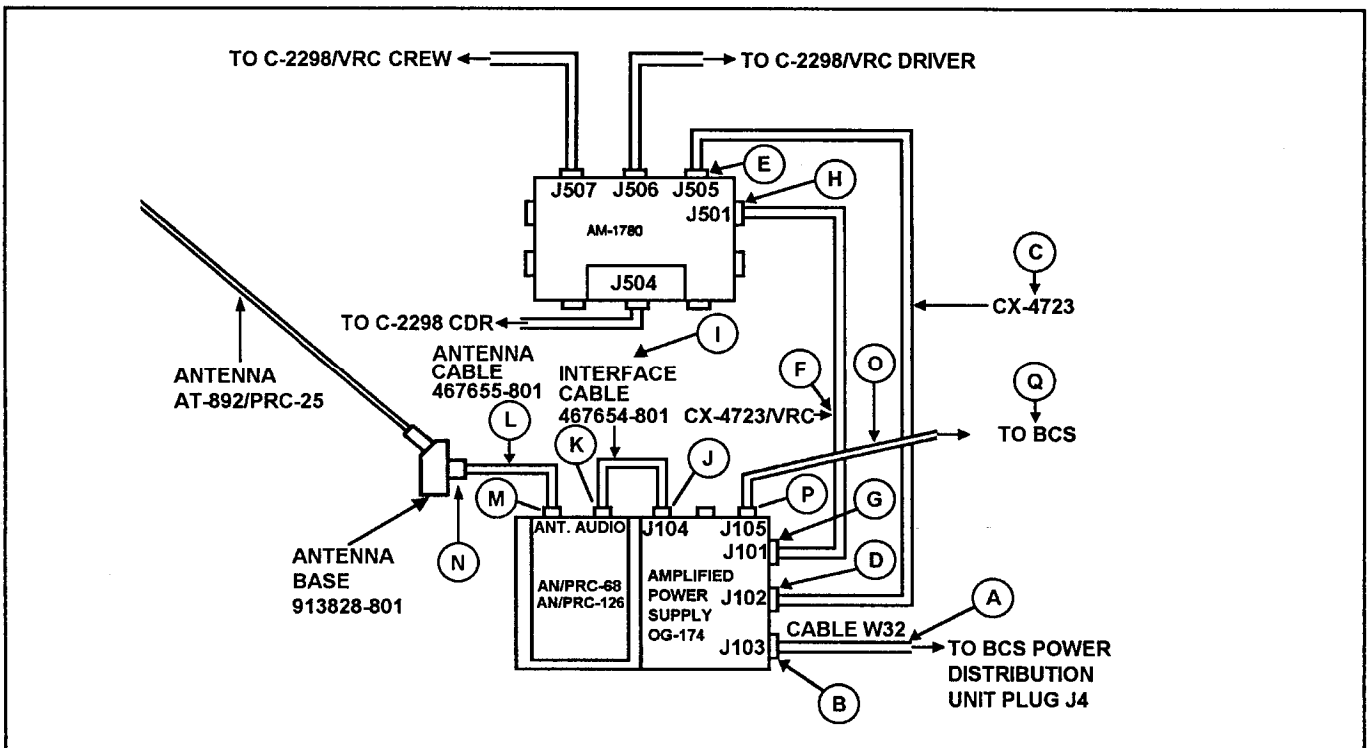

Figure L-15. FDC cabling for the AN/PRC-68 or AN/PRC-126

(1) Connect one end of power cable W32 **A** to the connector labeled J103 **B** on the OG-174 and the other end to the BCS power distribution unit plug J4.

(2) Connect one end of cable CX-4723 **C** to the connector labeled J102 **D** on the OG-174 and the other end to the connector labeled J505 **E** on the AM-1780.

(3) Connect one end of the second cable CX-4723 **F** to the connector labeled J101 **G** on the OG-174 and the other end to the connector labeled J501 **H** on the AM-1780.

(4) Connect one end of the interface cable **I** to the connector labeled J104**J** on the OG-174 and the other end to the connector labeled AUDIO **K** on the AN/PRC 68 or AN/PRC 126.

(5) Connect one end of the antenna cable **L** to the connector labeled ANT **M** on the AN/PRC 68 or AN/PRC 126; connect the other end to the connector **N** on the antenna base.

(6) Connect one end of the data cable **O** to the connector labeled J105 **P** on the OG-174; connect the other end **Q** to the tactical communications interface module of the LCU (see Figure 9-4 and paragraph 9-5 of this publication).

b. Weapon Cabling. Radio sets AN/PRC-68 and AN/PRC-126 are cabled to the weapon as follows (refer to Figure L-16):

(1) Connect one end **A** of cable W33 or W34 **B** to the connector labeled RADIO on the GDU and the other end to the connector labeled GDU **C** on the OG-174.

(2) Connect the interface cable **D** between the OG-174 (J104) **E** and the connector labeled AUDIO **F** on the AN/PRC-68 or AN/PRC-126.

(3) Connect power cable CX-4720 **G** to the vehicle power system (Bendix connector) or the 24-volt DC connector on the OG-174 case assembly.

L-14. PREVENTIVE MAINTENANCE

a. Solder all splices, and wrap them in insulating tape.

b. For WD-1/TT wire, ensure all seven strands are intact at the connections or splices.

c. Ensure all electrical equipment is protected from rain and moisture.

d. Inspect all cables and wires for cuts and rotting.

e. Ensure all connectors are clean with no bent pins or corrosion.

f. Clean the connectors on the GDU, LCU, wire line adapter, TM-184 terminal strip, and M-221 connector with cleaning compound FREON-TF (NSN 6850-00-3084) and a clean cloth.

g. Clean the female end of the connection on the modified reel RL-39 and the holes in the M-221 connector with cleaning compound FREON-TF and a Q-tip.

h. When splicing WD-1/TT wire to cord CX-231, use either a standard field wire splice (TC 24-20) or the expedient method. With either method, be sure to solder and tape the splice.

i. Ensure that personnel do not use solvent to clean the case assembly. This destroys plastic parts inside the pressure relief valve, allowing water to enter.

j. Ensure that personnel do not use high-pressure water hoses on the equipment. The pressure relief valve on the case assembly is designed to open at 3 to 4 pounds of pressure; thus, pressure from the hose will allow water to enter the case assembly.

k. Inspect the case assembly to ensure that there are no missing screws and that all screws are tightened securely.

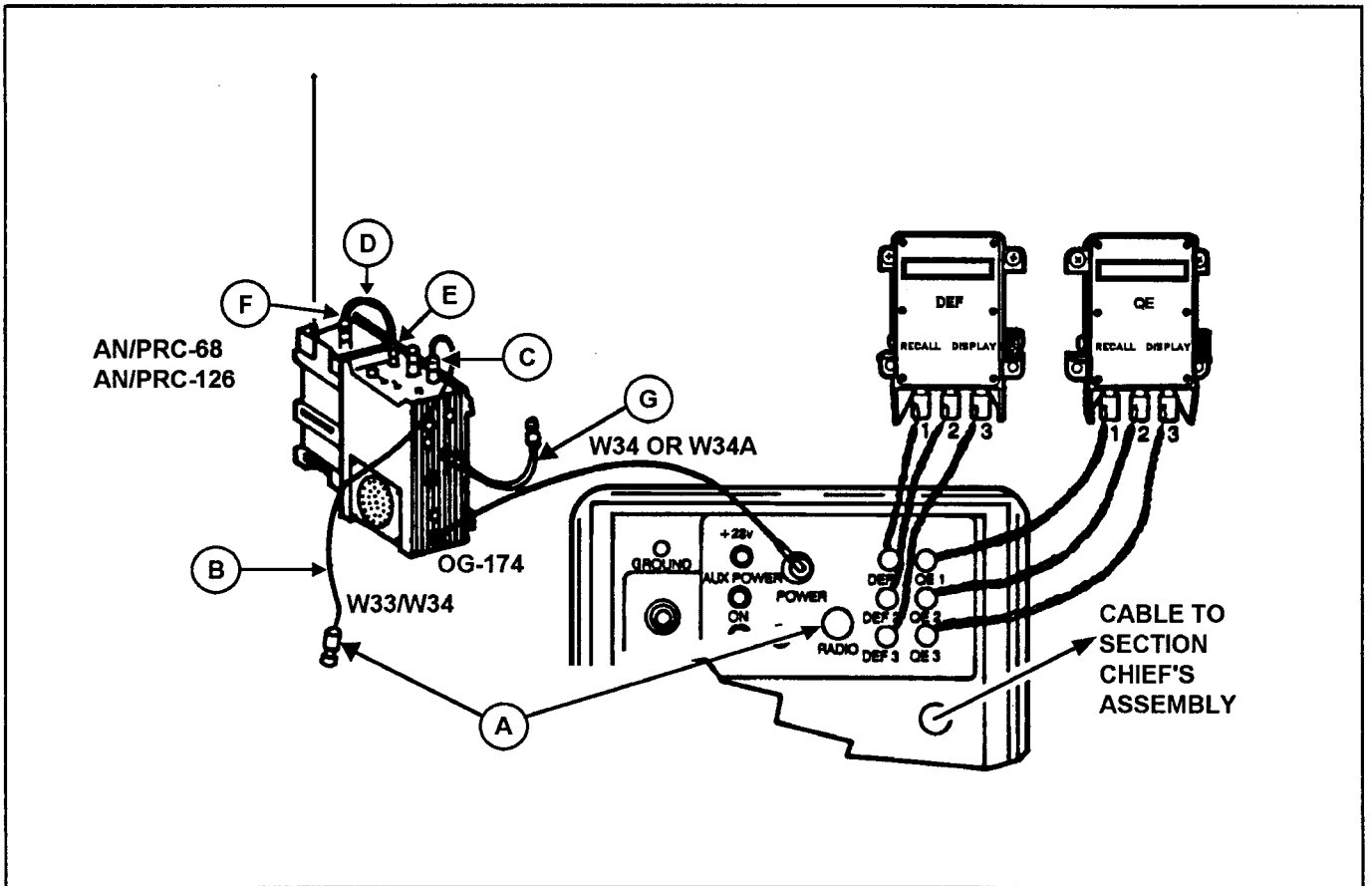

Figure L-16. Gun section cabling for howitzer sections

APPENDIX M
SELECTED CHARACTERISTICS OF FIELD ARTILLERY CANNONS

| | CALIBER AND MODEL | | | | | | |
|--|-----------------------------------|-----------------------------------|---------------------------------|---------------------------------|----------------------------------|--------------------------------|--------------------------------|
| | 105-mm HOW M119A1, TOWED | 105-mm HOW M101A1, TOWED | 105-mm HOW M102, TOWED | 155-mm HOW M198, TOWED | 155-mm HOW M109A2-4, SP | 155-mm HOW M109A5, SP | 105-mm HOW M109A6, SP |
| Maximum Range With RAP (Meters) | 20,100 | 15,100 | 15,300 | 30,100 | 23,500 | 30,000 | 30,100 |
| Maximum Range Without RAP (Meters) | 14,000 | 11,000 | 11,400 | 24,000 | 18,100 | 24,000 | 24,000 |
| Tube Life (EFC Rounds) | 6,500 | M2A1 5,000 M2A2 7,500 | 5,000 | 1,750 | 6,375 | 2,650 | 2,650 |
| Type of Breechblock | VSW | HSW | VSW | TIS | TIS | TIS | TIS |
| Type of Firing Mechanism | SIP | CP M13 | SIP | CP M35 | CP M35 | CP M49 | CP M49 |
| Type of Recoil Mechanism | HPV | HPC | HPV | HPV | HPV | HPV | HPV |
| Minimum Recoil (Inches) (Maximum Charge, High Elevation) | 14.5 | 39 | 30 | 50 | 24 | 24 | 24 |
| Maximum Recoil (Inches) (Maximum Charge, Low Elevation) | 42 | 42 | 50 | 70 | 36 | 36 | 36 |
| Minimum Elevation (Mils) | -100 | -90 | -89 | -75 | -53 | -53 | -53 |
| Maximum Elevation (Mils) | 1,244 | 1,155 | 1,333 | 1,275 | 1,333 | 1,333 | 1,333 |
| Mils per Turn of Handwheel (Elevation) | 20 | 10 | 10 | 10 | 10 | 10 | 10 |
| Type of Traverse | Nut and screw | Pintle | Ball and socket | Pintle | Ring and race | Ring and race | Ring and race |
| Maximum Right Traverse (Mils) | 100 (6,400 speed) | 409 | 6,400 | 400 (6,400 speed) | 6,400 | 6,400 | 6,400 |
| Maximum Left Traverse (Mils) | 100 (6,400 speed) | 400 | 6,400 | 400 (6,400 speed) | 6,400 | 6,400 | 6,400 |

FM 6-50, MCWP 3-1.6.23

| | CALIBER AND MODEL | | | | | | |
|---|--|-----------------------------------|----------------------------------|---------------------------------|----------------------------------|--------------------------------|--------------------------------|
| | 105-mm HOW M119A1, TOWED | 105-mm HOW M101A1, TOWED | 105-mm HOW M102, TOWED | 155-mm HOW M198, TOWED | 155-mm HOW M109A2-4, SP | 155-mm HOW M109A5, SP | 105-mm HOW M109A6, SP |
| Mils per turn of Handwheel (Travers) | 4.5 | 19 | 21 | 10 | 10 | 10 | 5 |
| Type of Trails | Bow shaped | Split | BG | Split | Vehicle spade | Vehicle spade | Vehicle spade |
| Equilibrators | Spring | Spring | Spring | Pneu | HP | HP | HP |
| Panoramic telescope | M137A1 | M12A7S | M113A1 | M137 | M117 | M117A2 | M117/AFCS |
| Telescope mount | M187 | M21A1 | M134A1 | M171 | M146 | M146 | M146 |
| Elbow telescope | M90A2 | M16A1D | M114A1 | M138 | M118CA1 | M118CA1 | none |
| Range or elevation quadrant | M187 | M4A1 | M14A1 | M17/M18 | M15 | M15 | AFCS |
| Approximate operating weight (pounds) | 4,000 | 4,960 | 3,170 | 15,800 | 55,000 (A2) and 53,940 (A3) | 55,000 | 62,960 |
| Length, traveling (feet and inches) | 16' folded | 19' 8" | 21' 10" | 40' 6" | 29' 11" | 30' 11" | 31' 8" |
| Width, traveling (feet and inches) | 5' 10" folded | 7' 6" | 6' 4" | 9' 2" | 10' 4" | 10' 4" | 10' 4" |
| Height, traveling (feet and inches) | 4' 6" folded | 5' 2" | 5' 3" | 9' 6" | 10' 9" | 10' 9" | 11' 1" |
| Time to lay (minutes) (MTP) | 2 | 2 | 2 | 4 | 2 | 2 | :30 |
| Maximum rate of fire (rd/min) (first three minutes) | 6 | 10 | 10 | 4 | 4 | 4 | 4 |
| Sustained rate of fire (rd/min) | 3 | 3 | 3 | 2 | 1 | 1 | 1 |
| Prime mover | Helicopter M1037 Mod | Helicopter 2 1/2-ton truck | Helicopter 2 1/2-ton truck HMMVV | 5-ton truck | SP | SP | SP |
| Technical manual | 9-1015-252-10 | 9-1015-203-12 | 9-1015-234-10 | 9-1025-211-10 | 9-2350-311-10 | 9-2350-311-10 | 9-2350-314-10 |
| LEGEND: | AFCS = automatic fire control system BG = box grider CP = continuous pull HP = hydropneumatic HPC = hydropneumatic constant HPV = hydropneumatic variable HSW = horizontal sliding wedge PH = percussion hammer pneu = pneumatic SIP = spring-actuated, inertia percussion TIS = thread, interrupted screw VSW = vertical sliding wedge | | | | | | |

APPENDIX N
INTERCHANGEABILITY OF AMMUNITION

N-1. GENERAL

Ammunition interoperability between the US Army and its allies is important. The purpose of this appendix is to show the field artillery ammunition components that are authorized and/or acceptable for exchange between the US and various allies during training and combat conditions. This has been done through the use of tables. Countries for which data are currently available are: Belgium, Canada, Denmark, France, Germany, Italy, Netherlands, Norway, Turkey, United Kingdom, Greece, Portugal, Spain, and United States.

N-2. TRAINING

Tables N-1 and N-2 reflect the cartridge-propellant charge combinations that are authorized for firing by US troops in training. Tables N-1, N-2 and N-3, page N-2, describe complete round combinations authorized for exchange by a memorandum of agreement signed by each nation. A mix of components of other nations is not authorized for use by the US. For example, a German projectile cannot be used with a Canadian propellant charge for training.

Note: The following charts cover only authorized items for NATO countries and US use. If a munitions item has not been authorized, it is because it has not yet been determined to be safe to fire or it has been determined that the munitions items cannot be safely fired from the US weapon systems.

Table N-1. Cartridge-propellant charge authorized for use by the US in training (105-mm howitzers)

| CALIBER | US | GREECE | SPAIN |
|---------|------------------|------------------|------------------|
| 105-mm | M1 Charge M67 | M1 Charge M67 | M1 Charge M67 |

N-3. COMBAT

Ammunition combinations acceptable for exchange only during combat are described in the appropriate STANAG and the Land Forces ammunition Interchangeability Catalogue (Short Title-Allied Ordnance Publication [AOP]-6). Table N-3 describes the cartridge and fuze combinations acceptable for exchange in combat for 105-mm howitzers. Tables N-4, page N-3, and N-5 page N-4, show the projectile and propellant charges acceptable for exchange in combat for 155-mm howitzers. When Tables N-3, N-4, and N-5 are used in conjunction with Table N-7, page N-5, complete round combinations which can be exchanged in combat can be determined.

CAUTION
 Do not mix ammunition components of one nation with those of another. Additionally components in Tables N-3 through N-7 are to be exchanged only in combat.

Table N-2. Fuzes permitted by US for firing in training (155-mm)

| TYPE | US | BE | CA | FR | GE | GR | IT | NL | NO | PO | SP | TU | UK |
|-----------|-----------------------------------|--------------|--------------|--------------|-------|------|----------------|------|--------------|--------------|------|--------------|--------------------------|
| PD | M557 M739 M572 ¹ | M557 M739 | M557 M739 | M557 M739 | DM241 | M557 | M557 M739 | M557 | M557 M739 | ² | M557 | ² | M557/ L85A2 L112A1 |
| MT | M565 | | | | DM241 | | | | | | | ² | |
| MTSQ | M564 M582 M577 | M564 M582 | | | | M564 | M564 M520A1 | | | | | | |
| ET | M762 M767 | | | | | | | | | | | | |
| Proximity | M732 | | M732 | | | | | | | | | | |

¹203-mm only
²Pending agreement for training

Table N-3. Cartridges/fuzes permitted by the US for firing in combat (105-mm)

| CART-RIDGE/FUZE | US | BE | CA | DA | FR | GR | IT | NO | PO | SP | TU |
|---------------------------------------|---|--|--|-------------------------------|------------------------------|--|--|-------------------------|------------------------|----------------------|---|
| HE/MTSQ ET | M1/ M564 M582 M767 | M1/ M500S M520A1 | M1/ M520A1 | M1/ M500 | M1/ M500 | M1/ M500S M520A1 M5564 | M1/ M500S M520 | M1/ M500S M520S | DM21 DM131 | M1/ M564 | M1/ M500S M520 DM113 |
| HE/PD | M1/ M557 M739 | M1/ M5A15 M577 M739 | M1/ M577 M739 | M1/ M51A5 M557 M739 | M1/ M51A5 M577 M739 | M1/ M48A2 M57A4 M51A5 M577 | M1/ M51A5 M557 M739 | M1/ M51A5 | DM21/ M51A5 M577 | M1/ M567 | M1/ M51A5 M557 M739 DM211 |
| Illum/ MT MTSQ ET | M314 M501S M314A3 M565 M577 M762 | M314A1/ M501S M314S/ M565 M577 | M314S/ M565 M577 | M314S/ M565 M577 | M314S/ M501 | M314SA M501S M565 | M314S/ M501S M314S M565 M577 | M314S/ M501S | | M314A3/ M565 | |
| Smoke HC/MT MTSQ ET | M84S/ M501S M565 M577 M762 | M84/ M501S | M84S/ M501A1 | M84S/ M501A1 | | M84S/ M50S | M84S/ M501S | M84B1/ M501A1 M54 | | | M84 / M501S |
| Smoke Green BE/MT MTSQ ET | M84/ M501 M84B1/ M501A1 M84S/ M565 M577 M762 | | M84S/ M501A1 | | | | M84S/ M501S | M84B1/ M501 | M84S/ M501S | | |
| Smoke Red/MT MTSQ ET | M84S/ M501S M565 M577 M762 | | M84S/ M501A1 | | | | M84/ M501S | | | | |
| Smoke WP/PD MTSQ | M60A1/ M557 M739 M60A2 M739 | M60/ M51A5 M557 M739 | M60/ M557 M60A2/ M557 M739 | M60/ M51A5 M577 M739 | M60/ M51A5 | M60/ M51A5 M577 | M60S/ M51A5 M577 M739 | M60/ M51A5 M51A4 | M60/ M577 | M60/ M557 M564 | M60/ DM211 M51A5 M51A4 M557 M739 |

LEGEND:

MOFA = multiple option fuze artillery
S = series

Notes:

1. Weapons are M101, M101A1, M102, and M119A1.
2. All listed cartridges are issued fuzed. Rounds should be fired with the issued fuze.
3. The XM773 MOFA fuze is projected to replace the following current fuzes beginning in FY94: M564, M582, M557, M739, M739A1, M513, M514, M728, M732, M587.
4. The M762 and M767 fuzes are projected to replace the M577.
5. The M78 and M78A1 CP are not safety-certified for peacetime use.
6. The MK 399MOD1 will replace the M78A1 series fuzes.

Table N-4. Projectiles/propellant charges permitted by the US for firing in combat (155-mm)

| TYPE | US | BE | CA | DA | FR | GE | GR | IT | NL | NO | PO | SP | TU | UK |
|-------|--|--------------------------|-----------------------------------|--------------------------------|---------------|---|----------------------------------|---|---|-----------------------|-----------------|-----------------|-----------------|-----------------------|
| HE | M107/ M3 M3A1 | M107/ M3 | M107/ M3 M3A1 | M107/ M3 M3A1 | | DM21/ DM62 | M107/ M3 M3A | M107/ M3 M3A1 DM62 | M107C1 M107B2 M107/ M3C1 M3C2 | NM28 M107/ M3 | M107/ M3A1 | M107/ M3A1 | M107/ M3 | M107/ M3 M3A1 |
| | M107/ M4A2 | M107/ M4A1 | M107/ M4A1 M4A2 | M107/ M4A1 M4A2 | | DM21/ DM42B1 | M107/ M4 M4A1 | M107/ M4A1 M4A2 DM72 | M107C1 M107B2 M107/ M4A1 M4C3 | NM28 M107/ NM23 | M107/ M4A2 | M107/ M4A2 | M107/ M4A2 | M107/ M4A1 M4A2 |
| WP | M110/ M3 M3A1 | M110/ M3 | M110/ M3 M3A1 | M110/ M3 M3A1 | | | M110/ M3 M3A1 | M110/ M3 M3A1 DM62 | M110/ M3C1 M3C2 | M110/ M3 | | M110/ M3A1 | M110/ M3 | M110/ M3 M3A1 |
| | M110/ M4A1 M4A2 | M110/ M4A1 | M110/ M4A1 M4A2 | M110/ M4A1 | | | M110/ M4 M4A1 | M110/ DM42 M4A1 M4A2 | M110/ M4A1 M4C3 | M110/ NM23 | | M110/ M4A2 | M110/ M4A1 | M110/ M4A1 M4A2 |
| Smoke | M116B1/ E1, M116/ M3 M3A1 | M116/ M116B1/ M4A1 | M116B1/ M116/ M4A1 M4A2 | M116E1/ M3 M3A1 | | DM25A1 DM25 DM35 DM45/ DM62 | M116 M116E1/ M3 M3A1 | M116/ M3 M3A1 | M116C1/ M4A1 M4C3 M43C2 | M116/ NM23 | M116A1/ M4A1 | | M116/ M3 | M116/ M3 |
| | M116B1/ E1 M116 M4A1 M4A2 | M116 M116B1/ M4A1 | M116B1/ M116/ M4A1 M4A2 | M116E1 E1, M116/ M4A1 | | DM25A1 DM25/ DM42B1 | M116 M116B1/ M4A1 M4A2 | M116/ M4A1 M4A2 DM42 | M116C1 M4A1 M4C3 M43C2 | M116/ NM23 | M116A1/ M4A1 | | M116/ M4A1 | M116/ M4A1 |
| Illum | M48A1/ E1 M485/ M3 M3A1 | M485A2/ M3 | M485A2 M485A1/ M3 M3A1 | M485A2/ M3 M3A1 | | DM16A1 DM26/ DM62 | M485E2 M485A2 M3 M3A1 | M118A2/ M3A1 DM62 | NR109/ M34 | | M485A2/ M3A1 | M485A2/ M3A1 | M485A2/ M3A1 | M485A2/ M3A1 |
| | M485A1/ E1 M485/ M4A1 M4A2 | M485A2/ M4A1 | M485A2 M485A1/ M4A1 M4A2 | M485A2/ M4A1 | M118/ M4A1 | DM16A1 DM26/ DM42B1 | M485E2 M485A2 M4A1 M4A2 | M118A2 M485A2/ M4A1 M4A2 DM42 | NR109/ M4A1 M4C3 | | M45A2/ M4A2 | M485A2/ M4A2 | M118/ M4A1 | M485A2/ M4A2 |

Notes:

1. Currently the US, Belgium, and Canada have the M119A2 charge and fire it with the M110A1, M107, M116, and the M485A2 projectiles. The Dutch (NL) have NR13, which is similar to the M119A2.
2. Germany has the M549A1 HE RAP and is using both the M4A2 and the M119A1 charges (see Table N-5).
3. DM45 smoke and DM62 illum can be fired with mixed DM52 charge (78).
4. M485 illum is restricted to firing Zones 1 through 6.

Table N-5. New projectile/propellant charges permitted by the US for firing in combat (155-mm)

| TYPE | US | BE | CA | GE | GR | IT | NL | UK |
|-------------|---|---------------------------------|-----------------|---|--|---|-------------------------------|---|
| DPICM | M483A1/ M3A1 M4A2 M119A2 | M483A1/ M3 M4A1 M119A2 | | M483A1/ DM62 DM49B1 DM52 L8A1 | | | M483/ M3C1 M4C3 NR13 | |
| HE RAP | M549A1/ M4A2 ¹ M119A2 M203 ² | | | | M549A1/ M4A2 ¹ M119A1 | | | |
| HE | | | XC10/ M119A2 | L15A1 ³ / L2A1 L8A1 L10A1 | | L15A1 ³ / L2A1 L8A1 L10A1 | | L15A1 ³ / L2A1 L8A1 L10A1 |
| Smoke WP | M825/ M3A1 M4A1 M119A2 M203 ³ | | | DM105 ³ / L2A1 L8A1 L10A1 | | DM105 ³ / L2A1 L8A1 L10A1 | | DM105 ³ / L2A1 L8A1 L10A1 |
| illum | | | | DM106 ³ / L2A1 L8A1 L10A1 | | DM106 ³ / L2A1 L8A1 L10A1 | | DM106 ³ / L2A1 L8A1 L10A1 |

¹ Fired rocket on, Zone 7 only.
² Fired in M199 and M284 cannon tubes only.
³ Fired in FH70 only.

| TYPE | US | BE | CA | DA | FR | GE | GR | IT | NL | NO | PO | SP | TU | UK |
|-------------------|-------------------------------------|-----------------------|-----------------------------|----------------|------|----------------|------|-----------------------------|--|-----------------|------|-----------------------------|-----------------------|---|
| PD | M577 M739 | M577 M739 M51A5 | M557 M739 | M557 M51A5 | M577 | DM241 DM211 | | M577 M535 M572 | M577 M557C1 M572 M572C1 M572C2 | M557 DM211 | | | M51A5 M557 M572 | M572 M557 L85A2 L112A1 L32A2 L32A3 |
| CP ¹ | M78A1 MK399 Mod 1 | M78 M78A1 | M78 M78A1 | | | DM71 DM71B1 | M78 | M78 M76A1 | M572 M572C1 M572C2 | | | | | |
| Prox- imity | M514A1 ² M72B M732 | | M514A1 ² M732 | | | | | M514A1 ² M732 | | NUT42 | M732 | M514A1 ² M72B | | L78 |
| MTSQ ³ | M501 M501A1 | M501A1 | M501A1 | M501 M501A1 | | DM53 | | M501A1 | | M501 M501A1 | | | M561 M501A1 | L81A2 |
| MTSQ | | M520A1 | M520A1 | M520A1 | | | | M520A1 | | M520A1 DM113 | | | M520A1 | M520 |
| MT ⁴ | M565 | M565 | M565 | M565 | | | | M565 | NR150 | | | | | L92 |
| MTSQ ⁵ | M564 M582 | M564 | M564 M582 | M564 | | | M564 | M564 | | | | | M564 | |
| MTSQ ⁶ | M577 | M577 | M577 | | | | | | M572 | | | | | |

¹ M78 and M78A1 are not safety-certified for peacetime use (combat only). Navy fuze MK399 Mod 1 is a CP-type fuze but is sensitive to heavy rainfall.
² Requires the removal of the supplementary charge (if one is present).
³ 155-mm M116 (HC, smoke) only.
⁴ 155-mm M449 (HE, ICM), M485 (illum), and M116A1 (HC, smoke) only.
⁵ 155-mm M1 (HE), M107 (HE), M110 (VP), and M110 (HD, gas) only.
⁶ 155-mm M449 (HE, ICM), M483 (HE, DPICM), M692/M731 (ADAM), M718/M741 (RAAMS), M485 (illum), and M116A1 (smoke) only.

Table N-7. Fuzes Permitted by the US for Firing in Combat (155 mm and 203 mm)

| TYPE | US | BE | CA | DA | FR | GE | GR | IT | NL | NO | PO | SP | TU | UK |
|-------------------|-------------------------------------|-----------------------|-----------------------------|----------------|------|----------------|------|-----------------------------|--|-----------------|------|-----------------------------|-----------------------|---|
| PD | M557 M739 M572 ¹ | M557 M739 M51A5 | M557 M739 | M557 M51A5 | M557 | DM241 DM211 | | M557 M535 M572 | M557 M557C1 M572 M572C1 M572C2 | M557 DM211 | | | M51A5 M557 M572 | M572 M557 L85A2 L112A1 L32A2 L32A3 |
| CP ² | M78A1 MK399 Mod 1 | M78 M78A1 | M78 M78A1 | | | DM71 DM71B1 | M78 | M78 M76A1 | M572 M572C1 M572C2 | | | | | |
| Prox- imity | M514A1 ³ M72B M732 | | M514A1 ³ M732 | | | | | M514A1 ³ M732 | | NUT42 | M732 | M514A1 ³ M72B | | L78 |
| MTSQ ⁴ | M501 M501A1 | M501A1 | M501A1 | M501 M501A1 | | DM53 | | M501A1 | | M501 M501A1 | | | M561 M501A1 | L81A2 |
| MTSQ | | M520A1 | M520A1 | M520A1 | | | | M520A1 | | M520A1 DM113 | | | M520A1 | M520 |
| MT ⁵ | M565 | M565 | M565 | M565 | | | | M565 | NR150 | | | | | L92 |
| MTSQ ⁶ | M564 M582 | M564 | M564 M582 | M564 | | | M564 | M564 | | | | | M564 | |
| MTSQ ⁷ | M577 | M577 | M577 | | | | | | M572 | | | | | |

¹203 mm only.

²M78 and M78A1 are not safety-certified for peacetime use (combat only). Navy fuze MK399 Mod 1 is a CP-type fuze but is sensitive to heavy rainfall.

³Requires the removal of the supplementary charge (if one is present).

⁴155 mm—M116 (HC, smoke) only.

⁵155 mm—M449 (HE, ICM), M485 (illum), and M116A1 (HC, smoke) only.

⁶155 mm—M1 (HE), M107 (HE), M110 (WP), and M110 (HD, gas) only; 203-mm - M106 (HE) only.

⁷155 mm—M449 (HE, ICM), M483 (HE, DPICM), M692/M731 (ADAM), M718/M741 (RAAMS), M485 (illum), and M116A1 (smoke) only; 203 mm—M404 (HE, ICM) and M509 (HE, DPICM) only.

APPENDIX O
SAMPLE TESTS AND REPORTS

O-1. SAMPLE TESTS FOR THE QUALIFICATION OF SAFETY PERSONNEL

a. Description. The qualification tests presented here are designed to be used by the commander as a guide in developing a program that fully qualifies all personnel involved in firing. The commander may use these tests, modified as required to meet local requirements, to determine the level and knowledge of selected personnel concerning safety regulations and procedures. Also, he may use them to determine specific areas that require refresher or remedial training.

b. Format. Qualification Test I is designed for those personnel not ordinarily tasked to compute safety data; for example, the howitzer section chief, platoon sergeant, and gunnery sergeant. Test II is designed for all officers and any other personnel who may be responsible for the computation of safety data. At the discretion of the examiner, Test I may also be given with Test II.

c. Test Administration.

(1) Examinees should be allowed about 1 week to prepare for the examination. During this period, they should have access to the following references:

- AR 385-63.
- FM 6-40.
- FM 6-50.
- TM 43-0001-28.
- Local range regulations, SOPs, and any other local publications pertaining to safety.
- Weapon technical and field manuals.

(2) The following should be provided by the examiner for use by the examinee for Test II, part 4, only:

- Applicable tabular and graphical firing tables.
- Graphical site table.
- AR 385-63.
- FM 6-50.
- One copy of local range regulations.

d. Grading. Table O-1 presents a recommended method of weighing this examination. Test I is valued at 55 raw points. Tests I and II together are valued at 196 raw points.

Table O-1. Recommended grading procedure

| PART | CUTS PER PROBLEM | TOTAL WEIGHT |
|--|------------------|--------------|
| Qualification Test I | | |
| 1. True and false | 1 point each | 15 |
| 2. Multiple choice | 2 points each | 20 |
| 3. Completion | 2 points each | 20 |
| Qualification Test II | | |
| 1. True and false | 1 point each | 10 |
| 2. Multiple choice | 2 points each | 6 |
| 3. Completion | 2 points each | 20 |
| 4. Performance: 24 | | 15 |
| 25 | | 25 |
| 26 | | 25 |
| 27 | | 20 |
| 28 | | 10 |
| 29 | | 10 |
| Note: Mathematical errors and expression errors should be assessed a cut of 1 point each. | | |

QUALIFICATION TEST I

Part 1: True and False

1. _____ Each section chief must be informed of the minimum and maximum quadrants and the left and right deflection limits.
2. _____ It is safe to fire a projectile without a fuze.
3. _____ In direct fire, the chief of section must ensure that minimum elevation limits are not violated.
4. _____ During heavy rain, the M557 fuze should not be fired.
5. _____ The chief of section will verify the serviceability of ammunition.
6. _____ Chemical and high-explosive projectiles can be stored together.

7. _____ Projectiles (and fuzes) that have been removed from a cannon by means of extraction should be fired on the next mission.

8. _____ Time fuzes previously set but not fired must be reset to safe.

9. _____ If the left deflection limit is 3,650 mils, it is safe to fire a round at deflection 3700.

10. _____ The maximum and minimum quadrants do not change even if the charge or type of ammunition changes.

11. _____ When the firing point changes, so does the safety diagram.

12. _____ Once a howitzer is initially laid for direction with the aiming circle, it should never be traversed before the primary aiming point is emplaced.

13. _____ A registration will cause the deflection limits, minimum time, and maximum and minimum quadrants of the safety diagram to change.

14. _____ Before firing a round, the chief of section must ensure that the correct number and types of remaining charge increments are held up at the rear of the piece.

15. _____ The chief of section has final responsibility for the safety of the crew and the settings on his weapon before the command to **FIRE**.

Part 2: Multiple Choice

16. Who is responsible for ensuring that the proper time is set on a fuze before a round is loaded into a howitzer?

- a. platoon sergeant
- b. platoon leader
- c. number 1 cannoneer
- d. section chief

17. Who are the individuals specifically responsible for safety in service practice?

- a. range officer, OIC, safety officer, chief of section, and fire direction officer
- b. platoon leader, safety officer, and battery commander
- c. platoon leader, safety officer, unit commander, and chief of section
- d. platoon leader, platoon sergeant, and safety officer

18. What is the proper fuze setting to cause the M564 MTSQ fuze made in 1969 to function on impact?

- a. 90.0 seconds
- b. Safe
- c. 100.0
- d. PD

19. When the end-for-end test of the gunner's quadrant (M1 or M1A1) is performed, the maximum allowable error is plus or minus-

- a. 4 mils.
- b. 1 mil.
- c. 1 mil.
- d. 0.1 mil.

20. The proper command for verifying the lay of number 1 howitzer is-

- a. **NUMBER 1, REFER AIMING POINT THIS INSTRUMENT.**
- b. **NUMBER 1, REFERRED DEFLECTION THIS INSTRUMENT.**
- c. **NUMBER 1, ADJUST.**
- d. **NUMBER 1, ADJUST, AIMING POINT THIS INSTRUMENT.**

21. Ammunition will NOT be fired if-

- a. it is over 6 months old.
- b. the lot number is not known.
- c. it is more than 1 year old.

22. Which of the following best describes the use of a safety diagram?

- a. to check the fire commands against right and left deflection limits only
- b. to compare announced fire commands against the safety limit data
- c. to graphically check the impact area against the range limits
- d. to compare the announced fire commands with the minimum range limits

23. Which of the following constitutes an unsafe act?
- a. failure to swab the powder chamber after each round of separate loading ammunition
 - b. failure of the chief of section to announce **ON THE WAY**
 - c. failure of the gunner to announce **READY**
24. Who is authorized to announce **CHECK FIRING**?
- a. platoon leader only
 - b. safety officer only
 - c. chief of section or gunnery sergeant only
 - d. anyone noticing an unsafe condition
25. How long may a round remain chambered in a hot tube before it should be fired or removed from the weapon?
- a. 1 minute
 - b. 2 minutes
 - c. 5 minutes
 - d. 10 minutes

Part 3: Completion

26. How are white phosphorus projectiles stored? Explain why.

27. If a VT fuze does not seat properly in the fuze well, what actions should be taken?

28. Describe the method for placing out safety aids.

29. Which of the following diagrams illustrate correct sight pictures? Indicate your answer by placing an X in the appropriate spaces provided below.

- a. (1)_(2)_(3)_
- b. (1)_(2)_(3)_(4)_

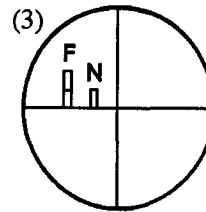
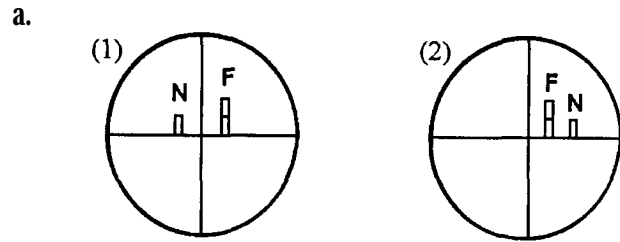

b.

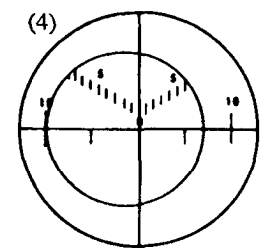
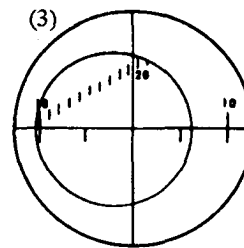
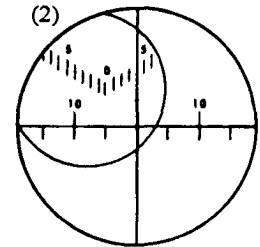
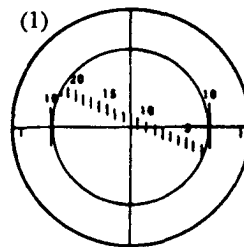

30. List the actions taken in the event of a misfire on an M109A2/A4 howitzer (cold tube, charges 2 through 8).

Note: Requirements 31 through 33 are based on the safety T diagram shown below, which was computed for charge 4.

| | | |
|------------------|-------|-----------|
| MAX QE | 417 | |
| DF LIMITS | 3685 | 3315 2900 |
| MIN QE | 209 | 177 |
| MIN SAFE FS M564 | 12.6 | 10.7 |
| MIN SAFE FS M732 | 314.0 | 282.0 |

State whether the following data are safe or unsafe to fire; if unsafe, state why.

31. Lot XY, chg 4, fz quick, df 3695, QE 347.

32. Lot XY, chg 4, fz ti, ti 12.2, df 3472, QE 253.

33. Lot XY, chg 4, fz vt, ti 17.0, df 3515, QE 315.

34. List the action taken in the event of a misfire on an M109A2/A4 howitzer (hot tube, charge 3).

35. Describe the method for measuring the greatest angle of site to a crest in front of the howitzer and list the four methods of determining piece-to-crest range.

SOLUTION TO QUALIFICATION TEST I

Part 1: True and False

- | | | |
|----------|-----------|----------|
| 1. True | 6. False | 11. True |
| 2. False | 7. False | 12. True |
| 3. True | 8. True | 13. True |
| 4. True | 9. False | 14. True |
| 5. True | 10. False | 15. True |

Part 2: Multiple Choice

16. d. 18. a. 20. a. 22. b. 24. d.
17. c. 19. c. 21. c. 23. a. 25. c.

Part 3: Completion

26. How are white phosphorus projectiles stored? Explain why.

They are stored on their bases to prevent improper settling of the projectile filler, and away from other ammunition.

27. If a VT fuze does not seat properly in the fuze well, what actions should be taken?

The fuze should be removed. Check the round to see if the supplementary charge is still in the fuze well (M500 series and M728 only). If it is, remove it and install the fuze. If it still does not seat properly, remove it and turn it in to the ammunition section.

28. Describe the method for placing out safety stakes.

Set on the sight, in turn, the left, intermediate; and right deflection limits determined from the safety card, and take up a proper sight picture on the aiming point. Sight through the breech end of the tube; and, sighting along the left edge of the tube for the left limit and the right edge of the tube for the right limit, align the safety stakes.

29. Which of the following sight diagrams illustrate correct sight pictures? Indicate your answer by placing an X in the appropriate spaces below.

- a. (2) b. (4)

30. List the actions taken in case of a misfire on an M109A2/A4 howitzer (cold tube, charge 2 through 8).

After a failure to fire, try to fire two additional times. If the weapon still fails to fire, wait 2 minutes from the last attempt to fire and then remove and inspect the primer.

a. If the primer is not dented, the fault is in the firing mechanism. Repair the firing mechanism; prime, and then fire the weapon.

b. If the primer is dented, the primer is at fault. Replace the primer with another primer and then fire the weapon.

c. If the primer fired, the fault is with the propelling charge. Wait 10 minutes (8 minutes after removal and inspection of the primer), open the breech, and remove and dispose of the defective propelling charge. Reload the weapon with a new propelling charge and primer for firing.

31. Unsafe; deflection exceeds left limit by 10 mils.

32. Unsafe; time is 0.4 second less than minimum time.

33. Unsafe; time is 2.0 seconds less than minimum time.

34. List the action taken in the event of misfire on an M109A2/A4 (hot tube, charge 3).

After a failure to fire, try to fire two additional times. If the weapon still fails to fire, wait 2 minutes from the last attempt to fire and then remove and inspect the primer.

a. If the primer is not dented, the fault is in the firing mechanism. Repair the firing mechanism, prime the weapon, and then fire it within 5 minutes from the time the round was chambered.

b. If the primer is dented, the primer is at fault. Replace the primer with another primer and then fire the weapon within 5 minutes from the time the round is chambered.

c. If the primer fired, the fault is with the propelling charge. If it is a combat emergency, insert another primer and then try to fire the weapon within 5 minutes from the time the round was chambered.

d. If for any reason the projectile is not removed from the tube within 5 minutes of cambering, evacuate all personnel from the weapon and notify explosive ordnance disposal for removal of the projectile.

35. Describe the method for measuring the greatest angle of site to a crest in front of the howitzer and list the four methods of determining piece-to-crest range.

Looking through the tube, sight along the lowest element of the bore and direct the movement of the tube until the line of site just clears the highest point on the crest in front of the howitzer. Center the cross-level and pitch-level bubbles, and read the elevation; this is the greatest angle of site. The four methods of determining piece-to-crest range are taping, map measurement, pacing, and estimation.

QUALIFICATION TEST II

Part 1: True and False

1. ____ The XO must compare the safety card minimum QE with the XO's minimum QE and use the larger.

2. ____ In indirect fire, the safety officer must ensure that the visible portion of the impact area is clear of personnel.

3. ____ The OIC may authorize the firing of all types of ammunition from a firing point, if he ensures that the proper charge is being fired.

4. ____ Before illuminating rounds are fired, the position commander must ensure that the firing of those rounds is authorized on his safety card.

5. ____ The OIC must ensure that range clearance has been obtained before the battery may fire.

6. ____ CHECK FIRING will be commanded only by the plt ldr.

7. ____ Firing will be halted when the range control commands CHECK FIRING.

8. ____ The plt ldr will verify the boresight of each piece prior to firing in each position.

9. ____ Excess powder should be piled as high as possible for burning to prevent spreading of the flames and to reduce the chance of starting a range fire.

10. ____ Because of the great range of the M110A2 howitzer, drift must be considered in the computation of safety limits prior to the registration.

Part 2: Multiple Choice

11. Verifying the boresight of each weapon is the specific responsibility of the-

a. section chief.

b. OIC of firing.

c. platoon leader.

d. OIC of firing and FDO.

12. The FDO has computed a minimum QE of 186 mils and the plt ldr has determined a minimum QE of 195 mils for shell HE and fuzes quick and time. Which QE should be used as the safe minimum QE?

a. 186

b. 190

c. 195

d. either 186 or 195

13. To inscribe a GFT setting on a GFT after a registration has been completed, the manufacturer's hairline is placed over the-

- a. adjusted time.
- b. adjusted elevation.
- c. chart range.
- d. adjusted quadrant.

Part 3: Completion

14. Before leaving for the field, all officers in the chain of command responsible for safety should read and understand five references. They are as follows:

- a. _____
- b. _____
- c. _____
- d. _____
- e. _____

15. Equipment and material required by safety personnel in the field include the following:

- a. _____
- b. _____
- c. _____
- d. _____
- e. _____
- f. _____

16. Upon arrival at the prescribed firing point, the position commander must check and verify the following:

- a. _____
- b. _____
- c. _____
- d. _____

17. When the battery is laid by the grid azimuth method, the aiming circle can be no closer than _____ meters to artillery weapons.

18. The platoon has been laid on an azimuth of 0430 mils. You are prepared to check the lay. The declination constant of your aiming circle is 0130 mils. What instrument reading would you place on the scales by use of the upper

motion when you are preparing to orient your aiming circle on the azimuth of fire?

19. If a VT fuze does not seat properly in the fuze well, what actions should be taken?

20. Describe the procedures for burning unused powder increments.

21. At the firing point, how do you verify the declination constant on the aiming circle?

22. How does the position commander verify the initial lay of the platoon at a firing point if the laying circle used the orienting angle method?

23. Describe the procedures used by the chief of section in the testing target method to verify that the panoramic telescope and the direct fire telescope of each howitzer are aligned with the bore of the howitzer.

Part 4: Performance

24. Situation: You are the platoon leader of a 155-mm M109A3 platoon firing shell HE, charge 5 green bag, fuzes M557, M564, and M728. The piece-to-crest range is 1,000 meters. The reported angles of site are as follows:

- Number 1: +14 mils
- Number 2: +15 mils
- Number 3: +18 mils
- Number 4: +14 mils

Required:

a. What is the platoon leader's minimum QE for firing fuzes quick and mechanical time?

b. What is the minimum safe time for fuze VT M728?

c. What is the platoon leader's minimum QE for firing fuze VT with a fuze setting less than the minimum safe

Show work:

25. Situation: You are the platoon leader of a 155-mm, M109A3 firing charge 4 green bag. The platoon is laid on azimuth 2150.

a. You have determined the following data:

| | Maximum altitude | Minimum altitude |
|--------------------|---------------------|---------------------|
| Maximum range | 377 | 368 |
| Intermediate range | 341 | 327 |
| Minimum range | 324 | 320 |

b. Platoon location grid 6072 3426, altitude 339.

c. The following data were taken from the safety card:

Safety limits for 155-mm SP howitzer, shell HE, fuzes M557, M564, and M514 are as follows:

- Left limit: Azimuth 1725
- Minimum range: 3,700 meters
- Right limit: Azimuth 2535
- Maximum range: 7,100 meters

Charge 4 green bag only
Low-angle fire only

Special instructions: From azimuth 1725 to azimuth 1925 the minimum range is 4,200 meters.

Required: Complete the safety diagram.

Show work:

26. Situation continued: The platoon has completed a precision registration and the FDC determined the following GFT setting:

Chg 4GB, lot XY, rg 4750, el 260, ti 15.2

Total deflection correction R12

Required: Using these registration corrections, compute the modified safety diagram you will now use. (Use the given data from requirement 25.)

Show work:

27. Situation: You are the fire direction officer for a 155-mm M109A3 platoon firing charge 4 green bag. The platoon is laid on azimuth 5900.

a. You have determined the following data:

| | Maximum | Minimum |
|---------------|----------|----------|
| | altitude | altitude |
| Maximum range | 395 | 389 |
| Minimum range | 388 | 364 |

b. Platoon location: grid 5845 4213, altitude 341.

c. The following data were taken from the range safety card:

| | |
|----------------|--------------|
| Left limit: | Azimuth 5580 |
| Minimum range: | 5,200 meters |
| Right limit: | Azimuth 6260 |
| Maximum range: | 6,900 meters |

Charge 4 green bag only

High-angle fire only

Required: Complete the safety diagram, and compute the safety data.

Show work:

28. Situation: You are the fire direction officer for a 155-mm M109A3 platoon firing charge 4 green bag. The platoon is laid on azimuth 2050.

a. You have determined the following data:

| | Maximum | Minimum |
|---------------|----------|----------|
| | altitude | altitude |
| Maximum range | 377 | 368 |
| Minimum range | 324 | 320 |

b. Platoon altitude: 339 meters.

c. The following data were taken from the safety card:

Safety limits for 155-mm SP howitzer, shell ICM M483A1 are as follows:

| | |
|----------------|--------------|
| Left limit: | Azimuth 1675 |
| Minimum range: | 4,400 meters |
| Right limit: | Azimuth 2435 |
| Maximum range: | 7,000 meters |

Charge 4 green bag only

Low-angle fire only

Required: Complete the safety diagram, and compute the safety data.

Show work:

Required: Complete the safety diagram, and compute the safety data.

Show work:

29. Situation: You are the fire direction officer for a 155-mm M109A3 platoon firing charge 5 green bag. The platoon is laid on azimuth 2050.

a. You have determined the following data:

| | Maximum altitude | Minimum altitude |
|---------------|---------------------|---------------------|
| Maximum range | 377 | 368 |
| Minimum range | 385 | 320 |

b. Platoon altitude: 339 meters.

c. The following data were taken from the range safety card:

Left limit: Azimuth 1675
 Maximum range: 7,000 meters
 Right limit: Azimuth 2436
 Minimum range: 4,400 meters
 Charge 5 green bag only.
 Shell illuminating only.

SOLUTION TO QUALIFICATION TEST II

Part 1: True and False

1. True 3. False 5. True 7. True 9. False
 2. True 4. True 6. False 8. True 10. True

Part 2: Multiple Choice

11. a. 12. c. 13. c.

Part 3: Completion

14. Before leaving for the field, all officers in the chain of command should read and understand five references. They are as follows:

- a. AR 385-63
 b. FM 6-50, Chapter 11
 c. TM 43-0001-28
 d. Appropriate TM for the weapon
 e. Post range regulations

15. Equipment and material required by safety personnel in the field include the following:

- a. authorized safety card.
- b. applicable tabular firing tables.
- c. applicable graphical firing tables.
- d. applicable graphical site tables.
- e. map of the area.
- f. aiming circle.

16. Upon arrival at the prescribed firing point, the platoon leader must check and verify the following:

- a. that the safety card applies to the firing unit, exercise, and date.
- b. that the platoon is in the position as specified on the card.
- c. the boresighting of each weapon.
- d. the laying of the platoon.

17. When the battery is laid by the grid azimuth method, the aiming circle must be no closer than 75 meters to artillery weapons.

18. The platoon has been laid on an azimuth of 0430 mils. You are preparing to check the lay. The declination constant of your aiming circle is 0130 mils. What instrument reading would you place on the scales by use of the upper motion when you are preparing to orient your aiming circle on the azimuth of fire? 6,100 mils.

19. If a VT fuze does not seat properly in the fuze well, what actions should be taken?

Remove the fuze, and check to see if the supplementary charge is still in the fuze well (M500 series and M728 only). If it is, remove it and install the fuze. Then if the fuze does not seat properly, remove it and turn it in to the ammunition section.

20. Describe the procedures for burning unused powder increments.

The burning site will be at least 200 feet from debris and grass, personnel, and equipment. All powder charge increments to be destroyed should be placed in a single-layer row not more than 12 inches wide. The row of increments should be placed so that burning will progress into the direction of the wind. A train of combustible material about 15 feet long should be placed perpendicular to, and at the downwind end of, the row of increments. The combustible materials should be lit at the end farthest from the row of

increments. Igniter pads and flash reducers will be placed at the upwind end of the row of increments to be destroyed.

21. At a firing point, how do you verify the declination constant of the aiming circle?

Set up the aiming circle over any point from which the azimuth to another visible point is known. Using the **upper** motion, set the known azimuth on the scales. Using the **lower** motion, sight on the known point. Release the magnetic needle, and, using the **upper** motion, center it. Read the value on the scales, and compare it to the declination constant. If the two values compare within 2 mils, the declination constant is valid. If not, the aiming circle should be redeclinated in accordance with FM 6-50, Chapter 4.

22. How does the position commander verify the initial lay of the platoon at a firing point if the lay circle used the orienting angle method?

A declinated aiming circle, oriented on the azimuth of lay, will be set up at least 10 meters away from the lay circle. Referred readings will be taken between the two aiming circles and they must agree within 10 mils or as dictated by local range regulations/unit SOP. The platoon leader will command the pieces to refer to the verification circle after the weapons have established an aiming point and verified boresight. The referred readings between the verification circle and the pieces must agree with criteria established by local range regulations/unit SOP.

23. Describe the procedures used by the chief of section using the testing target method to verify that the panoramic telescope and the direct fire telescope of each howitzer are aligned parallel to the bore of the howitzer.

a. The chief of section will verify that the panoramic telescope gunner's aid counter is set to 0, the muzzle cross hairs are centered on the center aiming diagram, the telescope mount is level, and the azimuth counter shows 3,200 mils when the panoramic telescope reticle is laid precisely on the left aiming diagram.

b. The chief of section will verify that the elbow telescope cross-level bubble is centered, the range gauge line of the elbow telescope is set on zero elevation, and the reticle of the elbow telescope coincides with the right pattern of the testing target.

Part 4: Performance

Note: Some of the problems will have cuts listed which exceed the maximum allowable. If the maximum allowable cuts are exceeded, only the maximum points shown will be lost.

24. (Weight 15)

Angle 1 +18 (value -1) Angle 2 +6 (value -1)
 Angle 3 +1 (value -1) Angle 4 +38 (value-2)
 Angle 5 +2 (value -1)
 Expression errors -1
 Mathematical error -1

a. Minimum QE 65 (Maximum cut -6)

b. Minimum safe time =

$$2.8 + 5.5 = 8.3 \text{ 9.0}$$

(-1) (-1) (-1)

(Maximum cut for this part of problem -3)

Angle 1 +18 Angle 2 +72

Angle 3 +1 Angle 4 +38

Angle 5 +2

c. Minimum QE 131 (Maximum cut -6)

Entire problem maximum cut -15

Maximum cuts for expression for entire problem -2

25. (Weight 25)

Diagram construction:

Deflection and azimuth - 1 ea

Dog leg positioning - 3

Expression errors - 1

Math errors - 1

Deflection other than 3200-3

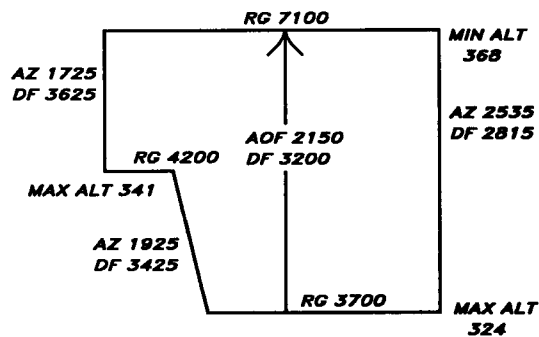
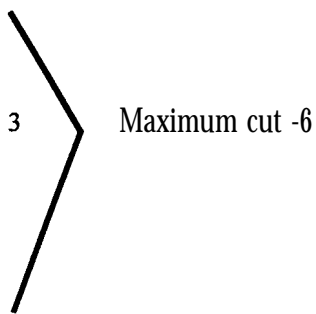

| CHG | RG | ALT USED | QE | FS M564 | FS M514 |
|-----|------|----------|---------|---------|---------|
| 4GB | 7100 | 368 | 508 | | |
| 4GB | 4200 | 341 | 244 | 14.7 | 21.0 |
| 4GB | 3700 | 324 | 205 | 12.7 | 19.0 |
| | | | (-2 EA) | (-2 EA) | (-3 EA) |

Maximum cut for entire problem -25.

26. (Weight 25)

Diagram: Deflection and azimuth -2 each (Maximum cut -6)

Failure to use GFT setting -15

FS M514, did not apply 5.5 -2

Expression -1

Math error -1

Deflection other than 3200-3

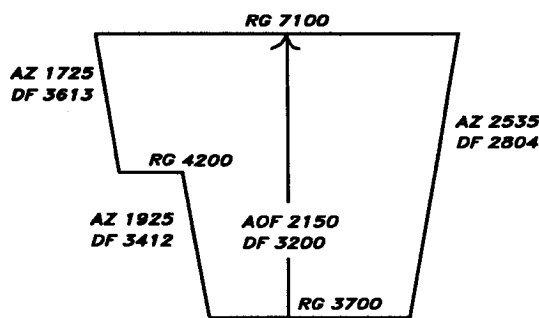

| RG | QE | FS M564 | FS M514 |
|------|--------|---------|---------|
| 7100 | 522 | | |
| 4200 | 248 | 13.8 | 20.0 |
| 3700 | 209 | 12.0 | 18.0 |
| | (-2EA) | (-1EA) | (-3EA) |

Maximum cut for entire problem -25

27. (Weight 20)

Diagram: Deflection and azimuth -2 each (maximum cut -4)
 Drift -2 each (maximum cut -4)
 Math errors -1
 Expression errors -1
 Deflection other than 3200-3

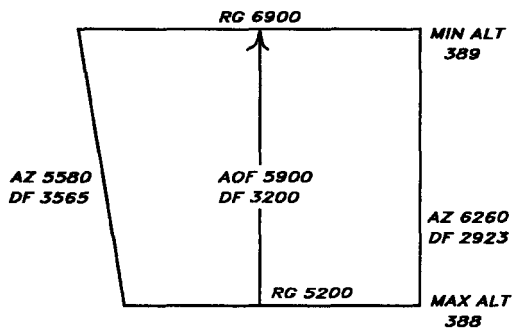

| CHG | RG | QE |
|-----|------|--------|
| 4GB | 6900 | 1080 |
| 4GB | 5200 | 1236 |
| | | (-5EA) |

Maximum cut for entire problem -20.

29. (Weight 10)

Diagram: Deflection and azimuth - 1 each (maximum cut -2)
 Expression errors -1
 Math errors -1

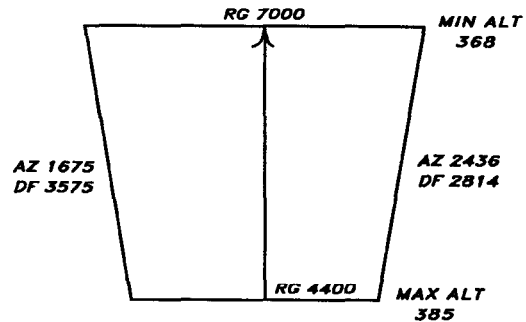

| CHG | RG | MAXIMUM ALT | QE |
|-----|------|-------------|------|
| 5GB | 7000 | 368 | 369 |
| | | | (-3) |

| CHG | RG | MAXIMUM ALT | QE | FS M564 |
|-----|------|-------------|------|---------|
| 5GB | 4400 | 385 | 208 | 13.7 |
| | | | (-3) | |

Maximum cut for entire problem -10

28. (Weight 10)

Diagram: Deflection and azimuth -1 each (maximum cut -2)
 Expression errors -1
 Math errors -1

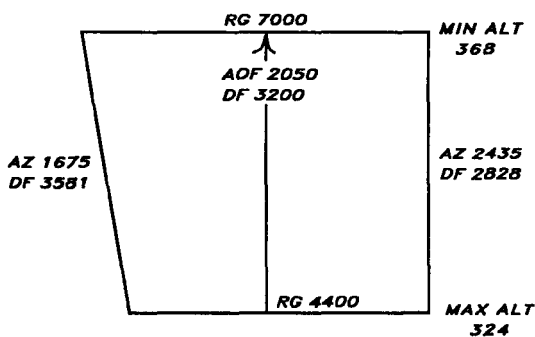

| CHG | RG | QE | FS |
|-----|------|--------|------|
| 4GB | 7000 | 598 | |
| 4GB | 4400 | 326 | 15.2 |
| | | (-1EA) | (-2) |

O-2. HANDS-ON SAFETY CERTIFICATION

a. Description.

(1) The hands-on safety certification test presented here is a sample of a test to be conducted in conjunction with the written safety test. The hands-on safety certification allows the commander to determine if subordinate leaders are adequately prepared to perform safety-related duties during live-fire exercises.

(2) Conduct this test in a field location. The battalion survey section will establish the orienting station, orienting line, end of orienting line, and several known aiming points with known direction. The unit being evaluated will provide all necessary equipment to perform all listed tasks. The S3 will provide inert training rounds, fuzes, and propellant.

(3) The certification test must approximate the conditions and stress that a safety-certified person will encounter. This test does not specify a maximum allowable time for completion of individual tasks. The appropriate AMTP can be used as a standard.

b. Test Administration.

(1) The test should be conducted to certify, as a minimum, the battery commander, platoon leaders, fire direction officers, platoon sergeants, gunnery sergeants, chief computer, and howitzer section chiefs.

(2) The battalion commander will evaluate the battery commander on the tasks listed in Table O-2. When the battery commander has been certified, he, the battalion executive officer, and S3 will conduct the certification of the battery personnel.

(3) The platoon leaders and fire direction officers will be evaluated on the tasks listed in Table O-3. The platoon sergeants and gunnery sergeants will be evaluated on the tasks listed in Table O-4. The howitzer section chiefs will be evaluated on tasks listed in Table O-5, and the chief computer and/or fire direction specialists will be evaluated on the tasks listed in Table O-6.

(4) Howitzer sections will be given a series of dry fire missions which they will be required to process. During these missions, the howitzer section chiefs will be evaluated on their ability to determine if the commands sent are safe to fire. The section chief will have his section members perform their individual tasks during fire mission processing to verify proper procedures are being used. (See paragraph c below.)

(5) There are 17 errors that may occur on the howitzer if the howitzer is not checked before every round is fired. Those errors will cause a fining incident. They must be prevented by the safety NCO who safes the weapon before firing. A safety NCO that overlooks any one of these 17 possible errors will eventually fire an unsafe round.

Table O-2. Battery commander tasks

| NUMBER | TASK |
|--------|---|
| 1. | Declinate the aiming circle by using an established or field expedient declination station. |
| 2. | Orient the aiming circle by using both grid azimuth and orienting angle methods. |
| 3. | Verify the azimuth to EOL. |
| 4. | Measure the azimuth. |
| 5. | Lay platoon using the M2 compass method and distant aiming point method. |
| 6. | Perform hasty survey. Conduct a two leg directional traverse by using BUCS or BCS. |
| 7. | Conduct a simultaneous observation both as the master and flank station. |
| 8. | Establish direction by using Polaris Kochab or Polaris II methods. |
| 9. | Verify safety and position data. |
| 10. | Place howitzer in order using TLABSPAP. |
| 11. | Conduct hot and cold tube misfire procedures. |
| 12. | Compute platoon leader/XO's minimum QE. |
| 13. | Identify proper shell-fuze combinations and set time with proper fuze setter. |
| 14. | Reciprocally lay another howitzer. |

Table O-3. **Platoon leaders and fire direction officers tasks**

| NUMBER | TASK |
|--------|---|
| 1. | Complete all tasks listed in Table O-2. |
| 2. | Place safety limits on the howitzer. |
| 3. | Transmit voice fire commands to the howitzer section. |
| 4. | Construct a safety box on the firing chart or map. |

Table O-4. **Platoon sergeant and gunnery sergeant tasks**

| NUMBER | TASK |
|--------|---|
| 1. | Complete all tasks listed in Table O-2 except for tasks 6, 9, and 12. |
| 2. | Lay the platoon using the howitzer backlay method. |
| 3. | Place safety limits on the howitzer. |
| 4. | Conduct the end-for-end test and the micrometer test. |

Table O-5. **Howitzer section chief tasks**

| NUMBER | TASK |
|--------|---|
| 1. | Place the howitzer in order by using the memory aid TLABSPAP. |
| 2. | Conduct hot and cold misfire procedures. |
| 3. | Place safety limits on the howitzer. |
| 4. | Reciprocally lay another howitzer. |
| 5. | Identify proper shell-fuze combinations and set times with the proper fuze setters. |
| 6. | Conduct end-for-end test and micrometer test. |
| 7. | Conduct dry-fire missions with the entire section (paragraph c below). |

Table O-6. **Chief computer and/or fire direction specialist tasks**

| NUMBER | TASK |
|--------|--|
| 1. | Construct a safety box on the firing chart or map. |
| 2. | Construct a safety T by using a safety diagram. |
| 3. | Insert safety and position data into BCS or BUCS. |
| 4. | Transmit voice fire commands to the howitzer sections. |
| 5. | Obtain range clearance. |

c. **Dry-Fire Mission for Section Chief Safety Test.** To present a stressful exam that can identify safe chiefs, this test consists of 10 fire missions. In the process of those 10 missions, all 17 errors that will cause firing incidents occur. The test sight is set up as close to a live fire situation as possible. Cannoneers set off the induced errors, have them corrected, and fire the 10 missions safely to pass the test. Annexes to this hands-on test are as follows:

- Annex 1- The 17 errors that can occur in a mission.
- Annex 2- The 10 fire missions (with error annotated).
- Annex 3- Section member cue cards. The data that each one of the section members sets off.
- Annex 4- The safety Ts that the chief being tested will use.
- Annex 5- The inbriefing to the test sight.
- Annex 6- The equipment needed at the test sight.
- Annex 7- A grade sheet.

**ANNEX 1
ERRORS THAT WILL CAUSE
A FIRING INCIDENT**

SAFETY T (Errors T1 - T6)

- T1. Shell not authorized
- T2. Charge not authorized
- T3. Deflection not authorized
- T4. Quadrant not authorized
- T5. Fuze not authorized
- T6. Time setting not authorized

Note: The test is written so that three safety Ts apply in the firing point. The chief must pick the appropriate safety T on the basis of the charge given in the fire commands and then safe the mission using that safety T.

ASSEMBLY OF PROJECTILE (Errors A1 - A4)

- A1. Wrong fuze used
- A2. Wrong shell used
- A3. Wrong charge used
- A4. Wrong fuze setting

Notes:

1. This test is written to work with vernier scale fuzes (M564, M565) or the digital fuzes (M577, M582). Even though 105-mm ammunition often comes prefuzed, the chief should be familiar with authorized shell/fuze combinations and must check his prefuzed ammunition to preclude any incidents.
2. This test is designed to work with both standard 105-mm propelling charges (1-7) and 155-mm propelling charges for green bag.

INCORRECT DATA SET ON THE WEAPON (Errors W1 - W7)

- W1 Pantel: Bubbles not centered
- W2 Pantel: individual piece correction set off
- W3 Pantel: Wrong deflection set off
 - a. Numbers transposed
 - b. Azimuth and reset counter not in synchronization for aiming point used
- W4 Pantel: Sight picture off
 - a. Aiming posts
 - b. Collimator
- W5 Quadrant: Bubbles not centered
- W6 Quadrant: Individual piece correction off
- W7 Quadrant: Numbers transposed on elevation counter

Notes:

1. This test was written with a bias for the M100-series sights. The induced errors are those errors most likely to occur on the pantels with digital counters (transposed numbers). Should you test an M101A1 weapon system chief, the test should be modified so that the more likely 100 mil errors are induced, rather than transposed numbers [W3a, W7].
2. Error W3b is for an M100-series sight with reset counter. If testing a weapon with a 12-series sight, the slipping scale should be slipped 30 mils out of synchronization with its original orientation to effect the same error.

**ANNEX 2
FIRE MISSIONS**

Note: If testing a 155-mm section chief, then state **GREEN BAG** on all charge commands. C (collimator) and AP (aiming posts) in DF commands are the designated aiming points.

Fire Mission 1 (errors: A2, T2, W3a)

Shell: Smoke (shell WP set up)
Charge: 4 (not authorized by safety T)
Fuze: Time
Time: 18.9
DF: C 3043 (transpose DF numbers [3403])
QE: 369
 If called unsafe because the charge is off the safety T, say **CORRECTION, CHARGE 3, QUADRANT 369.**

Fire Mission 2 (error: A3)

Shell: HE
Charge: 3 (all charge bags not initially present)
Fuze: TIME
Time: 13.9
DF: AP 3104
QE: 387

Fire Mission 3 (errors: T1 and W4a)

Shell: WP (no WP on charge 5 safety T)
Charge: 5
Fuze: PD
DF: AP 3441 (sight picture on aiming posts off)
QE: 251
 Set time fuze (M582 or M564) for PD action
 If unsafe because there is no WP on charge 5 safety T, say **CORRECTION, CHARGE 3, QUADRANT 251.**

Fire Mission 4 (Errors: T4 and W6)

Sp Inst: High angle

Shell: HE

Charge: 5

Fuze: PD

DF: AP 3402

QE: 1107 (quadrant off safety T)

If unsafe because QE is off of the safety T, say
CORRECTION, QUADRANT 1080.

Fire Mission 5 (Errors: A1, A3, T6)

Shell: Smoke

Charge: 3 (charge 4 is cut)

Fuze: TIME (MTSQ used: M564 or M582)

Time: 14.1 (time setting is off safety T)

DF: AP 3026

QE: 360

If unsafe because the time is off of the safety T, say
CORRECTION, TIME 15.9.

Fire Mission 6 (Errors: A4, W4b)

Shell: HE

Charge: 3

Fuze: Time

Time: 14.9 (time 13.9 set on M564/149.0 set on M582)

DF: C 3307 (incorrect sight picture on collimator)

QE: 360

Pick up displacement on wrong side of zero

Fire Mission 7 (Errors: W7)

Shell: WP

Charge: 3

Fuze: Time

Time: 21.2

DF: AP 3395

QE: 317 (QE 371 set off)

Fire Mission 8 (SAFE)

Shell: WP

Charge: 3

Fuze: PD

DF: C 3033

QE: 224

Fire Mission 9 (errors: A1, T3, W1, W2)

Shell: HE

Charge: 3

Fuze: TIME (M728 VT FUZE USED)

Time: 19.0

DF: C 2963 (deflection off of safety T)

(gunner's cross-level bubble off)

(individual piece correction: L10)

QE: 360

If called unsafe because deflection is off the safety T,
say **CORRECTION, DEFLECTION**
2973/QUADRANT 360.

Fire Mission 10 (errors: T5, W3b, W5)

Shell: HE

Charge: 5

Fuze: VT (fuze VT not authorized on chg 5 safety T)

Time: 25.0

DF: C 3051 (reset/az counters out of sync 30 or more)

**ANNEX 3
CUE CARDS**

| GUNNER | | |
|----------------|--------------|--|
| MISSION NUMBER | AIMING POINT | DF TO SET OFF |
| 1.* | C | 3403 (transposed numbers) [3043] |
| 2. | AP | 3104 |
| 3.* | AP | 3441 (pick up displacement using line, far, near) |
| 4. | AP | 3402 |
| 5. | AP | 3026 |
| 6.* | C | 3307 (pick up sight picture on wrong side of zero) |
| 7. | AP | 3395 |
| 8. | C | 3033 |
| 9. | C | 2963 (CORRECTION DEFLECTION 2973) (cross-level bubble off) (individual piece correction: L10)* |
| 10.* | C | 3051 reset and/or azimuth counter out 30 mils. |
| *induced error | | |

| ASSISTANT GUNNER | |
|------------------|---|
| MISSION | QE TO SET OFF |
| 1. | 369 |
| 2. | 387 |
| 3. | 251 |
| 4.* | 1107 (CORRECTION DEFLECTION 2973) (cross-level bubble off) (individual piece correction: L10) |
| 5. | 360 |
| 6. | 360 |
| 7.* | 371 (transposed numbers [317]) |
| 8. | 224 |
| 9. | 360 |
| 10.* | 315 (cross-level bubble off) |
| *induced error | |

| NUMBER 1 CANNONEER (sets time on time fuzes) | | |
|---|--------------------------|----------------------|
| MISSION NUMBER | FUZE TO SET DATA ON | TIME TO SET FUZE FOR |
| 1. | M565/M577 | 18.9 |
| 2. | M564/M582 | 13.9 |
| 3. | M564/M582 (▲ 98.0) | 90.0 |
| 4. | M564/M582 (▲ 98.0) | 90.0 |
| 5.* | M564/M582 | 14.1 |
| Note: 14.1 is below minimum safe time on the safety T. If CORRECTION TIME 15.9, set time on 15.9 | | |
| 6.* | M564/M582 (▲ 149.0) | 13.9 |
| Note: Announced time is 14.9 (set it off if error above is found). | | |
| 7. | M564/M582 | 21.2 |
| 8. | M564(1970)/M582 (▲ 98.0) | "S" |
| 9. | M728/514/732 | 19.0 |
| Note: Incorrect fuze (FUZE TIME announced/VT setup. Set up proper fuze if error found). | | |
| 10.* | M728/514/732 | 25.0 |
| Note: If CORRECTION FUZE TIME, TIME 25.0, set up (M564/M582) 25.0. | | |
| *induced error | | |

| NUMBER 2 CANNONEER (mounts fuze on projectile) | | |
|--|-----------|---------------|
| MISSION NUMBER | ANNOUNCED | FUZE TO MOUNT |
| 1. | Time | M565/M577 |
| 2. | Time | M564/M582 |
| 3. | PD | M564/M582 |
| 4. | PD | M564/M582 |
| 5.* | Time | M564/M582 |
| Note: Fuze should be base ejecting (M565/M577). (Set up proper fuze if error is found.) | | |
| 6. | Time | M564/M582 |
| 7. | Time | M564/M582 |

| NUMBER 2 CANNONEER (mounts fuze on projectile) (Continued) | | |
|---|-----------|------------------------|
| MISSION NUMBER | ANNOUNCED | FUZE TO MOUNT |
| 8. | PD | M564/M582 |
| 9.* | Time | M728/514/732 |
| Note: Incorrect fuze (FUZE TIME announced/VT setup) (set up M564/M582 if error is found) | | |
| 10.* | VT | M728/514/732 (25.0) |
| Note: Safety T does not allow VT. if CORRECTION FUZE TIME, TIME 25.0 is announced then set up fuze time (M564/M582) 25.0. | | |
| *induced error | | |

| NUMBER 4 CANNONEER (prepares projectile) | | |
|---|---------------------------------|--|
| MISSION NUMBER | PROJECTILE TO PREPARE INITIALLY | FINAL PROJECTILE (if errors are found) |
| 1.* | WP (SMOKE is announced) | SMK |
| 2. | HE | |
| 3.* | WP | WP |
| 4. | HE | |
| 5. | SMK | |
| 6. | HE | |
| 7. | WP | |
| 8. | WP | |
| 9. | HE | |
| 10. | HE | |
| *induced error | | |

| NUMBER 3 CANNONEER (cuts powder) | | |
|-------------------------------------|-----------------------------|------------------------------------|
| MISSION NUMBER | CHARGE TO PREPARE INITIALLY | FINAL CHARGE (IF ERRORS ARE FOUND) |
| 1.* | 4 (CORRECTION CHARGE 3) | 3 |
| 2.* | 3 (Number 2 bag left out.) | 3 |
| 3.* | 5 (CORRECTION CHARGE 3) | 3 |
| 4. | 5 | 5 |
| 5.* | 4 (CHARGE 3 is announced) | 3 |
| 6. | 3 | 3 |
| 7. | 3 | 3 |
| 8. | 3 | 3 |
| 9. | 3 | 3 |
| 10. | 5 | 5 |
| *induced error | | |

**ANNEX 4
SAFETY Ts**

Firing Point: SAFETY
Azimuth of Fire: 2600
Low Angle
Charge: 5

| | | | |
|------------------|------|------|------|
| MAX QE | 282 | 321 | |
| DF | 3446 | 3306 | 3015 |
| MIN QE HE/HC SMK | 156 | 187 | |
| TI | 13.1 | 14.2 | |
| VT | 18.0 | 19.0 | |

Firing Point: SAFETY
Azimuth of Fire: 2600
Low Angle
Charge: 3

| | | | |
|-------------------------|-------------|-------------|-------------|
| MAX QE | 358 | 404 | |
| DF | 3450 | 3306 | 3028 |
| MIN QE HE/HC SMK | 162 | 214 | |
| MIN QE WP | 185 | 237 | |
| TI | 13.7 | 14.6 | |
| VT | 19.0 | 20.0 | |

Firing Point: SAFETY
Azimuth of Fire: 2600
High Angle
Charge: 5
Shell: HE

| | | | |
|---------------|-------------|-------------|-------------|
| MAX QE | 1082 | 1168 | |
| DF | 3514 | 3374 | 3095 |
| MIN QE | 892 | 861 | |

ANNEX 5

IN-BRIEFING TO TEST SITE

1. Here are your authorized safety Ts for this firing point.
2. The platoon sergeant just assigned you to be the safety NCO for this howitzer because the chief was sent on emergency leave.
3. Your crew consists of a gunner, an ammunition team chief, an assistant gunner, cannoneers #1 and #2, and a driver. I will be both the FDC and test administrator.
4. The weapon is laid and safed, and prefire checks have been done.

5. Your GDU is down, so you will be getting voice fire commands.
6. There are no individual piece corrections for this weapon in this position.
7. You will be given 10 fire missions; you must fire all missions.
8. If you encounter an error on your weapon, state UNSAFE and the nature of the unsafe condition to me.
9. After I check the error and the error is corrected, continue to safe the weapon till all errors are corrected; and then fire the mission.
10. The round will not be rammed. That will be simulated.
11. The gunner may sight on either the collimator or the aiming posts to fire the mission. Both aiming reference points have been safety-checked by the platoon sergeant earlier.
12. The evaluator will read your section all 10 missions. If you have any questions about a fire command, have him repeat the needed command.
13. You must score GOs on all induced safety errors to pass this test.

ANNEX 6

REQUIRED EQUIPMENT

- Howitzer with section equipment.
- Howitzer crew (7 men).
- Collimator (with 10 mils displacement at DF 3200).
- Aiming posts (with 10 mils displacement at DF 3200).
- Dummy or inert rounds (HE, WP, HC smoke).
- Dummy or inert fuzes (M564 or M582, M565 or M557, M728/M514 or M732).
- Dummy or inert charges (two complete sets for 105-mm, two complete green bag sets for 155-mm).
- DA Form 5212-R (Gunner's Reference Card).

**ANNEX 7
GRADE SHEET**

NAME _____

RANK _____

DATE _____

EVALUATOR _____

WEAPON SYSTEM _____

| MISSION | ERROR | DESCRIPTION | GO | NO-GO |
|---------|-------|--|----|-------|
| 1. | A2 | Incorrect shell used. | | |
| | T2 | Charge not authorized on safety T. | | |
| | W3a | Transposition of numbers on reset counter. | | |
| 2. | A3 | All charge bags not initially present. | | |
| 3. | T1 | Shell not authorized on safety T. | | |
| | W4a | Sight picture on aiming post off. | | |
| 4. | T4 | Quadrant not authorized on safety T. | | |
| | W6 | Individual piece correction set off (QE). | | |
| 5. | A1 | Explosive time fuze (M564 or M582) used on base ejecting round. | | |
| | A3 | Incorrect charge cut. | | |
| | T6 | Time setting not authorized on safety T. | | |
| 6. | A4 | Time fuze not set correctly for desired action (M564 or M582). | | |
| | W4b | Sight picture on collimator off. | | |
| 7. | W7 | Transposition of numbers on elevation counter. | | |
| 8. | SAFE | | | |
| 9. | A1 | VT fuze used instead of time fuze. | | |
| | T3 | Deflection not authorized on safety T. | | |
| | W1 | Bubbles not level on pantel mount. | | |
| | W2 | Individual piece corrections set off on pantel. | | |
| 10. | T5 | Fuze not authorized on safety T. | | |
| | W3b | Azimuth and reset counters out of synchronization for aiming point used. | | |
| | W5 | Bubbles not level for quadrant mount. | | |

d. Safety Certification

(1) **Record.** Units should keep a record of all safety certifications. The record should include the following:

- Name and rank
- Unit
- Position in which safety-certified
- Date of safety exam
- Date of certification
- Name of certifying officer
- Test scores

(2) **Statement.** Units should keep on file a statement signed by the certified individual indicating that he understands that-

- For every function connected with firing, there is a person responsible for doing it, and there is a safety-certified person responsible for seeing that it is done properly.
- The person checking data must be safety-certified himself.
- At no time may an individual perform a function related to firing and check himself.
- The individual understands his duties as a safety-certified person and will do his duties without compromise.

O-3. VERIFICATION CHECKLIST

The verification checklists presented below may be modified as necessary to meet local requirements.

PLATOON SERGEANT OR GUNNERY SERGEANT VERIFICATION CHECKS

1. Verify lay and referred deflections of weapons.
2. Verify sight to crest and distance to crest of weapons.
3. Verify posted safety limits of weapons.
4. Ensure azimuth of fire is verified with M2 compass on each howitzer.
5. Verify Boresight.

CHIEF OF SECTION VERIFICATION CHECKS

1. Verify the lay of the weapon as follows:
 - a. Lay deflection.
 - b. Referred deflection to the second circle and to the aiming points.
2. Verify sight to crest.
3. Verify boresight.
4. Verify that prefire checks have been performed.
5. Post safety limits when a safety T is received.
6. Before firing verify the following:
 - a. Shell-fuze combination and fuze setting.
 - b. Charge
 - c. Deflection and quadrant settings (bubbles level), and that the gunner has the correct sight picture.
 - d. Fire commands are safe to fire using the safety T.
 - e. The number of cut charges remaining.

GLOSSARY

| |
|----------|
| A |
|----------|

- AAP** allied administrative publication
- abatis** obstacle created by felling trees so that the trunks lie across a road or trail and impede movement.
- AC** aiming circle
- ACIF** artillery counterfire information
- ADAM** area denial artillery munitions
- ADFT** artillery direct fire trainer
- adjusting piece** the howitzer that is designated by FDC to conduct the adjust fire portion of a fire mission.
- advance party** a group of unit representatives dispatched to a planned new position in advance of the main body to prepare the position for the arrival of the unit and its equipment.
- AFATDS** advanced field artillery tactical data system
- AFCS** automatic fire control system
- AG** assistant gunner
- AIC** ammunition identification code
- aiming circle** an optical instrument used to orient the tube of an indirect fire weapon in a desired direction. This instrument can measure both the horizontal and vertical angles.
- aiming point** a sharply defined point or object on which the sight of a weapon is aligned when the weapon is laid for direction. There are two general types of aiming points--distant and close-in.
- aiming post** a striped rod used in pairs as a close-in aiming point.
- ALOC** administrative and logistics operations center
- alt** altitude
- alternate position** the position given to a weapon, unit, or individual to be occupied when the primary position becomes untenable or unsuitable for carrying out the mission. The alternate position is located so that the unit can continue the mission it had when in its primary position.
- AM** amplitude modulated
- AMB** air mission brief
- AMC** at my command
- ammunition lot number** code number assigned to a particular lot of ammunition when it is manufactured. This manufacturer's lot number is alphanumeric and is different from the lot number assigned to an ammunition lot by the unit.
- ammunition supply point** location at which conventional ammunition is available for distribution to using units.
- ammunition transfer point** location established in the maneuver brigade's trains area to issue high-usage conventional ammunition to using units.
- AMTP** ARTEP mission training plan
- ant** antenna
- AOF** azimuth of fire
- AOP** allied ordinance publication
- AP or APERS** antipersonnel
- AP-BAF** (memory aid) az to the aiming point minus back-azimuth of fire
- APERS-T** antipersonnel--tracer
- app** appendix
- AR** Army regulation
- area denial artillery munitions** projectiles M692 and M731 are 155-mm mine munitions containing 36 antipersonnel mines each.
- arming range** the range at which a fuze becomes operational.
- ARTEP** Army training and evaluation plan
- ARSS** automated range safety system
- ASP** ammunition supply point
- ATGM** antitank guided missile

ATP ammunition transfer point

automated range safety system a computer software application which allows for the automated computation of range safety data or safety Ts.

axis of tube imaginary center line of the tube of a cannon.

AXO assistant executive officer

a z azimuth

azimuth a horizontal, clockwise angle measured from north. A grid azimuth, measured from grid north, is the azimuth normally used in the field artillery. A magnetic azimuth is measured from magnetic north; a true azimuth is measured from true north.

azimuth of fire the direction, expressed in mils, that a battery is laid (oriented) on when it occupies a position.

B

back-azimuth the back-azimuth is equal to the azimuth plus or minus 3,200 mils.

BAS battalion aid station

base-ejection shell a type of projectile that ejects its payload from the base, such as the ICM projectile.

basic load of ammunition the amount of ammunition a unit is authorized to maintain to initiate combat and sustain itself until resupplied.

battery center the chart location of the battery. The geographic center of all weapons.

battery computer system an automated data processing system located in the firing battery. Consists of three major components: light-weight computer unit, power distribution unit, and 1 to 12 gun display units. Used to compute accurate firing data and as a digital communications interface. For additional information, see ST 6-40-2.

battery operations center a facility established to serve as an alternate FDC and as the battery command post.

BB basebleed

BC battery commander

BCS battery computer system

BD base detonating (fuze)

BDAR battlefield damage assessment and repair

BE Belgium or base ejecting

BG box grinder

BII basic issue item

BMO battalion motor officer

BMT battalion maintenance technician

bn battalion

BOC battery operations center

BOMREP bombing report

boresighting the process by which the optical axes of the weapon sights are aligned parallel to the axis of the cannon tube. The primary methods of boresighting are the distant aiming point, the testing target, or standard angle. Boresight is verified with the M140/M139 alignment device.

BSA brigade support area

BSOC battalion support operations center

btry battery

BUCS backup computer system

C

CA Canada or case assembly

cal caliber

caliber 1. The diameter of the bore of a weapon; obtained in rifled weapons by measuring between opposite lands. **2.** Diameter of a projectile. **3.** Unit of measure used to express the length of the bore of a weapon. The number of calibers is determined by dividing the length of the bore of the weapon (from breech face of the tube to the muzzle) by the diameter of its bore.

CAM chemical agent monitor

- CANCEL** a command which, when coupled with an order, rescinds that order. For example, CANCEL CHECK FIRING indicates the previous order to check firing is no longer in effect.
- CATV** combat ammunition transport vehicle
- CBR** chemical, biological and radiological
- CCL** combat-configured loads
- CEASE LOADING** a command that prohibits a section from loading another round.
- CECOM** Communications-Electronic Command
- CEP** circular error probable
- CF** command/fire (radio net)
- CFB** chief of firing battery
- CFST** critical fire support task
- chan** channel
- charge** the propellant of semifixed or separate-loading ammunition.
- CHECK FIRING** a command given to cause an immediate halt in firing.
- chg** charge
- close-in aiming point** an aiming point set up in the platoon area. The primary close-in aiming point is the infinity collimator, a lightweight optical instrument that simulates an aiming point at infinity. A secondary close-in aiming point is a set of two aiming posts. When aligned, the two posts establish a line along which the panoramic telescope is sighted when laying for direction.
- cmd** command (radio net)
- COB** center of battery
- collimator** an infinity reference device used as a close-in aiming point during indirect fire.
- comm** communications
- common deflection** the deflection corresponding to the azimuth of fire that the FDC has input into the BCS and BUCS. The common deflection for all weapons with an M100-series sight is 3200. For the M101A1 it is 2800.
- common grid** the extension of survey control (direction, location, and altitude) from a base datum to all fire support assets requiring orientation and positioning data within a command. Note that the USMC terminology is common survey.
- complete rounds** term that includes the various components of a round required to perform the firing function. There are four components in a complete round: a primer, a propellant, a projectile, and a fuze.
- comp \rightarrow site** complementary angle of site
- COMSEC** communications security
- continuous fire** fires delivered by loading and firing as rapidly as possible consistent with accuracy and within the prescribed rates of fire for the pieces.
- cookoff** functioning of chambered ammunition caused by the heat of the weapon rather than by normal firing.
- coppering** metal fouling left in the bore of a cannon by the rotating band of a projectile.
- corr** correction
- counterfire** fires directed against indirect-fire systems, to include their weapons, command and control, communications, ammunition, and target acquisition components.
- counterrecoil** forward motion of a cannon returning to firing (in-battery) position after recoil.
- CP** command post or concrete piercing (fuze)
- Cphd** Copperhead
- crater analysis** process by which the direction to an artillery or mortar unit is determined from analysis of the shell crater. Additionally, shell fragments are collected to determine the type of shell that caused the crater.
- crest** a terrain feature of such altitude that it limits the minimum elevation of a weapon.
- crew-served weapons** weapons, such as machine guns or howitzers, that require two or more persons to operate.
- CS** chlorobenzalmononitrile (riot control agent)
- CSL** chemical storage location
- CSS** combat service support

CUCV commercial utility cargo vehicle

D

D delay (fuze)

DA Denmark or Department of the Army

danger close field artillery fires delivered within 600 meters of friendly forces.

DAP distant aiming point

DC declination constant, or direct current

DCT digital communications terminal

declination constant the horizontal clockwise angle from grid north to magnetic north; the grid azimuth of magnetic north. The declination constant is recorded for every instrument equipped with a magnetic needle. The constant for any instrument will vary in different localities, and the constant of different instruments in the same locality will also vary. This variation is due to slight differences in manufacturing, to the shock from handling the instruments during normal use, and to the shift of magnetic north.

deflection the horizontal clockwise angle from the line of fire, or the rearward extension of the line of fire, to the line of sight of a designated aiming point with the vertex of the angle at the sight. In addition to deflection as a fire command, the firing battery is concerned with both common and referred deflection.

deliberate occupation the occupation of a position by a unit that has been fully prepared for occupation by the advance party; for example, howitzer positions have been selected and initial deflections provided to the gun guides.

destruction fire indirect fire delivered with the sole purpose of destroying material targets by massing fires. Each firing element may expend large quantities of ammunition to destroy the target.

df deflection

diam diameter

digital message device a small, portable, two-way communications terminal used by field artillery

observers to transmit and receive high speed digital messages. May communicate with IFSAS, TACFIRE, BCS, VMEDs, FEDs, DCTs or other DMDs through wire or standard army radios.

direct fire fire brought on a target utilizing direct laying techniques.

direct laying the aiming of a piece by sighting directly on the target.

dis distance

displacement 1. The act of leaving a position prior to occupying another. 2. The undesired movement of a sight caused by traversing the tube or by the shock of firing.

distant aiming point an aiming point at least 1,500 meters from the pieces.

distribution of fire the pattern of bursts in the target area; the sheaf.

div arty division artillery

DMD digital message device

DNL do not load

DODAC Department of Defense ammunition code

DODIC Department of Defense identification code

DPICM dual-purpose improved conventional munitions

DS direct support

DTG date-time group

DUD an explosive munition which has failed to function due to fuze or projectile malfunction, thus creating a potentially hazardous condition.

DZ drop zone

E

ED emergency destruction

EFC equivalent full charge

el elevation

emergency mission occupying a position, from the march, in response to a call for fire, without prior reconnaissance or preparation of the position.

EMP electromagnetic pulse

end of the orienting line a point on the orienting line marked by any sharply defined permanent or semipermanent object such as a steeple, flag-pole, or stake. It should be visible during darkness.

EOD explosive ordnance disposal

EOL end of the orienting line

EOM end of mission

EPW enemy prisoner of war

equivalent full charge the method used to determine the remaining life of a cannon tube. To convert to EFC rounds, the quantity of rounds fired is multiplied by the EFC factor as indicated in the weapon's technical manual. Computations are recorded on DA Form 2408-4, or NAVMC 1055A (gun book).

ET electronic time (fuze)

EW electronic warfare

F

F Fahrenheit

FA field artillery

family of scatterable mines a group of munitions or devices which contain scatterable mines delivered by aircraft, rocket, artillery, or vehicle. The artillery has four 155-mm projectiles, of which two (M692/M731) are area denial artillery munitions and two (M718/M741) are remotely activated antitank mines. The projectiles are ordered for either long or short self-destruct. The mode is not selected by the firing unit. Some of the mines are equipped with antisturbance devices.

FASCAM family of scatterable mines

FASP field artillery support plan

FAST forward area support team

FC field circular

FD fire direction (raido net)

FDC fire direction center

FDO fire direction officer

FEBA forward edge of the battle area

FED forward entry device

FFE fire for effect

final protective fire a continuous fire mission that creates a wall of steel to protect units in a defensive posture.

fire control alignment tests tests performed to determine if the on-carriage fire control equipment, the gunner's quadrant, and the alignment device are in correct adjustment.

Firefinder AN/TPQ-36 mortar-locating radar, or AN/TPQ-37 artillery-locating radar.

fire support team in fire support operations, a team made up of a team chief (FA lieutenant) and the additional personnel and equipment required to request, coordinate, and direct fire support efforts for company-size maneuver units.

1SG first sergeant

FIST fire support team

FLOT forward line of own troops

FLS forward landing strip

FM frequency modulated, field manual

FOM figure of merit

forcing cone tapered beginning of the lands of the rifling of a cannon tube. The forcing cone allows the rotating band of the projectile to be gradually engaged by the rifling, thereby centering the projectile in the bore.

formations weapons emplacement in position area as selected by the gunnery sergeant.

forward entry device a lightweight digital data communications device which replaces the DMD.

FPF final protective fires

FPL final protective line

FR France

fratricide firing of a weapon which results in the unintended or inadvertent injury or death of allied or friendly personnel.

FRTTP flat rack transfer point

FS fire support or fuze setting

FSB forward support battalion
FSC Federal supply classification
FSCOORD fire support coordinator
FSE fire support element
FSN Federal stock number
FT firing tables
fz fuze

G

GA gun assembly
GB green bag
GDU gun display unit (BCS)
GE Germany
GFT graphical firing table
GLPS gun laying and positioning system
G-M grid magnetic
GN grid north
GPS global positioning system
GQ gunner's quadrant
GR Greece
grid declination the smaller angle between true north and grid north. Grid declination is indicated in the marginal data of maps as east or west of true north.
grid north the north direction of the vertical grid lines on a military map, a photomap, or a grid sheet. Since determination of firing data for direction is based on grid north, the term *azimuth* normally means grid azimuth.
GSG gunnery sergeant
GST graphical site table
gun display unit digital display unit on the howitzer that will receive and display firing data computed and transmitted by the BCS in the FDC. The GDU consists of a section chief's assembly, two gun assemblies, and the case assembly.
gun laying and positioning system a tripod-mounted positioning and orienting device which uses

global positioning system (GPS) and a laser range finder to allow precise laying of howitzers. GLPS eliminates the need for external survey.

gunner's reference card DA Form 5212-R, which is used to record essential mission data and referred deflections given aiming points.

H

H blister agent (mustard)
HA high angle
hangfire temporary failure or delay in the action of a primer, an igniter, or a propelling charge.
hasty occupation the occupation of a position that has not been fully prepared for occupation by the advance party.
hasty survey techniques used to establish rapid and sufficiently accurate direction and/or position data through simplified procedures and with cannon battery TOE equipment. See Chapter 5 for detailed procedures.
HC hexachloroethane (smoke)
hdst headset
HE high explosive
HEAT high-explosive antitank
HEAT-T high-explosive antitank--tracer
heavy artillery more than 160-mm bore.
HEDP high explosive dual purpose
HEMAT heavy expanded-mobility ammunition trailer
HEMTT heavy expanded-mobility tactical truck
HEP high-explosive plastic
HEP-T high-explosive plastic--tracer
HERA high-explosive rocket-assisted
HMMWV high-mobility multipurpose wheeled vehicle
horiz horizontal
hot section a cannon section designated to maintain full crews at their posts for instant reaction to a fire mission. This technique minimizes

reaction time to calls for fire and allows the other section to accomplish the various tasks that must be done during position improvement.

- how** howitzer
- howitzer** a field artillery weapon characterized by a medium length barrel (between that of a mortar and a gun), a relatively high angle of fire, and a medium muzzle velocity.
- HP** hydropneumatic
- HPC** hydropneumatic constant
- HPV** hydropneumatic variable
- HSW** horizontal sliding wedge
- HUMINT** human intelligence

I

- IAW** in accordance with
- ICM** improved conventional munitions
- IFF** identification, friend or foe
- IFP** individual fighting position
- IFSAS** initial fire support automated system
- illum** illumination
- IMINT** imagery intelligence
- immediate suppression** field artillery fires required when the enemy has freed from, or has been firing and can fire from, a given location such that direct fire weapons and supporting field artillery must respond instantaneously.
- initial fire support automated system** a tactical fire direction computer system which replaces the older TACFIRE.
- indirect laying** the aiming of a piece by sighting at an aiming point other than the target. The piece is laid for direction by setting a given deflection on the sight and traversing the tube until the line of sight of the panoramic telescope is on the aiming point. The piece is laid for elevation on the range quadrant or gunner's quadrant by elevating or depressing the tube until the appropriate bubble is centered.
- instrument reading** the horizontal clockwise angle from the line of fire to magnetic north.

intermediate crest a crest lying between the firing position and the target that is not visible from the firing position.

- IOC** initial operational capability
- IPB** intelligence preparation of the battlefield
- IPRTF** in place ready to fire
- IR** instrument reading
- IT** Italy
- ITS** individual training standards

J

jamming the intentional transmission of interfering electronic signals in order to disrupt the reception of other signals.

- JCS** Joint Chiefs of Staff

K

- kg** kilogram
- km** kilometer
- KOK** cryptographic operational keying device

L

- L** left or long duration (suffix with ADAMS or RAAMS)
- laid** a weapon is laid when the axis of the tube is accurately aimed in a predetermined direction.
- lands** the raised portion between the grooves in the bore of a rifled cannon tube. Spiral channels cut in the bore of the cannon tube are the grooves. These (in conjunction with the rotating band) impart spin on the projectile.
- LARS** left, add; right, subtract
- LAW** light antitank weapon (M72A2 or AT4)
- laying** the process of orienting a weapon for direction.
- LCU** lightweight computer unit
- LED** light emitting diode
- LIC** low-intensity conflict

lightweight computer unit the AN/GYK-37 field artillery fire direction computer. Replaces the BCU as the computer component of the BCS.

line of fire the direction of the line established by the tube or any line parallel to that line in the firing battery. It is an imaginary line extending through the central axis of the tube when looking through the breech to the muzzle of the weapon

LOF line of fire

LOGPAC logistics package

LP listening post

LRP logistics release point

LU Luxembourg

LZ landing zone

M

m meter

mil mil

MA muzzle action

magnetic declination the smaller angle between true north and magnetic north. This angle is indicated in the marginal data of maps as east or west of true north. Since the magnetic declination varies slightly from year to year, a correction factor (the annual magnetic changes) is also shown in the marginal data of military maps.

magnetic north the direction to the magnetic North Pole.

MAMT muzzle action, mechanical time (fuze)

MAPMOD map modification (mnemonic)

max maximum

MCCRES Marine Corps combat readiness evaluation system

medium artillery 120-mm through 160-mm bore

met meteorology

METTAL (memory aid) mission, enemy, terrain and weather, troops available, aircraft available, load requirements

METT-T mission, enemy, terrain, troops, and time

MG machine gun

MHE materials handling equipment

MHL manufacturer's hairline

mil a unit of measurement for angles. There are 6,400 mils in a complete circle.

min minimum

minimum quadrant elevation 1. The lowest quadrant elevation of a weapon at which the projectile will safely clear an obstacle between the weapon and the target. **2.** The lowest quadrant elevation of a weapon at which the projectile will reach the minimum range line of an impact area before detonation.

min QE minimum quadrant elevation

mod modified

MOFA multiple option fuze artillery

MOPP mission-oriented protection posture

MORTREP mortar bombing report

MRE meal, ready to eat

MSR main supply route

MST minimum safe time

MT mechanical time

MTOE modification tables of organization and equipment

MTP mission training plan

MTSQ mechanical time superquick

MV muzzle velocity

mvr maneuver

MVV muzzle velocity variation

MWO modification work order

N

NATO North Atlantic Treaty Organization

NBC nuclear, biological, chemical

NCA National Command Authority

NCO noncommissioned officer

NCOIC noncommissioned officer in charge (of)

NCS net control station

ND nondelay (fuze)
NEO noncombatant evacuation operations
NET no earlier than
NFA no-fire area
NFL rule memory aid for correcting displacement when using aiming posts. The near post, far post, and pantel line are an equal number of mils apart.
NICAD nickel-cadmium
NIIN national item identification number
NL Netherlands
NLT no later than
NO Norway
NSN national stock number

O

OA orienting angle
O&I operations and intelligence
OD olive drab
OEG operational exposure guide
OIC officer in charge
OL orienting line
OOTW operations other than war
OP observation post
OPORD operation order
OPSEC operations security
orienting angle a horizontal clockwise angle from the line of fire to the orienting line.
orienting line a line of known direction in the battery area that serves as a basis for laying the battery for direction. The azimuth of the orienting line is the direction from the orienting station to a designated end of the orienting line.
orienting station a point established on the ground which has directional control. The aiming

circle is set up over this point to lay the pieces by the orienting angle method.

ORSTA orienting station (BCS or BUCS mnemonic)
ORSTB second orienting station (BCS or BUCS mnemonic)
OS orienting station

P

PADS position and azimuth determining system
pam pamphlet
panoramic telescope (usually called the sight or pantel) a fire control instrument used for either direct or indirect fire. Panoramic telescopes used on current field artillery weapons are as shown below.

| WEAPON | SERIES | MAXIMUM DF | COMMON DF |
|-----------|--------|------------|-----------|
| M101A1/A2 | M12 | 3200 | 2800 |
| M119A1 | M100 | 6400 | 3200 |
| M102 | M100 | 6400 | 3200 |
| M109A2-A6 | M100 | 6400 | 3200 |
| M110A2 | M100 | 6400 | 3200 |
| M198 | M100 | 6400 | 3200 |

pantel panoramic telescope
PCC precombat check
PCI precombat inspection
PCR piece-to-crest range
PD point detonating (fuze)
PDF primary direction of fire
PDU power distribution unit
PH percussion hammer
platoon leader is the tactical commander of the firing platoon.
platoon sergeant the primary enlisted assistant to the platoon leader. He must be prepared to assume all of the platoon leaders duties.
PLAY (memory aid) pantel lays you
PLGR precise lightweight global positioning system receiver

PL platoon leader
PLL prescribed load list
PLS palletized load system
PSG platoon sergeant
PMCS preventive maintenance checks and services
pneu pneumatic
PO Portugal
POC platoon operations center
POL petroleum, oils and lubricants
PPS precise positioning system
primary position the position from which a battery intends to perform its assigned mission.
priority target a target that firing units lay on while not engaged in a fire mission. It is designated as critical by a maneuver commander on the basis of type, location, or time sensitivity. Generally, one battery will be laid on each priority target (as with an FPF).
prox proximity (fuze)
PSG platoon sergeant
PSYOPS psychological operations
PTF pieces to fire
PTO power takeoff
pub publication
PZ pickup zone

Q

Q quick (fuze)
QE quadrant elevation
QSTAG quadripartite standardization agreement

R

R right
R3P rearm, refuel, resupply point
RAAMS remote antiarmor mine system
RALS right, add, left, subtract

RAP rocket-assisted projectile
RC rounds complete (BCS)
RDF radio direction finding
rd/min rounds per minute
RDP range-deflection protractor
rearward extension of the line of fire an imaginary line extending through the center axis of the tube when looking down through the muzzle to the breech of the weapon. The rearward extension of the line of fire is a line in the exact opposite direction of the line of fire.
REC radio electronic combat
recoil rearward motion of a weapon caused by firing.
refer to measure (using the panoramic telescope) the deflection to a given aiming point without moving the tube. In some instances, this referred deflection will be reported. If it is desired that it be recorded, the command RECORD REFERRED DEFLECTION is announced.
referred deflection the deflection measured to an aiming point without moving the tube of the weapon.
registering piece the howitzer that is designated by FDC to conduct a registration fire mission.
remote antiarmor mine system M718/M741 projectile containing nine antitank mines. The M718 and M741 projectiles are equipped with a long and a short self-destruct capability respectively.
rg range
RJ road junction
ROCKREP rocketing report
ROE rules of engagement
ROM read-only memory
RP release point
RPG rocket-propelled grenade
rpm revolutions per minute
RSOP reconnaissance, selection, and occupation of position

S

S series or short duration (suffix with ADAM and RAAMS)

SAD (memory aid) subtract the azimuth of fire from the declination constant

SAM (memory aid) subtract the azimuth of fire from the measured azimuth

SCA section chiefs assembly (GDU)

SCP survey control point

SEAD suppression of enemy air defense

sec second

sheaf the lateral distribution of the bursts of two or more pieces fired together. The width of the sheaf is the lateral distance (perpendicular to the direction of fire) between the centers of flank bursts. A sheaf may be formed in any of the following patterns: converged, open, parallel, or special.

SHELREP shelling report

SHORAD short-range air defense

si site

SID (memory aid) subtract the instrument reading from the declination constant

SIGINT signals intelligence

SIGSEC signals security

SIMO simultaneous observation

SINCGARS single-channel ground and airborne radio system

SIP spring-actuated, inertia percussion

SITREP situation report

SM soldier's manual

small unit transceiver a short-range FM radio designed to supplement the intrabattery wire system and to enhance command and control of marches and movements.

smk smoke

SOI signal operation instructions

SOL (memory aid) subtract the orienting angle from the orienting line

SOP standing operating procedures

SP start point or self-propelled

spoil refuse removed in the process of digging

spt support

SQ superquick

square in artillery, a mark or measurement on projectiles to denote standard weight or deviation from a standard weight,

SR self-registration

STANAG standardization agreement

STIS stepped thread, interrupted screw

STP soldier's training publication

supplementary position a position selected for accomplishment of a specific mission other than the primary mission.

SUT small-unit transceiver

T

T tracer

TACFIRE tactical fire direction system

tan tangent

T&E traverse and elevation

TASC Training and Audiovisual Support Center

TB technical bulletin

TBD to be determined

TC training circular or track commander

TEC training extension course

TFOOL (memory aid) take the azimuth of fire out of the orienting line

TFT tabular firing tables

TGPC terrain gun positioning correction

tgt target

ti time

TIP telescope in place

TIS thread interrupted screw

TLABSPAP (memory aid) trails, spades, and/or firing platform properly emplaced, lay weapon; aiming point emplaced; boresight verified or performed; second circle; prefire checks on the weapon system performed; ammunition prepared; position improvement

TLP troop leading procedure

TM technical manual

TOC tactical operations center

TOE tables of organization and equipment

TOF time of flight

TOT time on target

TOW tube-launched, optically tracked, wire-guided missile

TRADOC US Army Training and Doctrine Command

TRALS (memory aid) true on right, add; left, subtract

TRP target reference point

TSFO training set, fire observation

TU Turkey

two step deflection method 1. Set off the announced deflection on the panel using the reset counter scale. **2.** Traverses the weapon until line of sight is back on the aiming point.

U

UBL unit basic load

UK United Kingdom

US United States

USAF United States Air Force

USAFAS United States Army Field Artillery School

USMC United States Marine Corps

UTM universal transverse mercator

V

VA vertical angle

VE velocity error

vertical angle the angle measured vertically up or down from a horizontal plane or reference. The vertical angle is expressed as plus or minus depending on whether the position is above (plus) or below (minus) the horizontal plane.

vertical interval the difference in height between the weapon and the desired burst point.

VFMED variable format message entry device

VI vertical interval

vol volume

VSW vertical sliding wedge

VT variable time (fuze)

W

WARNO warning order

WB white bag

WP white phosphorus

WR when ready

WSRO weapon system replacement operations

wt weight

X

XO executive officer

SECTION CHIEF'S REPORT

(For 105-mm, 155-mm, and 203-mm Howitzers)

For use of this form, see FM 6-50. The proponent agency is TRADOC.

GENERAL DATA

| | | | | | |
|------------------------------|-----------------|--------------------------------|-----------------|------------------------|--------|
| DTG | HOWITZER NUMBER | BUMPER NUMBER | AZIMUTH OF FIRE | LAY DF | METERS |
| SITE TO CREST MILS | | PIECE-TO-CREST RANGE METERS | | NATURE OF CREST DF | |
| SITE TO CREST MILS | | PIECE-TO-CREST RANGE METERS | | NATURE OF CREST DF | |
| SITE TO CREST MILS | | PIECE-TO-CREST RANGE METERS | | NATURE OF CREST DF | |
| MIN QE | MAX QE | LEFT DF LIMIT | RIGHT DF LIMIT | PROPELLANT TEMPERATURE | |
| SENSITIVE ITEMS YES or NO | | | | | |

PART I. AMMUNITION STATUS FOR 105-MM HOWITZERS

| PROJECTILES | | | FUZES | |
|-------------|--------------------------|-----|-------|------|
| HE | <input type="checkbox"/> | LOT | M557 | M739 |
| | <input type="checkbox"/> | LOT | | |
| WP | <input type="checkbox"/> | LOT | M78 | M564 |
| | <input type="checkbox"/> | LOT | | |
| HC | <input type="checkbox"/> | LOT | M565 | M577 |
| | <input type="checkbox"/> | LOT | | |
| RAP | <input type="checkbox"/> | LOT | M728 | M582 |
| | <input type="checkbox"/> | LOT | | |
| ICM | <input type="checkbox"/> | LOT | M732 | |
| | <input type="checkbox"/> | LOT | | |
| ILLUM | <input type="checkbox"/> | LOT | | |
| | <input type="checkbox"/> | LOT | | |

REMARKS

PART II. AMMUNITION STATUS FOR 155-MM HOWITZERS

| PROJECTILES | | | PROPELLANTS | | FUZES | |
|---------------------|--------------------------|-----|-----------------------|-----|---------|------|
| HE | <input type="checkbox"/> | LOT | M3A1 GREEN BAG | | M577 | M565 |
| | <input type="checkbox"/> | LOT | LOT | LOT | | |
| WP [M110] | <input type="checkbox"/> | LOT | M4A2 WHITE BAG | | M564 | M739 |
| | <input type="checkbox"/> | LOT | LOT | LOT | | |
| HC | <input type="checkbox"/> | LOT | M119A1 CHG 8 WB | | M582 | M732 |
| | <input type="checkbox"/> | LOT | LOT | LOT | | |
| RAP | <input type="checkbox"/> | LOT | M119A2 CHG 7 RED BAG | | M728 | M577 |
| | <input type="checkbox"/> | LOT | LOT | LOT | | |
| ICM | <input type="checkbox"/> | LOT | M203 CHG 8S RED BAG | | | |
| | <input type="checkbox"/> | LOT | LOT | LOT | | |
| DPICM | <input type="checkbox"/> | LOT | M203A1 CHG 8S RED BAG | | PRIMERS | |
| | <input type="checkbox"/> | LOT | LOT | LOT | M82 | |
| ADAM | <input type="checkbox"/> | LOT | ILLUM | | | |
| | <input type="checkbox"/> | LOT | LOT | LOT | | |
| RAAMS | <input type="checkbox"/> | LOT | REMARKS | | | |
| | <input type="checkbox"/> | LOT | | | | |
| SMK WP [M825] | <input type="checkbox"/> | LOT | | | | |
| | <input type="checkbox"/> | LOT | | | | |

PART III. AMMUNITION STATUS FOR 203-MM HOWITZERS

| PROJECTILES | | | PROPELLANTS | | FUZES | |
|-------------|--------------------------|-----|------------------------------|-----|---------|------|
| HE | <input type="checkbox"/> | LOT | M1 GREEN BAG | | M557 | M739 |
| | <input type="checkbox"/> | LOT | LOT | LOT | | |
| RAP | <input type="checkbox"/> | LOT | M2 WHITE BAG | | M564 | M565 |
| | <input type="checkbox"/> | LOT | LOT | LOT | | |
| ICM | <input type="checkbox"/> | LOT | M188 CHG 8 WHITE BAG | | M577 | M582 |
| | <input type="checkbox"/> | LOT | LOT | LOT | | |
| DPICM | <input type="checkbox"/> | LOT | M188A1 CHG 8 AND 9 WHITE BAG | | M728 | M732 |
| | <input type="checkbox"/> | LOT | LOT | LOT | | |
| REMARKS | | | | | PRIMERS | |
| | | | | | M82 | |
| | | | | | | |

GUNNER'S REFERENCE CARD

For use of this form, see FM 6-50. The proponent agency is TRADOC.

AZ OF LAY

DF TO AC

DIST TO AC

DF TO COLL

DF TO SAFETY CIR

DF TO AP

DF TO DAP

RIGHT LIMITS

MAX QE

LEFT LIMITS

MIN QE

STANDARDS

ADJ PIECE

SHELL

LOT

FZ

PRIORITY TARGETS

| PRIORITY | TGT DESIG | SP INSTR | RDS | SH | LOT | CHG | FZ | TI | DF | QE |
|----------|-----------|----------|-----|----|-----|-----|----|----|----|----|
| | | | | | | | | | | |
| | | | | | | | | | | |
| | | | | | | | | | | |

POSITION CORRECTIONS

| SECTOR | DF CORR | QE CORR | FS CORR |
|------------------|---------|---------|---------|
| PRIMARY | | | |
| RIGHT | | | |
| LEFT | | | |
| CONVERGED | | | |

WEAPON LOCATION DATA

For use of this form, see FM 6-50. The proponent agency is TRADOC.

ORIENTING STATION

EASTING _____

NORTHING _____

ALTITUDE _____

AZIMUTH OF FIRE _____

| HOWITZER NUMBER | METHOD OF LAY | DEFLECTION | AZIMUTH TO HOWITZER ¹ | DISTANCE (METERS) | VERTICAL ANGLE (MILS) | GRID |
|-----------------|---------------|------------|----------------------------------|-------------------|-----------------------|------|
| 1 | | | | | | |
| 2 | | | | | | |
| 3 | | | | | | |
| 4 | | | | | | |
| 5 | | | | | | |
| 6 | | | | | | |
| 7 | | | | | | |
| 8 | | | | | | |

¹AOF + DF = AZ TO HOW
 ADD 3200 IF RED NUMBER IS USED (M12 ONLY)
 SUBTRACT 6400 IF SUM EXCEEDS 6400

HOWITZER RANGE CARD

For use of this form, see FM 6-50. The proponent agency is TRADOC.



SECTOR OF FIRE

LEFT DF

RIGHT DF

| NO. | SHELL | CHG | FZ | TI | DF | QE | RANGE | DESCRIPTION | REMARKS |
|-----|-------|-----|----|----|----|----|-------|-------------|---------|
| 1 | | | | | | | | | |
| 2 | | | | | | | | | |
| 3 | | | | | | | | | |
| 4 | | | | | | | | | |
| 5 | | | | | | | | | |

REFERENCES

SOURCES USED

These are the sources quoted or paraphrased in this publication.

AR 385-63. *Policies and Procedures for Firing Ammunition for Training, Target Practice, and Combat.* 15 October 1983.

FM 101-5-1. *Operational Terms and Symbols.* 21 October 1985.

Ott, General David E. *Vietnam Studies, Field Artillery, 1954-1973.* Washington, DC: US Government Printing Office. 1975.

STANAG 2934 Chapter 13/QSTAG 503. *Bombing, Shelling, Mortaring, and Location Reports.* 20 June 1989/30 August 1994.

STANAG 2041/QSTAG 520. *Operational Orders, Tables and Graphs for Road Movement.* 1 August 1980/25 August 1981.

STANAG 2047/QSTAG 183. *Emergency Alarms of Hazard or Attack (NBC and Air Attack Only).* 27 March 1985/14 August 1991.

STANAG 2113. *Denial of a Unit's Military Equipment and Supplies to an Enemy.* 15 December 1989.

STANAG 2154/QSTAG 539. *Regulations for Military Motor Vehicle Movement by Road.* 19 October 1987/2 October 1980.

TC 24-20. *Tactical Wire and Cable Techniques.* 3 October 1988.

TM 9-1300-206. *Ammunition and Explosives Standards.* 30 August 1973.

TM 9-1300-251-20. *Organizational Maintenance Manual (Including Repair Parts and Special Tools List): Artillery Ammunition for Guns, Howitzers, Mortars, Recoilless Rifles, and 40-mm Grenade Launchers.* 21 December 1973.

TM 11-7440-283-12-2. *Operator's and Organizational Maintenance Manual for Data Display Groups, Gun Direction, OD-144(V)/GYK-29(V).* 27 September 1982.

TM 43-0001-28. *Army Ammunition Data Sheets for Artillery Ammunition: Guns, Howitzers, Mortars, Recoilless Rifles, Grenade Launchers, and Artillery Fuzes (FSC 1310, 1315, 1320, 1390).* 28 April 1994.

DOCUMENTS NEEDED

These documents must be available for the intended users of this publication.

ARTEP 6-127-30-MTP. *Mission Training Plan for the Cannon Firing Battery 105mm, Towed.* 24 January 1990.

ARTEP 6-167-30-MTP. *Mission Training Plan for the Cannon Firing Battery (3x6), 155mm, Towed M198.* 13 November 1991.

ARTEP 6-367-20-MTP. *Mission Training Plan for the Cannon Firing Battery Firing platoon 155mm, Self Propelled and Towed.* 20 December 1990.

DA Form 581. *Request for Issue and Turn-In of Ammunition.* August 1989.

DA Form 2028. *Recommended Changes to Publications and Blank Forms.* February 1974.

DA Form 2185-R. *Artillery Counterfire Information.* April 1990.

DA Form 2404. *Equipment Inspection and Maintenance Worksheet.* April 1979.

DA Form 2406. *Material Condition Status Report.* April 1993.

DA Form 2407. *Maintenance Request.* August 1988.

DA Form 2408. *Equipment Log Assembly (Records).* November 1991.

DA Form 2408-4. *Weapon Record Data.* January 1979.

DA Form 2408-14. *Uncorrected Fault Record.* October 1991.

DA Form 4504. *Record of Fire.* October 1978.

DA Form 4513. *Record of Missions Fired.* May 1976.

DA Form 5212-R. *Gunner's Reference Card.* May 1983.

DA Form 5517-R. *Standard Range Card.* February 1986.

DA Form 5698-R. *Weapons Location Data.* August 1988.

DA Form 5699-R. *Howitzer Range Card.* August 1988.

DA Form 5969-R. *Section Chiefs Report.* October 1990.

DA Pam 25-30. *Consolidated Index of Army Publications and Blank Forms.* 1 October 1993.

DA Pam 710-2-1. *Using Unit Supply System (Manual Procedures).* 1 January 1982.

DA Pam 738-750. *The Army Maintenance Management System (TAMMS).* 27 September 1991.

STP 6-13B14-SM-TG. *Soldier's Manual and Trainer's Guide: 13B, Cannon Crew Member.* 15 August 1989.

TM 9-1015-203-12. *Operator/Crew and Organizational Maintenance Manual for Howitzer, Light; Towed 105-mm, M101A1 (NSN 1015-00-322-9752).* 21 April 1993.

TM 9-1015-234-10. *Operator's Maintenance Manual for Howitzer, Light, Towed: 105-mm, M102 (NSN 1015-00-086-8164).* 19 August 1985.

TM 9-1015-252-10. *Operators Manual for Howitzer, Light, Towed 105mm, M119A1.* 5 October 1992.

TM 9-1025-211-10. *Operator's Manual (Crew) for Howitzer, Medium, Towed: 155-mm, M198 (NSN 1025-01-026-6648).* 14 January 1991.

TM 9-2350-267-10. *Operators Manual for Carrier, Ammunition, Tracked: M992 (NSN 2350-01-110-4660).* 4 October 1991.

TM 9-2350-311-10. *Operator's Manual for Howitzers, Medium, Self-Propelled: 155-mm, M109A2, M109A3, M109A4, and M109A5.* 27 June 1986.

RECOMMENDED READING

These readings contain relevant supplemental information.

AAP-6. *NATO Glossary of Terms and Definitions* March 1986.

Note: AAP-6 can be obtained from NATO Terminology Coordinator, Military Agency for Standardization (MAS), NATO Headquarters, B.110 Brussels, Belgium.

AOP-6. *Land Forces Ammunition Interchangeability Catalogue in Wartime.* May 1989.

Note: AOP-6 can be obtained from Logistics Specialist, TRADOC Munitions System Managers, USAOMMCS, ATTN: ATSK-Z, Redstone Arsenal, AL 35897-6095.

AR 75-1. *Malfunctions Involving Ammunition and Explosives.* 1 March 1989.

AR 310-25. *Dictionary of United States Army Terms.* 15 October 1983.

AR 310-50. *Authorized Abbreviations and Brevity Codes.* 15 November 1985.

AR 380-5. *Department of the Army Information Security Program.* 25 February 1988.

AR 380-19. *Department of the Army Information System Security Program.* 1 August 1990.

AR 672-5-1. *Military Awards.* 12 April 1984.

AR 750-1. *Army Material Maintenance Policy and Retail Maintenance Operations.* 11 March 1988.

DST-1160G-029-85. *Projectile Fragment Identification Guide.* 27 January 1989.

Note: DST-1160G-029-85 can be obtained from Foreign Science and Technology Center, ATTN: AIA-IPD, US Army Intelligence Agency, Washington DC 20310-1015.

FM 3-4. *NBC Protection.* 29 May 1992.

FM 3-5. *NBC Decontamination.* 23 July 1992.

(C) FM 3-10B. *Employment of Chemical Agents(U).* 30 November 1966.

FM 3-100. *NBC Operations.* 23 May 1991.

FM 5-25. *Explosives and Demolitions.* 15 June 1992.

FM 5-103. *Survivability.* 10 June 1985.

FM 6-2. *Tactics, Techniques, and Procedures for Field Artillery Survey.* 23 September 1993.

FM 6-15. *Tactics, Techniques, and Procedures for Field Artillery Meteorology.* 18 June 1992.

FM 6-20. *Fire Support in the AirLand Battle.* 17 May 1988.

FM 6-20-1. *Tactics, Techniques, and Procedures for the Field Artillery Cannon Battalion.* 29 November 1990.

FM 6-20-2. *Tactics, Techniques, and Procedures for Corps Artillery, Division Artillery, and Field Artillery Brigade Headquarters.* 7 January 1993.

FM 6-30. *Tactics, Techniques, and Procedures for Observed Fire Procedures.* 16 July 1991.

- FM 6-40.** *Tactics, Techniques, and Procedures for Field Artillery Manual Cannon Gunnery.* 26 August 1994.
- FM 6-121.** *Tactics, Techniques, and Procedures for Field Artillery Target Acquisition.* 25 September 1990.
- FM 7-7.** *The Mechanized Infantry Platoon and Squad (APC).* 15 March 1985.
- FM 7-7J.** *The Mechanized Infantry Platoon and Squad (Bradley).* 7 May 1993.
- FM 9-6.** *Ammunition Service in the Theater of Operations.* 1 September 1989.
- FM 10-63.** *Handling of Deceased Personnel in Theaters of Operations.* AFM 143-3/FMFM 4-8. 28 February 1986.
- FM 11-50.** *Combat Communications Within the Division.* 4 April 1991.
- FM 19-25.** *Military Police Traffic Operations.* 30 September 1977.
- FM 19-30.** *Physical Security.* 1 March 1979.
- FM 20-22.** *Vehicle Recovery Operations.* 18 September 1990.
- FM 21-26.** *Map Reading and Land Navigation.* 7 May 1993.
- FM 21-60.** *Visual Signals.* 30 September 1987.
- FM 23-9.** *M16A1 Rifle and M16A2 Rifle Marksmanship.* 3 July 1989.
- FM 23-23.** *Antipersonnel Mine M18A1 and M18 (CLAYMORE).* 6 January 1966.
- FM 23-25.** *Launcher and Cartridge 84mm M136 (AT4) HEAT.* 22 November 1988.
- FM 23-31.** *40mm Grenade Launchers M203 and M79.* 1 May 1972.
- FM 23-33.** *66-mm Heat Rocket, M72A1, M72A2 (Light Antitank Weapon).* 20 April 1979.
- FM 23-65.** *Browning Machine Gun, Caliber .50 HB, M2.* 19 June 1991.
- FM 23-67.** *Machine Gun 7.62-mm, M60.* 29 February 1984.
- FM 24-1.** *Signal Support in the AirLand Battle.* 15 October 1990.
- (S) FM 34-40.** *Electronic Warfare operations (U).* 9 October 1987.
- FM 44-1.** *US Army air Defense Artillery Employment.* 9 May 1983.
- (S) FM 44-1A.** *Air defense Artillery Operational Planning Data (U).* 9 May 1983.
- FM 44-3.** *Air defense Artillery Employment: Chaparral/Vulcan/Stinger.* 15 June 1984.
- FM 44-18.** *Air Defense Artillery Employment, Stinger.* 30 September 1981.
- FM 55 Series.** *Transportation.*
- FM 55-9.** *Unit Air Movement Plan.* 5 April 1993.
- FM 55-12.** *Movement of Units in Air force Aircraft. AFM 76-6/FMFM 4-6/OPNA VINST 4630.27A.* 10 November 1989.
- FM 55-15.** *Transportation Reference Data.* 9 June 1986.
- FM 55-30.** *Army Motor Transport Units and Operations.* 14 March 1980.
- FM 55-450-2.** *Army Helicopter Internal Load Operations.* 5 June 1992.
- FM 55-450-3.** *Multiservice Helicopter External Air Transport Basic Operations and Equipment.* 11 February 1991.
- FM 90-3.** *Desert Operations (FMFM 7-27).* 24 August 1993.
- FM 90-4.** *Air Assault Operations.* 16 March 1987.
- FM 90-10(HTF).** *Military Operations on Urbanized Terrain (MOUT).* 15 August 1979.
- FM 90-13.** *River Crossing Operations (FMFM 7-26).* 30 September 1992.
- FM 100-2-1.** *Soviet Army Operations and Tactics.* 16 July 1984.
- FM 100-5.** *Operations.* 14 June 1993.
- FM 100-27.** *US Army/US Air Force Doctrine for Joint Airborne and Tactical Airlift Operations.* AFM 2-50. 31 January 1985.
- FM 101-10 Series.** *Staff Officer's Field Manuals.*
- FM 101-10-1.** *Staff Officer's Field Manual: Organizational, Technical, and Logistical Data (Unclassified Data).* 7 October 1987.
- FM 101-60-2.** *(C) Joint Munitions Effectiveness Manual, Surface to Surface (JMEM/SS) Effectiveness Data For Howitzer, 105mm, M101A1 (FMFM 4-7D-1).* 8 March 1978.
- FM 101-60-24.** *(C) Joint munitions Effectiveness Manual, Surface to Surface (JMEM/SS) Effectiveness Data For Howitzer, 8 inch, M110A2 (FMFM 4-7D-8).* 1 May 1984.

FM 101-60-25. (S/NOFORN) *Joint Munitions Effectiveness Manual, Surface to Surface (JMEM/SS) Effectiveness Data For Howitzers, 155mm M198, and M109A2/A3* (FMFM 4-7D-9). 1 September 1984.

(C) FM 101-60-29. *Joint Munitions Effectiveness Manual, Surface to Surface (JMEM/SS) Electiveness Data For Howitzers, 105mm, M102, and M119* (FMFM 4-7D-12) (U). 30 May 1986.

Note: These JMEMs may be obtained through S-2 channels from S&I Director USA Materiel Systems Analysis Activity, ATTN: AMXSY-J, Aberdeen Proving Grounds, MD 21005-5071.

FMFM 6-9. *Marine Artillery Support.* 29 June 1993.

FMFM 6-18. *Techniques and Procedures for Fire Support Coordination.* 27 March 1992.

FMFM 6-18-1. *Marine Corps Fire Support System Techniques and Procedures.* 5 October 1994.

NWP 22-2/FMFM 1-7. *Supporting Arms in Amphibious Operations.*

STANAG 1059. *National Distinguishing Letters for Use by NATO Armed Forces.* 6 December 1988.

STANAG 2002/QSTAG 501. *Warning Signs for the marking of Contaminated or Dangerous Land Areas, Complete Equipments, Supplies, and Stores.* 26 November 1980/28 September 1979.

STANAG 2019/QSTAG 509. *Military Symbols for Land Based Systems.* 16 September 1986/5 March 1979.

STANAG 2021/QSTAG 180. *Computation of Bridge, Ferry, Raft, and Vehicle Classifications.* 18 August 1990/12 August 1991

STANAG 2025/QSTAG 591. *Basic Military Road Traffic Regulations.* 1 October 1986/16 February 1989.

STANAG 2103/QSTAG 187. *Reporting Nuclear Detonations, Biological and Chemical attacks, and Predicting and Warning of Associated Hazards and Hazard Areas (ATP-45).* 31 October 1994/15 July 1987.

STANAG 2155. *Road Movement Bid and Credit.* 26 August 1994.

STANAG 2174/QSTAG 507. *Military Routes and Route/Road Networks.* 25 February 1994/12 December 1980.

STANAG 2176. *Procedure for Military Road Movements Across National Frontiers.* 27 April 1981

Note: STANAGs and QSTAGs can be obtained from Naval Publications Center 5801 Tabor Avenue Philadelphia, PA 19120. DA Form 1425 may be used to requisition documents.

TB 43-180. *Calibration Requirements for the Maintenance of Army Material.* 27 November 1992.

TM 6-230. *Logarithms and Mathematical tables.* 26 June 1956.

TM 9-1100 Series. *Operator and Organizational Manuals (Specific Systems).*

TM 9-1290-262-10. *Operator's manual for Aiming Circle, M2 (NSN 1290-00-614-0008) and M2A2 (NSN 1290-01-067-0687).* 15 April 1981.

TM 9-1300-200. *Ammunition, General.* 3 October 1969.

TM 9-6920-361-13&P. *Operator, Organizational and Direct Support Maintenance Manual (Including Repair Parts and Special Tools List): Field Artillery Trainer Kits (with Field Artillery Trainer M31).* 22 September 1976.

TM 43-0001-28-3. *Data Sheets for Guns, Howitzers, Mortars Interoperable Ammunition.* 29 September 1986.

TM 43-0001-28-4. *Artillery Ammunition: Authorized Projectile, Fuze, and Propelling Charge Combinations for Howitzer, Heavy Self-Propelled, 8-inch: M110A2, with Cannon M201A1.* 4 August 1988.

TM 43-0001-28-6. *Artillery Ammunition: Authorized Projectile, Fuze, and Propelling Charge Combinations for Howitzer, Medium, Self-Propelled 155mm: M109A3-A4 with Cannon M185.* 30 June 1993.

TM 43-0001-28-7. *Artillery Ammunition: Authorized Projectile, Fuze, and Propelling Charge Combinations for Howitzer, Medium, Towed, 155mm: M198 with Cannon M199.* 30 June 1993.

TM 43-0001-28-10. *Artillery Ammunition: Authorized Projectile, Fuze, and Propelling Charge Combinations for Howitzer, Light, Towed, 105mm: M101A1, and M102.* 31 August 1988.

TM 43-0001-28-13. *Artillery Ammunition: Authorized Projectile, Fuze, and Propelling Charge Combinations for Howitzer, Medium, Self-Propelled, 155mm: M109A5-A6 with Cannon M284.* 15 September 1994.

INDEX

- advance party, 2-4 through 2-6, 2-7
 - assembly, 2-4
 - major tasks, 2-5, 2-6
 - organization, 2-4
- aiming circle M2A2
 - care and handling, 4-6
 - components, 4-1, through 4-3
 - declination, 4-5
 - leveling, 4-3, 4-4
 - setting up, 4-3
 - taking down, 4-4
- ammunition
 - accidents, 10-7
 - care and handling, 10-3
 - field storage, 10-6, 10-7
 - interchangeability, App N
 - misfire procedures, 10-7
 - planning guide, 10-8 through 10-11
 - projectile description, 10-1 through 10-3
 - training, 10-7, 10-8, N-1
- battery position area
 - occupation, 2-12 through 2-17, 2-33 through 2-35
 - deliberate, 2-33
 - emergency, 2-33, 2-34
 - hasty, 2-33
 - types of, 2-33
 - preparation, 2-8, 2-12 through 2-15
 - day, 2-12 through 2-15
 - night, 2-15
 - RSOP operations, 2-2
 - selection considerations, 2-1, 2-8
 - types, 2-33
- boresighting, 8-3
- camouflage, 3-2, E-2, E-3
- case assembly, L-3, L-4
- characteristics of FA cannons, App M
- combat service support
 - maintenance, 12-3
 - responsibilities, 12-1
 - R3P site, 12-4
 - trains, 12-1
- common mistakes and malpractices, App D
- communications
 - radio systems, 9-4 through 9-8
 - small-unit transceiver, 9-8
 - wire system, 9-1 through 9-6
- compass, M2
 - care and handling, 4-11
 - components, 4-10
 - declination, 4-10
- crater analysis, J-1 through J-5
- defense, battery area
 - against
 - air attack, 3-1, 3-17, H-3
 - armor, 3-1, 3-17, H-2
 - dismounted attack, 3-1, 3-18
 - indirect fire, 3-1, 3-18
 - basic considerations, 3-2 through 3-6
 - camouflage, 3-2 through 3-6
 - checklist, App H
 - defense diagram, 3-9 through 3-16
 - emergency alarms, 3-21 through 3-23
 - equipment destruction procedures, 3-19, 3-20
 - howitzer range card, 3-14
 - machine gun range card, 3-15
 - responsibilities, 3-2
 - resources, 3-4, 3-5
- direct fire, 8-1 through 8-3
- duties of key personnel
 - battery commander, 1-4, 1-6, 2-5, 3-2, 11-1, 12-1
 - chief of firing battery, 1-9
 - executive officer, 1-8
 - fire direction officer, 1-5, 1-8, 11-1
 - first sergeant, 1-4, 1-8, 2-5, 3-2, 12-1
 - gunnery sergeant, 1-5, 1-9, 2-5

- platoon leader, 1-4, 3-2, 11-1
- platoon sergeant, 1-5, 3-2, 11-1
- section chief, 1-5, 1-9, 3-2, 3-8, 11-1
- evaluation, cannon section, App G
- fire commands
 - correcting, 7-7
 - elements, 7-2 through 7-7
 - examples, 7-8
 - repetition, 7-7
 - reports, 7-7
 - sequence, 7-1
 - special methods of fire, 7-6
 - standardizing, 7-7
- formations, battery, 2-10 through 2-12
- gun assembly, L-4, L-5
- gun display unit, App L
- Killer Junior, App I
- lay data, determining and reporting
 - correct azimuth/orienting angle, reporting, 4-24 through 4-27
 - correct deflection, reporting, 4-24
 - correcting boresighting error, 4-26
 - gun laying and positioning system, 4-8, 4-9
 - line of fire, measuring, 4-24 through 4-27
 - orienting angle, measuring, 4-24, 4-25, and 4-27
 - precision lightweight GPS receiver, 4-6 through 4-8
 - training, 4-27
- load plans, 2-20, App E
- marches and movements
 - close column, 2-18
 - contingencies, 2-22
 - control measures, 2-21
 - discipline, march, 2-21
 - halts, 2-22, and 2-26
 - infiltration, 2-19
 - loading plans, E-1
 - open column, 2-18
 - orders, 2-20
 - organization, 2-20
 - terrain march, 2-19
- minimum quadrant elevation
 - computation, 6-1, 6-2
 - fuze other than armed VT, 6-2, 6-3
 - piece-to-crest range, 6-2
 - VT fuzes, 6-3, 6-4
 - elements, 6-1
 - measuring, 6-2
 - angle of site to crest with
 - M2 compass, 6-2, 4-11
 - M2A2 aiming circle, 4-21
 - howitzer, 6-2
 - piece-to-crest range, 6-2
 - rapid fire tables, App K
- mission, 1-1
- operations other than war, F-6
- organization, battery
 - battery-based, 1-6
 - general, 1-1
 - platoon-based, 1-3
- rapid fire tables, App K
- reciprocal laying, 4-11 through 4-20
 - aiming point-deflection method, 4-17
 - commands, 4-15
 - establishing aiming points, 4-19
 - grid azimuth method, 4-14
 - howitzer back-lay method, 4-18
 - M2 compass method, 4-16
 - orienting angle method, 4-13
 - procedures, 4-12
 - training, 4-27
 - verifying, 4-20
- reconnaissance, 2-1 through 2-7
 - definition, 2-1
 - methods, 2-2, 2-3
 - planning, 2-3
 - RSOP considerations, 2-1
- safety during firing
 - computations, 11-4

duties of safety personnel, 11-2, O-21
general responsibilities, 11-1
safety aids, 11-3 through 11-4
safety test, App O

section chief's assembly, L-1 through L-3

shell fragment analysis, J-6 through J-9

shelling reports, 3-23, J-10, J-11

special operations, App F

standardization agreements
movements, 2-23
STANAGs/QSTAGs
2041/520, 2-23
2047/183, 3-21
2113/none, 3-19
2154/539, 2-23
2934/503, 3-24

standardized procedures, App A

survey techniques, hasty
automated computations, 5-22 through 5-25
determining altitude, 5-25
determining location, 5-13 through 5-23
directional traverse, 5-11
general, 5-1
measuring distance, 5-15 through 5-23
observation of Polaris, 5-2 through 5-10
simultaneous observation, 5-1, 5-2
subtense tables, 5-17 through 5-23

tests
cannon section, App G
gunner's qualification, App B
safety personnel qualification, App O

threat capabilities, 3-1

troop leading procedures, 2-1
